

TOSHIBA

SERVICE MANUAL

AIR-CONDITIONER

SPLIT TYPE

Indoor Unit

<High Wall, Heat Pump Type>

Outdoor Unit

<Heat Pump Type>

RAS-25N4KVPG-ND / RAS-25N4AVPG-ND
RAS-35N4KVPG-ND / RAS-35N4AVPG-ND

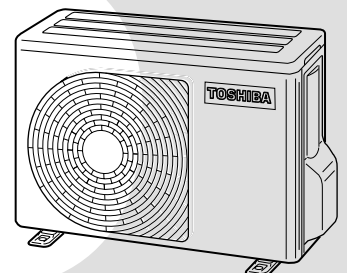
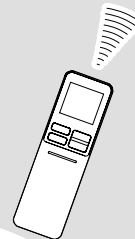

R32





INVERTER



CONTENTS

| | |
|---|-----|
| 1. SAFETY PRECAUTIONS | 3 |
| 2. SPECIFICATIONS | 6 |
| 3. REFRIGERANT R32 | 8 |
| 4. CONSTRUCTION VIEWS | 16 |
| 5. WIRING DIAGRAM | 18 |
| 6. SPECIFICATIONS OF ELECTRICAL PARTS | 19 |
| 7. REFRIGERANT CYCLE DIAGRAM | 20 |
| 8. CONTROL BLOCK DIAGRAM | 23 |
| 9. OPERATION DESCRIPTION | 25 |
| 10. INSTALLATION PROCEDURE | 63 |
| 11. HOW TO DIAGNOSE THE TROUBLE | 80 |
| 12. HOW TO REPLACE THE MAIN PARTS | 106 |
| 13. EXPLODED VIEWS AND PARTS LIST | 124 |

1. SAFETY PRECAUTIONS

| | | | |
|---|---|---|---|
|  | <p>Read the precautions in this manual carefully before operating the unit.</p> |  | <p>This appliance is filled with R32. (Flammable Material)</p> |
|  | <p>Information included in the Operation Manual and/or Installation Manual.</p> |  | <p>Service personnel should be handling this equipment with reference to the Installation Manual.</p> |

For general public use

Power supply cord of outdoor unit shall be more than 1.5 mm² (H07RN-F or 60245IEC66) polychloroprene sheathed flexible cord.

- Read this “SAFETY PRECAUTIONS” carefully before servicing.
- The precautions described below include the important items regarding safety. Observe them without fail.
- After the servicing work, perform a trial operation to check for any problem.
- Turn off the main power supply switch (or breaker) before the unit maintenance.

■ Important information regarding the refrigerant used

This product contains fluorinated greenhouse gases covered by the Kyoto Protocol. Do not vent gases into the atmosphere. Refrigerant type: **R32**

GWP⁽¹⁾ value: **675***

⁽¹⁾GWP = global warming potential

The refrigerant quantity is indicated on the unit name plate.

* This value is based on F gas regulation 517/2014

CAUTION

New Refrigerant Air Conditioner Installation

- **THIS AIR CONDITIONER ADOPTS THE NEW HFC REFRIGERANT (R32) WHICH DOES NOT DESTROY OZONE LAYER.**

R32 refrigerant is apt to be affected by impurities such as water, oxidizing membrane, and oils because the working pressure of R32 refrigerant is approx. 1.6 times of refrigerant R22. Accompanied with the adoption of the new refrigerant, the refrigeration machine oil has also been changed. Therefore, during installation work, be sure that water, dust, former refrigerant, or refrigeration machine oil does not enter into the new type refrigerant R32 air conditioner circuit.

To prevent mixing of refrigerant or refrigerating machine oil, the sizes of connecting sections of charging port on main unit and installation tools are different from those used for the conventional refrigerant units.

Accordingly, special tools are required for the new refrigerant (R32) units. For connecting pipes, use new and clean piping materials with high pressure fittings made for R32 only, so that water and/or dust does not enter. Moreover, do not use the existing piping because there are some problems with pressure fittings and possible impurities in existing piping.

CAUTION

TO DISCONNECT THE APPLIANCE FROM THE MAIN POWER SUPPLY

This appliance must be connected to the main power supply by a circuit breaker or a switch with a contact separation of at least 3 mm.

DANGER

- **ASK AN AUTHORIZED DEALER OR QUALIFIED INSTALLATION PROFESSIONAL TO INSTALL/MAINTAIN THE AIR CONDITIONER.**

INAPPROPRIATE SERVICING MAY RESULT IN WATER LEAKAGE, ELECTRIC SHOCK OR FIRE.

- **TURN OFF MAIN POWER SUPPLY BEFORE ATTEMPTING ANY ELECTRICAL WORK. MAKE SURE ALL POWER SWITCHES ARE OFF. FAILURE TO DO SO MAY CAUSE ELECTRIC SHOCK.**



DANGER: HIGH VOLTAGE

The high voltage circuit is incorporated.

Be careful to do the check service, as the electric shock may be caused in case of touching parts on the P.C. board by hand.

- **CORRECTLY CONNECT THE CONNECTING CABLE. IF THE CONNECTING CABLE IS INCORRECTLY CONNECTED, ELECTRIC PARTS MAY BE DAMAGED.**
- **CHECK THAT THE EARTH WIRE IS NOT BROKEN OR DISCONNECTED BEFORE SERVICE AND INSTALLATION. FAILURE TO DO SO MAY CAUSE ELECTRIC SHOCK.**
- **DO NOT INSTALL NEAR CONCENTRATIONS OF COMBUSTIBLE GAS OR GAS VAPORS. FAILURE TO FOLLOW THIS INSTRUCTION CAN RESULT IN FIRE OR EXPLOSION.**
- **TO PREVENT THE INDOOR UNIT FROM OVERHEATING AND CAUSING A FIRE HAZARD, PLACE THE UNIT WELL AWAY (MORE THAN 2 M) FROM HEAT SOURCES SUCH AS RADIATORS, HEAT REGISTORS, FURNACE, STOVES, ETC.**
- **WHEN MOVING THE AIR-CONDITIONER FOR INSTALLATION IN ANOTHER PLACE, BE VERY CAREFUL NOT TO ALLOW THE SPECIFIED REFRIGERANT (R410A) TO BECOME MIXED WITH ANY OTHER GASEOUS BODY INTO THE REFRIGERATION CIRCUIT. IF AIR OR ANY OTHER GAS IS MIXED IN THE REFRIGERANT, THE GAS PRESSURE IN THE REFRIGERATION CIRCUIT WILL BECOME ABNORMALLY HIGH AND IT MAY RESULT IN THE PIPE BURSTING AND POSSIBLE PERSONNEL INJURIES.**
- **IN THE EVENT THAT THE REFRIGERANT GAS LEAKS OUT OF THE PIPE DURING THE SERVICE WORK AND THE INSTALLATION WORK, IMMEDIATELY LET FRESH AIR INTO THE ROOM. IF THE REFRIGERANT GAS IS HEATED, SUCH AS BY FIRE, GENERATION OF POISONOUS GAS MAY RESULT.**

WARNING

- **Never modify this unit by removing any of the safety guards or bypass any of the safety interlock switches.**
- **Do not install in a place which cannot bear the weight of the unit. Personal injury and property damage can result if the unit falls.**
- **After the installation work, confirm that refrigerant gas does not leak.**
If refrigerant gas leaks into the room and flows near a fire source, such as a cooking range, noxious gas may generate.
- **The electrical work must be performed by a qualified electrician in accordance with the Installation Manual. Make sure the air conditioner uses an exclusive circuit.**
An insufficient circuit capacity or inappropriate installation may cause fire.
- **When wiring, use the specified cables and connect the terminals securely to prevent external forces applied to the cable from affecting the terminals.**
- **Be sure to provide grounding.**
Do not connect ground wires to gas pipes, water pipes, lightning rods or ground wires for telephone cables.
- **Conform to the regulations of the local electric company when wiring the power supply.**
Inappropriate grounding may cause electric shock.
- **Manufacturer pay no responsibility to any damage, caused by heating cable, being outside of unit.**

- Do not pierce or burn as the appliance is pressurized. Do not expose the appliance to heat, flame, sparks, or other sources of ignition. Else, it may explode and cause injury or death.
- For R32 model, use pipes, flare nut and tools which is specified for R32 refrigerant. Using of existing (R22) piping, flare nut and tools may cause abnormally high pressure in the refrigerant cycle (piping), and possibly result in explosion and injury.
- Thickness of copper pipes used R32 must be more than 0.8mm. Never use copper pipes thinner than 0.8mm.
- Do not perform flare connection inside a building or dwelling or room, when joining the heat exchanger of indoor unit with interconnection piping. Refrigerant connection inside a building or dwelling or room must be made by brazing or welding. Joint connection of indoor unit by flaring method can only be made at outdoor or at outside of building or dwelling or room. Flare connection may cause gas leak and flammable atmosphere.
- After completion of installation or service, confirm there is no leakage of refrigerant gas. It may generate toxic gas when the refrigerant contacts with fire.
- Comply with national gas regulations.

CAUTION

- Exposure of unit to water or other moisture before installation may result in an electrical short. Do not store in a wet basement or expose to rain or water.
- Do not install in a place that can increase the vibration of the unit. Do not install in a place that can amplify the noise level of the unit or where noise or discharged air might disturb neighbors.
- To avoid personal injury, be careful when handling parts with sharp edges.
- **Perform the specified installation work to guard against an earthquake.**
If the air conditioner is not installed appropriately, accidents may occur due to the falling unit.

For Reference:

If a heating operation would be continuously performed for a long time under the condition that the outdoor temperature is 0°C or lower, drainage of defrosted water may be difficult due to freezing of the bottom plate, resulting in a trouble of the cabinet or fan.

It is recommended to procure an antifreeze heater locally for a safe installation of the air conditioner.

For details, contact the dealer.

2. SPECIFICATIONS

2-1. Specification

| | | | | | | | |
|--------------------------|-----------------------------------|--|--|----------------|------------------------|----------------|----------------|
| Unit model | Indoor | | RAS-25N4KVPG-ND | | RAS-35N4KVPG-ND | | |
| | Outdoor | | RAS-25N4AVPG-ND | | RAS-35N4AVPG-ND | | |
| Cooling capacity | (kW) | | 2.50 | | 3.50 | | |
| Cooling capacity range | (kW) | | 0.75-3.50 | | 0.90-4.10 | | |
| Heating capacity | (kW) | | 3.20 | | 4.00 | | |
| Heating capacity range | (kW) | | 0.70-6.70 | | 0.90-7.70 | | |
| Power supply | 1Ph, 220-240V, 50Hz | | | | | | |
| Electric characteristic | Indoor | Operation mode | | Cooling | Heating | | |
| | | Running current (A) | 0.24-0.22 | 0.28-0.26 | 0.24-0.22 | 0.28-0.26 | |
| | | Power consumption (W) | 25 | 30 | 25 | 30 | |
| | | | Power factor (%) | 47 | 48 | 47 | 48 |
| | Outdoor | Operation mode | | Cooling | Heating | Cooling | Heating |
| | | Running current (A) | 2.32-2.13 | 3.12-2.85 | 3.91-3.58 | 4.02-3.68 | |
| | | Power consumption (W) | 415 | 570 | 745 | 770 | |
| | | Power factor (%) | 81 | 83 | 87 | 87 | |
| | | | Starting current (A) | - | - | - | - |
| COP (Cooling / Heating) | | | 5.68/5.33 | | 4.55/5.00 | | |
| Operating noise | Indoor | High | (Cooling / Heating) | (dB-A) | 42/44 | | |
| | | Medium | (Cooling / Heating) | (dB-A) | 33/33 | | |
| | | Low | (Cooling / Heating) | (dB-A) | 24/24 | | |
| | Outdoor | (Cooling / Heating) | | (dB-A) | 46/47 | | |
| Indoor unit | Unit model | | RAS-25N4KVPG-ND | | RAS-35N4KVPG-ND | | |
| | Dimension | Height (mm) | 293 | | 293 | | |
| | | Width (mm) | 851 | | 851 | | |
| | | Depth (mm) | 270 | | 270 | | |
| | Net weight (kg) | 14 | | 14 | | | |
| | Fan motor output (W) | 42 | | 42 | | | |
| | Air flow rate (Cooling / Heating) | | (m ³ / min) | 11.2/12.1 | | 11.2/12.1 | |
| Outdoor unit | Unit model | | RAS-25N4AVPG-ND | | RAS-35N4AVPG-ND | | |
| | Dimension | Height (mm) | 630 | | 630 | | |
| | | Width (mm) | 800 | | 800 | | |
| | | Depth (mm) | 300 | | 300 | | |
| | Net weight (kg) | 42 | | 43 | | | |
| | Compressor | Motor output (W) | 900 | | 1050 | | |
| | | Type | Twin rotary type with DC-inverter variable speed control | | | | |
| | | Model | KTN150D63UFZ3 | | KTM180D68UFZ | | |
| | Fan motor output (W) | 70 | | | | | |
| | Air flow rate (Cooling / Heating) | | (m ³ / min) | 36/36 | | 42/42 | |
| Piping connection | Type | | Flare connection | | | | |
| | Indoor unit | Liquid side (mm) | Ø6.35 | | | | |
| | | Gas side (mm) | Ø9.52 | | | | |
| | Outdoor unit | Liquid side (mm) | Ø6.35 | | | | |
| | | Gas side (mm) | Ø9.52 | | | | |
| | Maximum length (m) | | 25 | | | | |
| | Maximum charge-less length (m) | | 15 | | | | |
| | Maximum height difference (m) | | 10 | | | | |
| Refrigerant | Name of refrigerant | | R32 | | | | |
| | Weight (kg) | | 1.10 | | | | |
| Wiring connection | Power supply | | 3 Wires: Includes earth (Outdoor) | | | | |
| | Interconnection | | 4 Wires: Includes earth | | | | |
| Usable temperature range | Indoor (Cooling / Heating) (°C) | 21-32/ -28 | | | | | |
| | Outdoor (Cooling / Heating) (°C) | -15-46/-30-24 | | | | | |
| Accessory | Indoor unit | Installation plate | 1 | | | | |
| | | Wireless remote controller | 1 | | | | |
| | | Batteries | 2 | | | | |
| | | Remote controller holder | 1 | | | | |
| | | Toshiba IAQ filter | 1 | | | | |
| | | Mounting screw | 6(Ø4x25L) | | | | |
| | | Remote controller holder Flat head wood screw | 2(Ø3.1x16L) | | | | |
| | | Installation manual | 1 | | | | |
| | | Owner's manual | 1 | | | | |

* The specification may be subject to change without notice for purpose of improvement.

2-2. Operation Characteristic Curve.

<Cooling>

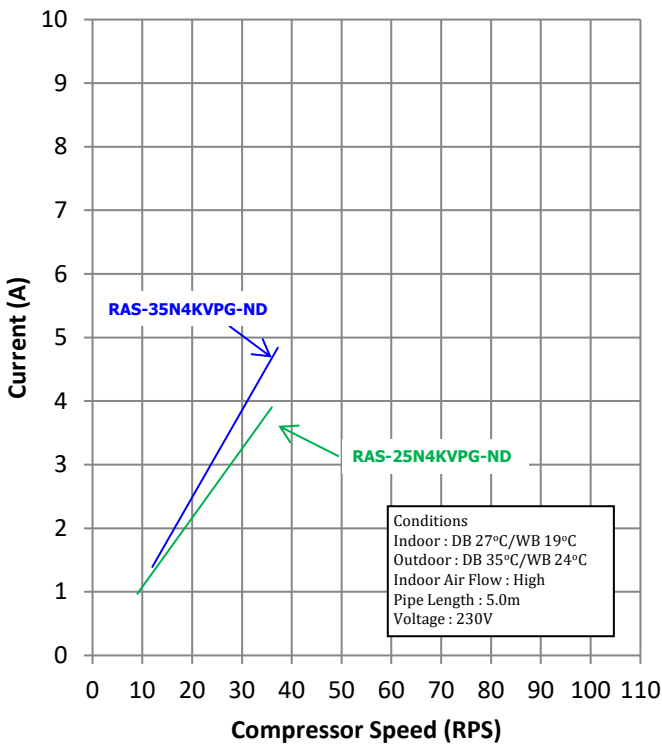

<Heating>

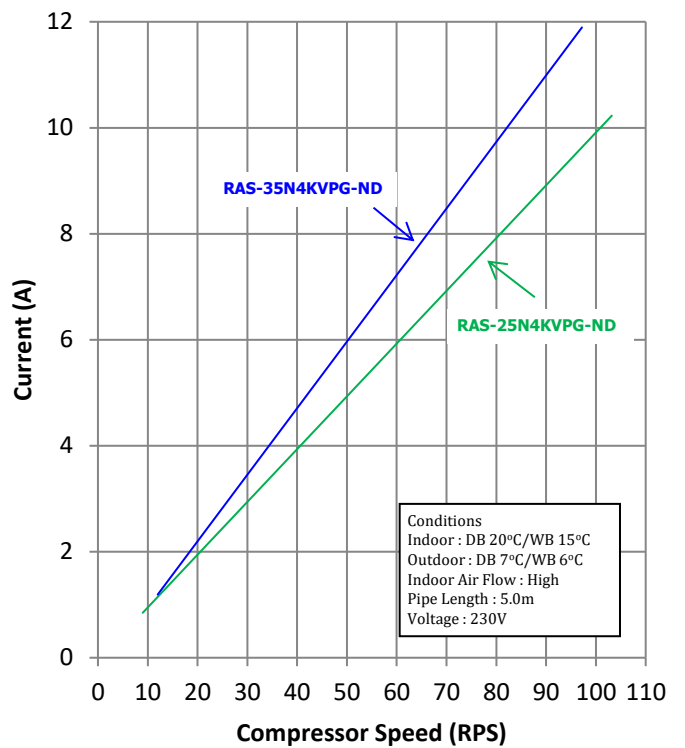

2-3. Capacity Variation ratio According to Temperature.

<Cooling>

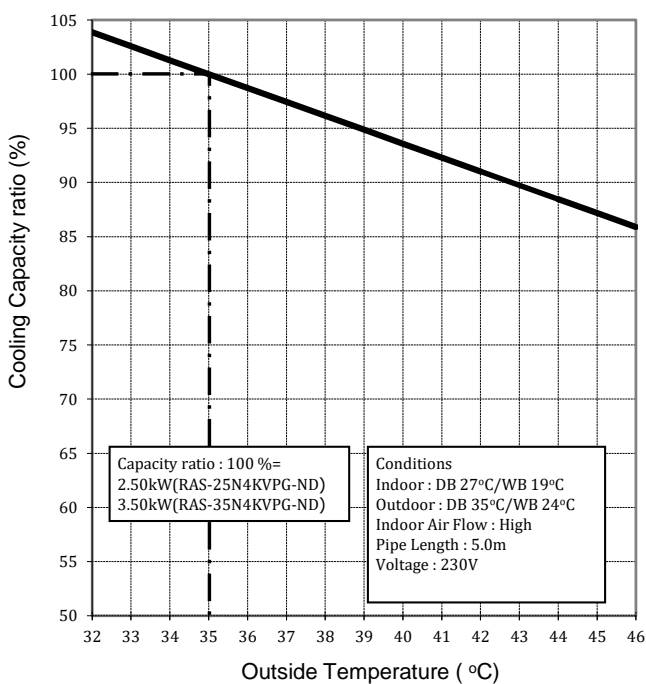

<Heating>

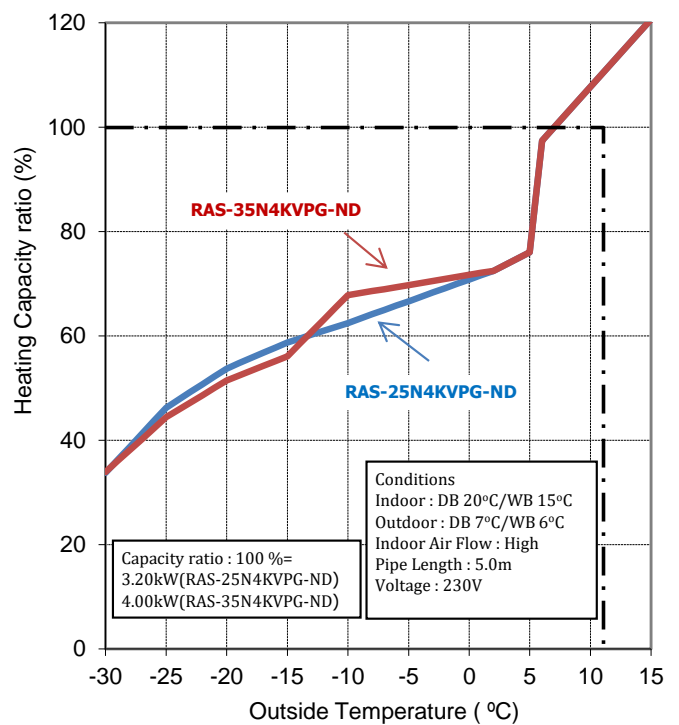

3. REFRIGERANT R32

This air conditioner adopts the new refrigerant HFC (R32) which does not damage the ozone layer.

The next section describes the precautions for air conditioner using the new refrigerant. Conforming to contents of the next section together with the general cautions included in this manual, perform the correct and safe work.

3-1. Safety During Installation/Service

The basic installation servicing work procedures are the same as conventional R410A models.

As R32's pressure is about 1.6 times higher than that of R22, improper installation/servicing may cause a serious trouble. By using tools and materials exclusive for R32, it is necessary to carry out installation/servicing safely while taking the following precautions into consideration.

1. Never use refrigerant other than R32 in an air conditioner which is designed to operate with R32. If other refrigerant than R32 is mixed, pressure in the refrigeration cycle becomes abnormally high, and it may cause personal injury, etc. by a rupture.
2. Confirm the used refrigerant name, and use tools and materials exclusive for the refrigerant. The refrigerant name R32 is indicated on the visible place of the outdoor unit of the air conditioner using R32 as refrigerant. To prevent mischarging, the diameter of the service port differs from that of R22. R32 and other HFCs are heavier than air, and therefore they are inclined to settle near the floor surface. If the gas fills up the room or the bottom part of a room, it may also cause oxygen deficiency and may reach its combustion concentration.

In order to prevent oxygen deficiency and R32 combustion, keep the room well-ventilated for a healthy work environment.

In particular, using HFCs in a basement room or confined area creates a higher risk; be sure to furnish the room with local exhaust ventilation. If a refrigerant leak is confirmed in a room an inadequately ventilated location, do not use a flame until the area has been ventilated appropriately and the work environment has been improved.

The same applies in case of brazing, ensure appropriate ventilation to prevent oxygen deficiency and R32 combustion.

Check that there are no dangerous or combustible items nearby, and ensure a fire extinguisher is close at hand.

Keep a sufficient distance away from causes of fire (ignition sources) such as gas-burning equipment and electric heaters in places where installation, repairs, or similar work on air-conditioning equipment is performed.

3. If a refrigeration gas leakage occurs during installation/servicing, be sure to ventilate fully. If the refrigerant gas comes into contact with fire, a poisonous gas may occur.
4. When installing or removing an air conditioner, do not allow air moisture dust or oil to remain in the refrigeration cycle. Otherwise, pressure in the refrigeration cycle may become abnormally high so that a rupture or personal injury may be caused.
5. After completion of installation work, check to make sure that there is no refrigeration gas leakage. If the refrigerant gas leaks into the room, coming into contact with fire in the fan-driven heater, space heater, etc., a poisonous gas may occur
6. When an air conditioning system charged with a large volume of refrigerant is installed in a small room, it is necessary to exercise care so that, even when refrigerant leaks, its concentration does not exceed the marginal level. If the refrigerant gas leakage occurs and its concentration exceeds the marginal level, an oxygen starvation accident may result.
7. Be sure to carry out installation or removal according to the installation manual. Improper installation may cause refrigeration trouble, water leakage, electric shock, fire, etc.
8. Unauthorized modifications to the air conditioner may be dangerous. If a breakdown occurs please call a qualified air conditioner technician or electrician. Improper repair's may result in water leakage, electric shock and fire, etc.

3-2. Refrigerant Piping Installation

3-2-1. Piping Materials and Joints Used

For the refrigerant piping installation, copper pipes and joints are mainly used. Copper pipes and joints suitable for the refrigerant must be chosen and installed. Furthermore, it is necessary to use clean copper pipes and joints whose interior surfaces are less affected by contaminants.

1. Copper Pipes

It is necessary to use seamless copper pipes which are made of either copper or copper alloy and it is desirable that the amount of residual oil is less than 40 mg/10 m. Do not use copper pipes having a collapsed, deformed or discolored portion (especially on the interior surface).

Otherwise, the expansion valve or capillary tube may become blocked with contaminants.

As an air conditioner using R32 incurs pressure higher than when using R22, it is necessary to choose adequate materials.

Thicknesses of copper pipes used with R32 are as shown in Table 3-2-1. Never use copper pipes thinner than 0.8 mm even when it is available on the market.

Table 3-2-1 Thicknesses of annealed copper pipes

| | | Thickness (mm) | |
|------------------|---------------------|----------------|------|
| Nominal diameter | Outer diameter (mm) | R32(R410A) | R22 |
| 1/4 | 6.35 | 0.80 | 0.80 |
| 3/8 | 9.52 | 0.80 | 0.80 |
| 1/2 | 12.70 | 0.80 | 0.80 |
| 5/8 | 15.88 | 1.00 | 1.00 |

2. Joints

For copper pipes, flare joints or socket joints are used. Prior to use, be sure to remove all contaminants.

a) Flare Joints

Flare joints used to connect the copper pipes cannot be used for pipings whose outer diameter exceeds 20 mm. In such a case, socket joints can be used.

Sizes of flare pipe ends, flare joint ends and flare nuts are as shown in Tables 3-2-3 to 3-2-6 below.

b) Socket Joints

Socket joints are such that they are brazed for connections, and used mainly for thick pipings whose diameter is larger than 20 mm.

Thicknesses of socket joints are as shown in Table 3-2-2.

Table 3-2-2 Minimum thicknesses of socket joints

| Nominal diameter | Reference outer diameter of copper pipe jointed (mm) | Minimum joint thickness (mm) |
|------------------|--|------------------------------|
| 1/4 | 6.35 | 0.50 |
| 3/8 | 9.52 | 0.60 |
| 1/2 | 12.70 | 0.70 |
| 5/8 | 15.88 | 0.80 |

3-2-2. Processing of Piping Materials

When performing the refrigerant piping installation, care should be taken to ensure that water or dust does not enter the pipe interior, that no other oil than lubricating oils used in the installed air-water heat pump is used, and that refrigerant does not leak. When using lubricating oils in the piping processing, use such lubricating oils whose water content has been removed. When stored, be sure to seal the container with an airtight cap or any other cover.

1. Flare processing procedures and precautions

a) Cutting the Pipe

By means of a pipe cutter, slowly cut the pipe so that it is not deformed.

b) Removing Burrs and Chips

If the flared section has chips or burrs, refrigerant leakage may occur.

Carefully remove all burrs and clean the cut surface before installation.

c) Insertion of Flare Nut

d) Flare Processing

Make certain that a clamp bar and copper pipe have been cleaned.

By means of the clamp bar, perform the flare processing correctly.

Use either a flare tool for R32 or conventional flare tool.

Flare processing dimensions differ according to the type of flare tool. When using a conventional flare tool, be sure to secure "dimension A" by using a gauge for size adjustment.

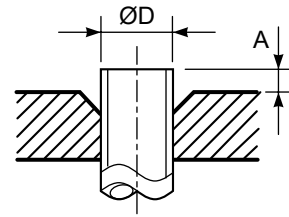

Fig. 3-2-1 Flare processing dimensions

Table 3-2-3 Dimensions related to flare processing for R32(R410A)

| Nominal diameter | Outer diameter (mm) | Thickness (mm) | A (mm) | | |
|------------------|---------------------|----------------|--------------------------------|-------------------------|---------------|
| | | | Flare tool for R32 clutch type | Conventional flare tool | |
| | | | | Clutch type | Wing nut type |
| 1/4 | 6.35 | 0.8 | 0 to 0.5 | 1.0 to 1.5 | 1.5 to 2.0 |
| 3/8 | 9.52 | 0.8 | 0 to 0.5 | 1.0 to 1.5 | 1.5 to 2.0 |
| 1/2 | 12.70 | 0.8 | 0 to 0.5 | 1.0 to 1.5 | 2.0 to 2.5 |
| 5/8 | 15.88 | 1.0 | 0 to 0.5 | 1.0 to 1.5 | 2.0 to 2.5 |

Table 3-2-4 Dimensions related to flare processing for R22

| Nominal diameter | Outer diameter (mm) | Thickness (mm) | A (mm) | | |
|------------------|---------------------|----------------|--------------------------------|-------------------------|---------------|
| | | | Flare tool for R22 clutch type | Conventional flare tool | |
| | | | | Clutch type | Wing nut type |
| 1/4 | 6.35 | 0.8 | 0 to 0.5 | 0.5 to 1.0 | 1.0 to 1.5 |
| 3/8 | 9.52 | 0.8 | 0 to 0.5 | 0.5 to 1.0 | 1.0 to 1.5 |
| 1/2 | 12.70 | 0.8 | 0 to 0.5 | 0.5 to 1.0 | 1.5 to 2.0 |
| 5/8 | 15.88 | 1.0 | 0 to 0.5 | 0.5 to 1.0 | 1.5 to 2.0 |

Table 3-2-5 Flare and flare nut dimensions for R32(R410A)

| Nominal diameter | Outer diameter (mm) | Thickness (mm) | Dimension (mm) | | | | Flare nut width (mm) |
|------------------|---------------------|----------------|----------------|------|------|----|----------------------|
| | | | A | B | C | D | |
| 1/4 | 6.35 | 0.8 | 9.1 | 9.2 | 6.5 | 13 | 17 |
| 3/8 | 9.52 | 0.8 | 13.2 | 13.5 | 9.7 | 20 | 22 |
| 1/2 | 12.70 | 0.8 | 16.6 | 16.0 | 12.9 | 23 | 26 |
| 5/8 | 15.88 | 1.0 | 19.7 | 19.0 | 16.0 | 25 | 29 |

Table 3-2-6 Flare and flare nut dimensions for R22

| Nominal diameter | Outer diameter (mm) | Thickness (mm) | Dimension (mm) | | | | Flare nut width (mm) |
|------------------|---------------------|----------------|----------------|------|------|----|----------------------|
| | | | A | B | C | D | |
| 1/4 | 6.35 | 0.8 | 9.0 | 9.2 | 6.5 | 13 | 17 |
| 3/8 | 9.52 | 0.8 | 13.0 | 13.5 | 9.7 | 20 | 22 |
| 1/2 | 12.70 | 0.8 | 16.2 | 16.0 | 12.9 | 20 | 24 |
| 5/8 | 15.88 | 1.0 | 19.7 | 19.0 | 16.0 | 23 | 27 |
| 3/4 | 19.05 | 1.0 | 23.3 | 24.0 | 19.2 | 34 | 36 |

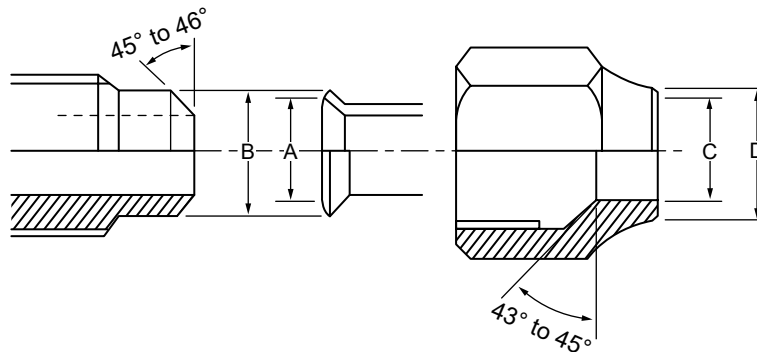

Fig. 3-2-2 Relations between flare nut and flare seal surface

2. Flare Connecting Procedures and Precautions

- Make sure that the flare and union portions do not have any scar or dust, etc.
- Correctly align the processed flare surface with the union axis.
- Tighten the flare with designated torque by means of a torque wrench. The tightening torque for R32 is the same as that for conventional R22. Incidentally, when the torque is weak, the gas leakage may occur. When it is strong, the flare nut may crack and may be made non-removable. When choosing the tightening torque, comply with values designated by manufacturers. Table 3-2-7 shows reference values.

NOTE :

When applying oil to the flare surface, be sure to use oil designated by the manufacturer. If any other oil is used, the lubricating oils may deteriorate and cause the compressor to burn out.

Table 3-2-7 Tightening torque of flare for R32(R410A) [Reference values]

| Nominal diameter | Outer diameter (mm) | Tightening torque N•m (kgf•cm) | Tightening torque of torque wrenches available on the market N•m (kgf•cm) |
|------------------|---------------------|--------------------------------|---|
| 1/4 | 6.35 | 14 to 18 (140 to 180) | 16 (160), 18 (180) |
| 3/8 | 9.52 | 33 to 42 (330 to 420) | 42 (420) |
| 1/2 | 12.70 | 50 to 62 (500 to 620) | 55 (550) |
| 5/8 | 15.88 | 63 to 77 (630 to 770) | 65 (650) |

3-3. Tools

3-3-1. Required Tools

The service port diameter of packed valve of the outdoor unit in the air-water heat pump using R32 is changed to prevent mixing of other refrigerant. To reinforce the pressure-resisting strength, flare processing dimensions and opposite side dimension of flare nut (For Ø12.7 copper pipe) of the refrigerant piping are lengthened.

The used refrigerating oil is changed, and mixing of oil may cause a trouble such as generation of sludge, clogging of capillary, etc. Accordingly, the tools to be used are classified into the following three types.

1. Tools exclusive for R32 (Those which cannot be used for conventional refrigerant (R22))
2. Tools exclusive for R32, but can be also used for conventional refrigerant (R22)
3. Tools commonly used for R32 and for conventional refrigerant (R22)

The table below shows the tools exclusive for R32 and their interchangeability.

Tools exclusive for R32 (The following tools for R410A are required.)

Tools whose specifications are changed for R32 and their interchangeability

| No. | Used tool | Usage | R32(R410A) air-water heat pump installation | | Conventional air-water heat pump installation |
|-----|---|--|--|--|---|
| | | | Existence of new equipment for R32 | Whether conven- tional equipment can be used | Whether new equipment can be used with conventional refrigerant |
| 1 | Flare tool | Pipe flaring | Yes | *(Note 1) | ○ |
| 2 | Copper pipe gauge for adjusting projection margin | Flaring by conventional flare tool | Yes | *(Note 1) | *(Note 1) |
| 3 | Torque wrench (For Ø12.7) | Connection of flare nut | Yes | ✕ | ✕ |
| 4 | Gauge manifold | Evacuating, refrigerant charge, run check, etc. | Yes | ✕ | ✕ |
| 5 | Charge hose | | | | |
| 6 | Vacuum pump adapter | Vacuum evacuating | Yes | ✕ | ○ |
| 7 | Electronic balance for refrigerant charging | Refrigerant charge | Yes | ✕ | ○ |
| 8 | Leakage detector | Gas leakage check | Yes | ✕ | ○ |

(Note 1) When flaring is carried out for R32(R410A) using the conventional flare tools, adjustment of projection margin is necessary. For this adjustment, a copper pipe gauge, etc. are necessary.

General tools (Conventional tools can be used.)

In addition to the above exclusive tools, the following equipments which serve also for R22 are necessary as the general tools.

- | | | |
|--|-----------------------------|---|
| 1. Vacuum pump Use vacuum pump by attaching vacuum pump adapter. | 4. Reamer | 9. Hole core drill (Ø65) |
| 2. Torque wrench (For Ø6.35, Ø9.52) | 5. Pipe bender | 10. Hexagon wrench (Opposite side 4mm) |
| 3. Pipe cutter | 6. Level vial | 11. Tape measure |
| | 7. Screwdriver (+, -) | 12. Metal saw |
| | 8. Spanner or Monkey wrench | |

Also prepare the following equipments for other installation method and run check.

- | | |
|----------------|---------------------------------|
| 1. Clamp meter | 3. Insulation resistance tester |
| 2. Thermometer | 4. Electroscop |

3-4. Recharging of Refrigerant

When it is necessary to recharge refrigerant, charge the specified amount of new refrigerant according to the following steps.

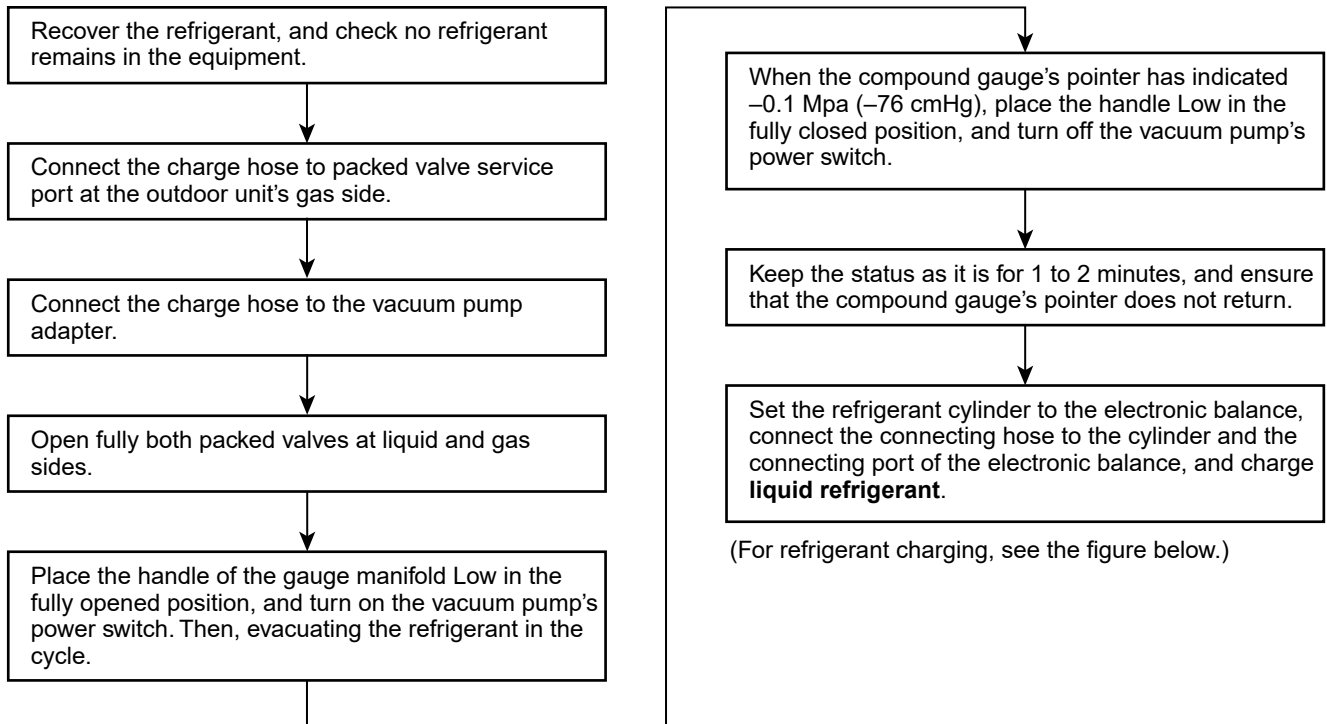

1. Never charge refrigerant exceeding the specified amount.
2. If the specified amount of refrigerant cannot be charged, charge refrigerant **bit by bit** in COOL mode.
3. Do not carry out additional charging.

When additional charging is carried out if refrigerant leaks, the refrigerant composition changes in the refrigeration cycle, that is characteristics of the air conditioner changes, refrigerant exceeding the specified amount is charged, and working pressure in the refrigeration cycle becomes abnormally high pressure, and may cause a rupture or personal injury.

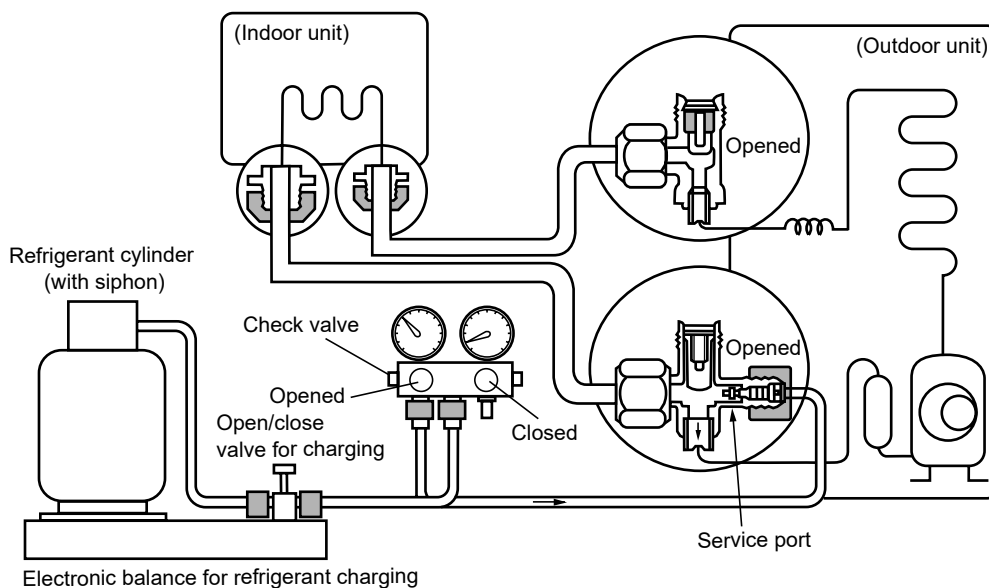

Fig. 3-4-1 Configuration of refrigerant charging

1. Be sure to make setting so that **liquid** can be charged.
2. When using a cylinder equipped with a siphon, liquid can be charged without turning it upside down.

Accordingly, when charging refrigerant from the refrigerant cylinder to the equipment, charge it turning the cylinder upside down if cylinder is not equipped with siphon.

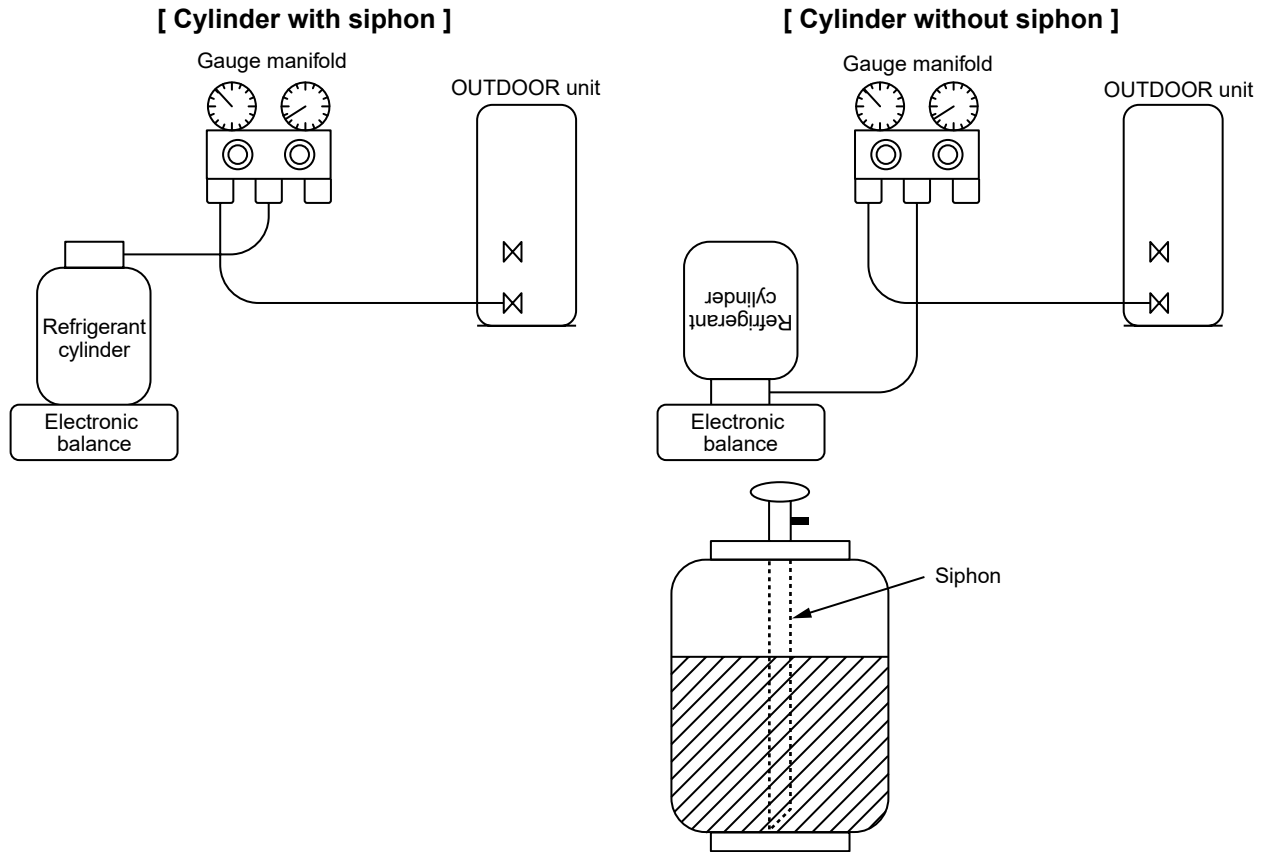

Fig. 3-4-2

3-5. Brazing of Pipes

3-5-1. Materials for Brazing

1. Silver brazing filler

Silver brazing filler is an alloy mainly composed of silver and copper. It is used to join iron, copper or copper alloy, and is relatively expensive though it excels in solderability.

2. Phosphor bronze brazing filler

Phosphor bronze brazing filler is generally used to join copper or copper alloy.

3. Low temperature brazing filler

Low temperature brazing filler is generally called solder, and is an alloy of tin and lead. Since it is weak in adhesive strength, do not use it for refrigerant pipes.

1. Phosphor bronze brazing filler tends to react with sulfur and produce a fragile compound water solution, which may cause a gas leakage. Therefore, use any other type of brazing filler at a hot spring resort, etc., and coat the surface with a paint.
2. When performing brazing again at time of servicing, use the same type of brazing filler.

3-5-2. Flux

1. Reason why flux is necessary

- By removing the oxide film and any foreign matter on the metal surface, it assists the flow of brazing filler.
- In the brazing process, it prevents the metal surface from being oxidized.
- By reducing the brazing filler's surface tension, the brazing filler adheres better to the treated metal.

2. Characteristics required for flux

- Activated temperature of flux coincides with the brazing temperature.
- Due to a wide effective temperature range, flux is hard to carbonize.
- It is easy to remove slag after brazing.
- The corrosive action to the treated metal and brazing filler is minimum.
- It excels in coating performance and is harmless to the human body.

As the flux works in a complicated manner as described above, it is necessary to select an adequate type of flux according to the type and shape of treated metal, type of brazing filler and brazing method, etc.

3. Types of flux

• Noncorrosive flux

Generally, it is a compound of borax and boric acid.

It is effective in case where the brazing temperature is higher than 800°C.

• Activated flux

Most of fluxes generally used for silver brazing are this type.

It features an increased oxide film removing capability due to the addition of compounds such as potassium fluoride, potassium chloride and sodium fluoride to the borax-boric acid compound.

4. Piping materials for brazing and used brazing filler/flux

| Piping material | Used brazing filler | Used flux |
|-----------------|---------------------|------------|
| Copper - Copper | Phosphor copper | Do not use |
| Copper - Iron | Silver | Paste flux |
| Iron - Iron | Silver | Vapor flux |

1. Do not enter flux into the refrigeration cycle.
2. When chlorine contained in the flux remains within the pipe, the lubricating oil deteriorates. Therefore, use a flux which does not contain chlorine.
3. When adding water to the flux, use water which does not contain chlorine (e.g. distilled water or ion-exchange water).
4. Remove the flux after brazing.

3-5-3. Brazing

As brazing work requires sophisticated techniques, experiences based upon a theoretical knowledge, it must be performed by a person qualified.

In order to prevent the oxide film from occurring in the pipe interior during brazing, it is effective to proceed with brazing while letting dry Nitrogen gas (N₂) flow.

Never use gas other than Nitrogen gas.

1. Brazing method to prevent oxidation

- 1) Attach a reducing valve and a flow-meter to the Nitrogen gas cylinder.
- 2) Use a copper pipe to direct the piping material, and attach a flow-meter to the cylinder.
- 3) Apply a seal onto the clearance between the piping material and inserted copper pipe for Nitrogen in order to prevent backflow of the Nitrogen gas.
- 4) When the Nitrogen gas is flowing, be sure to keep the piping end open.
- 5) Adjust the flow rate of Nitrogen gas so that it is lower than 0.05 m³/Hr or 0.02 MPa (0.2kgf/cm²) by means of the reducing valve.
- 6) After performing the steps above, keep the Nitrogen gas flowing until the pipe cools down to a certain extent (temperature at which pipes are touchable with hands).
- 7) Remove the flux completely after brazing.

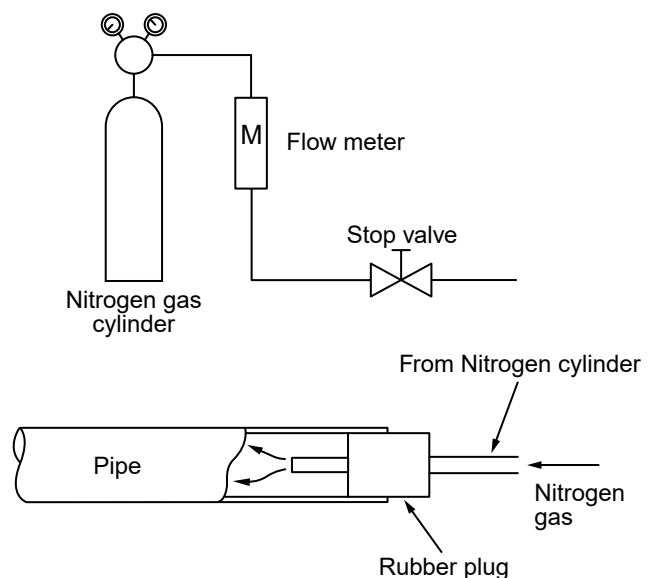
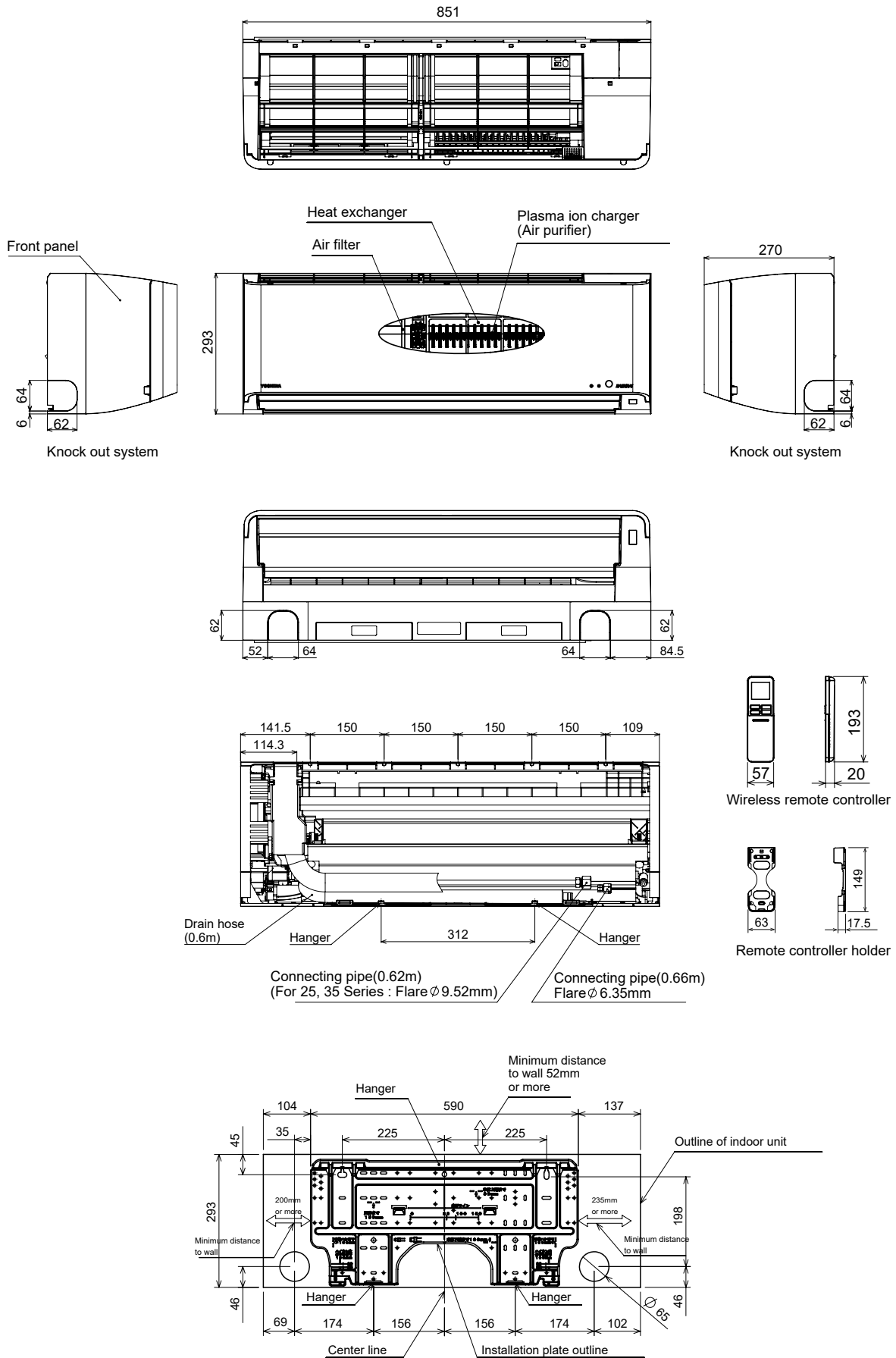

Fig. 3-5-1 Prevention of oxidation during brazing

4. CONSTRUCTION VIEWS

4-1. Indoor Unit



4-2. Outdoor Unit

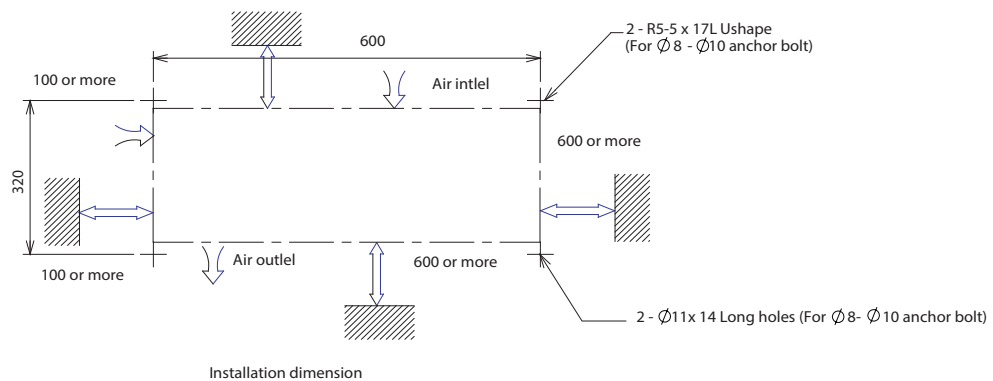
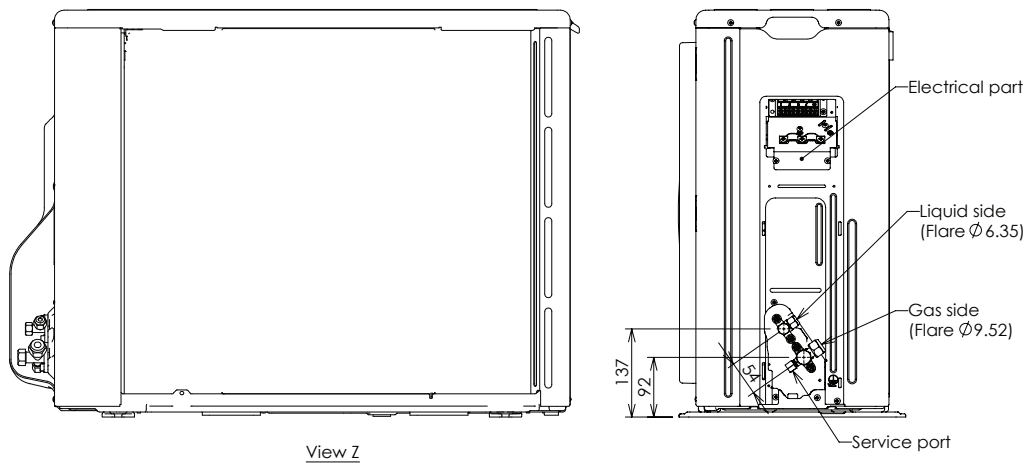
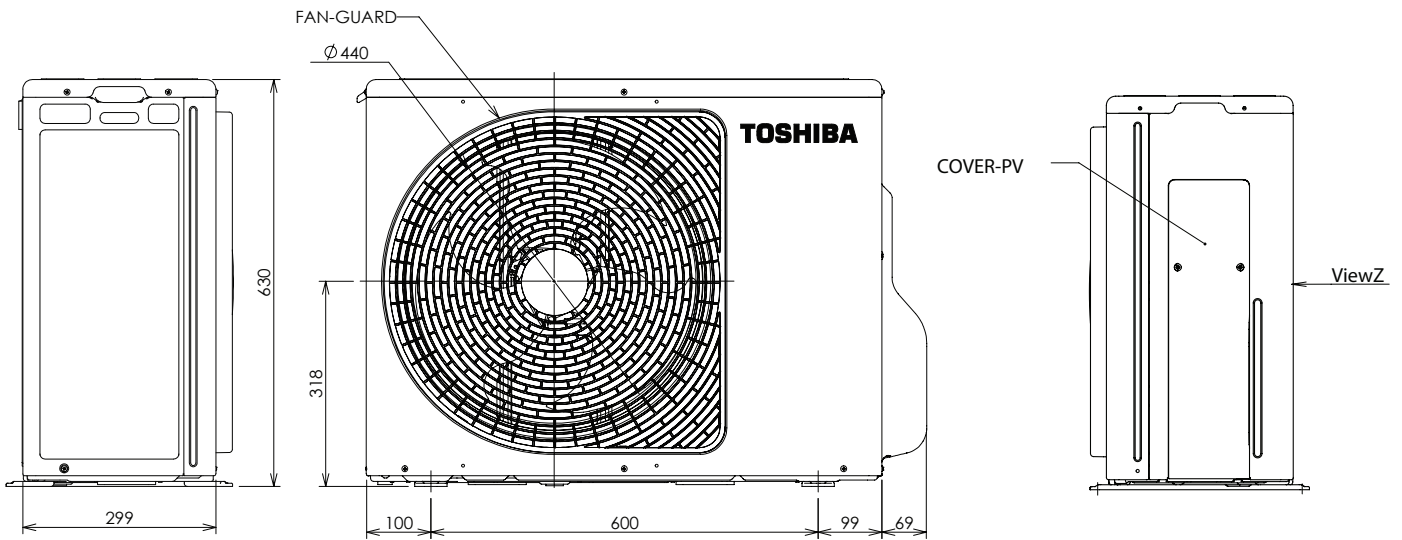
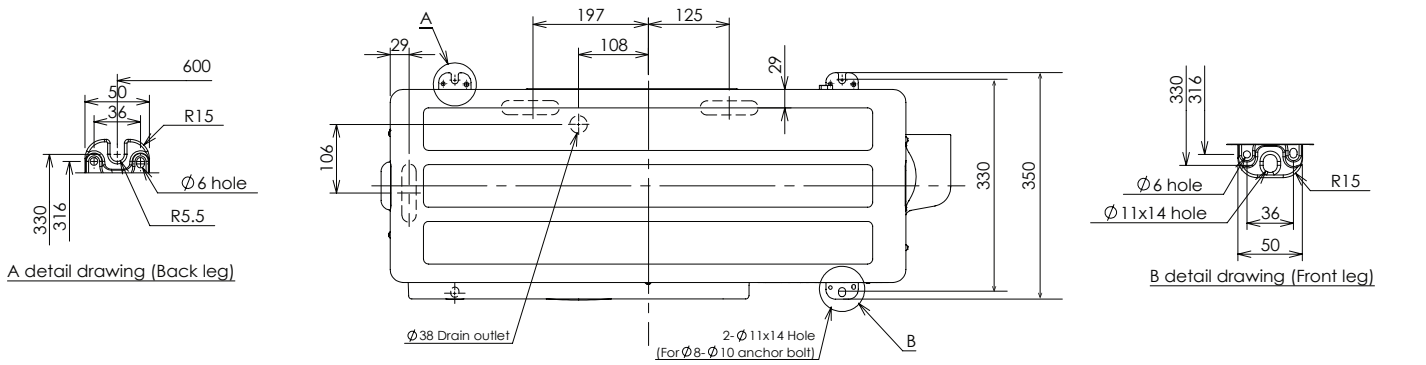

5. WIRING DIAGRAM

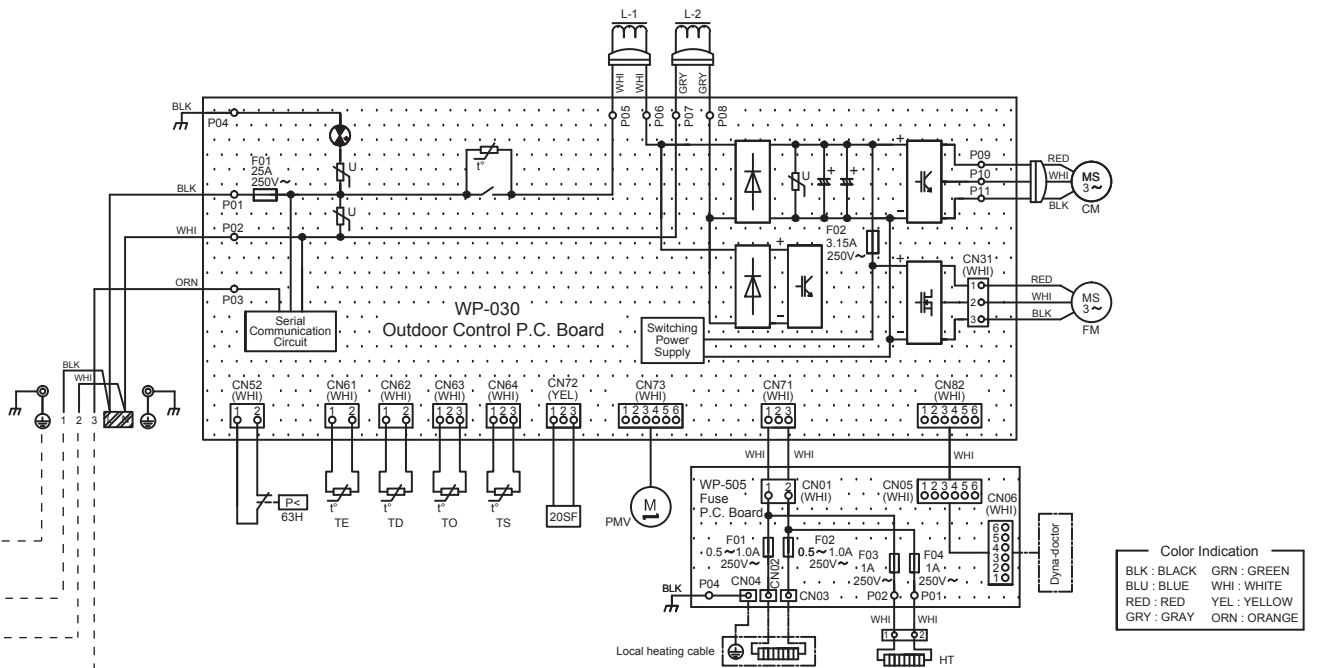
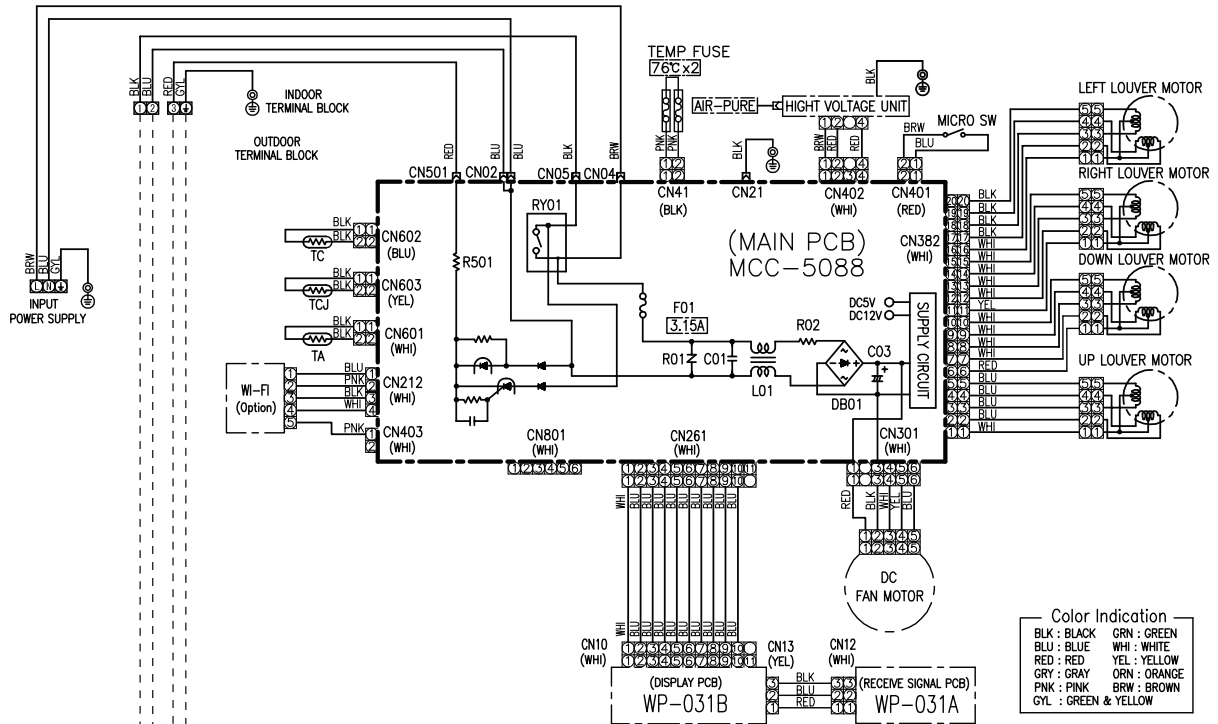

6. SPECIFICATIONS OF ELECTRICAL PARTS

6-1. Indoor Unit

| No. | Parts name | Type | Specifications |
|-----|--|------------|-----------------|
| 1 | Fan motor (for indoor) | FJM-340-40 | DC280-340V, 42W |
| 2 | Room temp. sensor (TA-sensor) | (-) | 10kΩ at 25°C |
| 3 | Heat exchanger temp. sensor (TC-sensor) | (-) | 10kΩ at 25°C |
| 4 | Heat exchanger temp. sensor (TCJ-sensor) | (-) | 10kΩ at 25°C |
| 5 | Louver motor | MP24Z4N | 16 poles, DC12V |

6-2. Outdoor Unit

| No. | Parts name | Model name | Rating | |
|-----|---|---------------------|-------------------------|------------------------|
| 1 | Reactor | CH-57-Z-T | L = 8.88 ~ 10.01mH, 16A | |
| 2 | Outdoor fan motor | ICF-340-A70-1 | DC140-340V, 70W | |
| 3 | Suction temp. sensor (TS sensor) | (Inverter attached) | 10kΩ (25°C) | |
| 4 | Discharge temp. sensor (TD sensor) | (Inverter attached) | 62kΩ (20°C) | |
| 5 | Outside air temp. sensor (TO sensor) | (Inverter attached) | 10kΩ (25°C) | |
| 6 | Heat exchanger temp. sensor (TE sensor) | (Inverter attached) | 10kΩ (25°C) | |
| 7 | Terminal block (6P) | JX0-6B | 30A, AC600V | |
| 8 | Compressor | RAS-25N4AVPG-ND | KTN150D63UFZ3 | 3-phases 6-poles 900W |
| | | RAS-35N4AVPG-ND | KTM180D68UFZ | 3-phases 6-poles 1050W |
| 9 | Coil for PMV | PQ-M10012-000313 | DC12V | |
| 10 | Coil for 4-way valve | STF-H01AJ1872A1 | AC Type | |
| 11 | Heater cord | CSC-2 100W | 100W | |

7. REFRIGERANT CYCLE DIAGRAM

7-1. Refrigerant Cycle Diagram

RAS-25N4KVPG-ND / RAS-25N4AVPG-ND

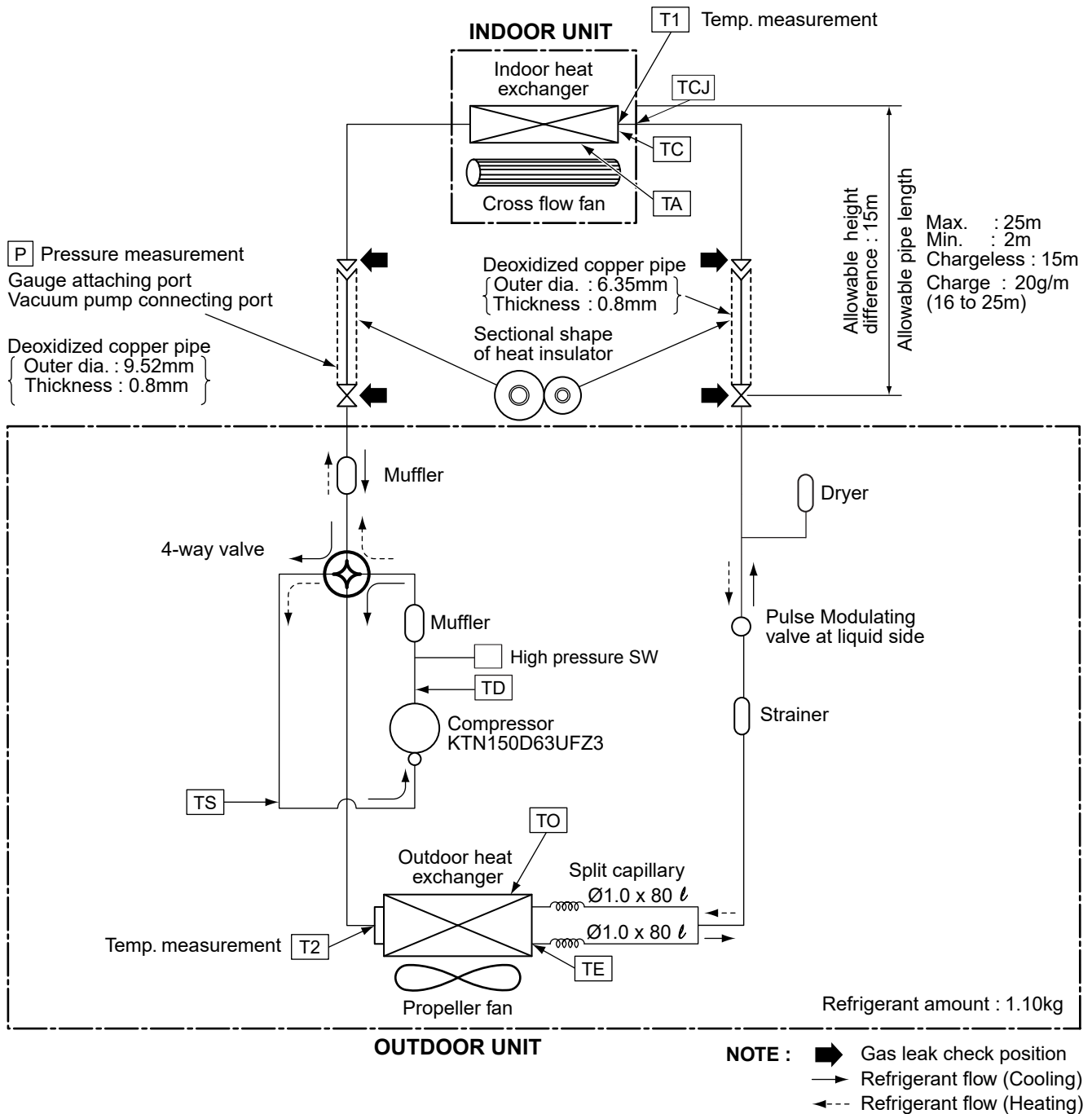

NOTE :

- The maximum pipe length of this air conditioner is 25 m. When the pipe length exceeds 15m, the additional charging of refrigerant, 20g per 1m for the part of pipe exceeded 15m is required. (Max. 200g)

RAS-35N4KVPG-ND / RAS-35N4AVPG-ND

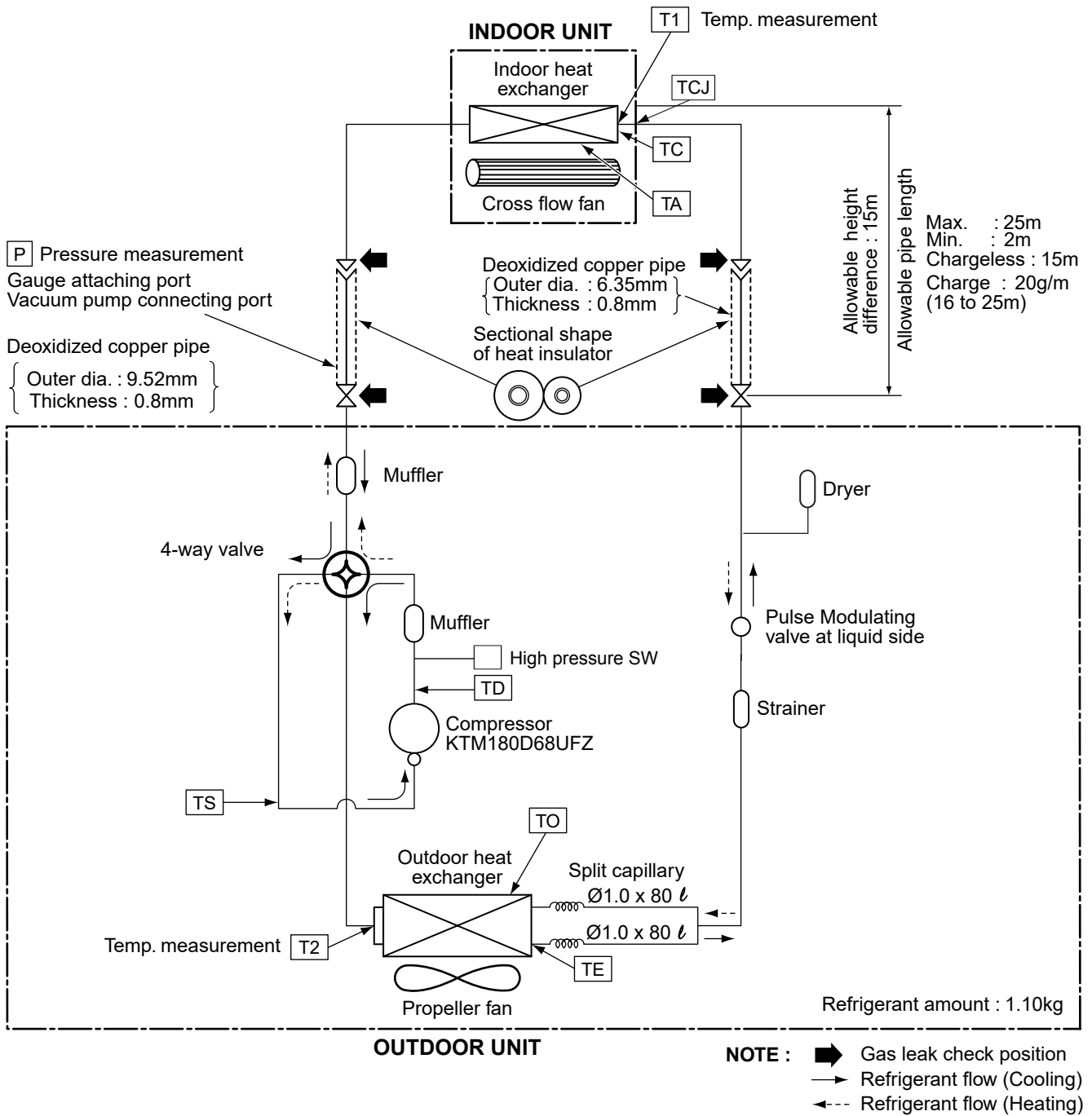

NOTE :

- The maximum pipe length of this air conditioner is 25 m. When the pipe length exceeds 15m, the additional charging of refrigerant, 20g per 1m for the part of pipe exceeded 15m is required. (Max. 200g)

7-2. Operation Data

<Cooling>

| Temperature condition(°C) | | Model name | Standard pressure P (MPa) | Heat exchanger pipe temp. | | Indoor fan mode | Outdoor fan mode | Compressor revolution (rps) | Connecting piping (m) |
|---------------------------|---------|-----------------|------------------------------|---------------------------|----------|-----------------|------------------|-----------------------------|-----------------------|
| Indoor | Outdoor | | | T1 (°C) | T2 (°C) | | | | |
| 27/19 | 35/- | RAS-25N4KVPG-ND | 1.1 to 1.2 | 14 to 16 | 39 to 41 | High | High | 23 | 5 |
| | | RAS-35N4KVPG-ND | 0.9 to 1.1 | 12 to 14 | 41 to 43 | High | High | 31 | |

<Heating>

| Temperature condition(°C) | | Model name | Standard pressure P (MPa) | Heat exchanger pipe temp. | | Indoor fan mode | Outdoor fan mode | Compressor revolution (rps) | Connecting piping (m) |
|---------------------------|---------|-----------------|------------------------------|---------------------------|---------|-----------------|------------------|-----------------------------|-----------------------|
| Indoor | Outdoor | | | T1 (°C) | T2 (°C) | | | | |
| 20/- | 7/6 | RAS-25N4KVPG-ND | 2.1 to 2.3 | 33 to 35 | 3 to 4 | High | High | 33 | 5 |
| | | RAS-35N4KVPG-ND | 2.4 to 2.6 | 36 to 38 | 2 to 3 | High | High | 35 | |

NOTES : Measure surface temperature of heat exchanger pipe around center of heat exchanger path U bent.
(Thermistor thermometer)

8. CONTROL BLOCK DIAGRAM

8-1. Indoor Unit

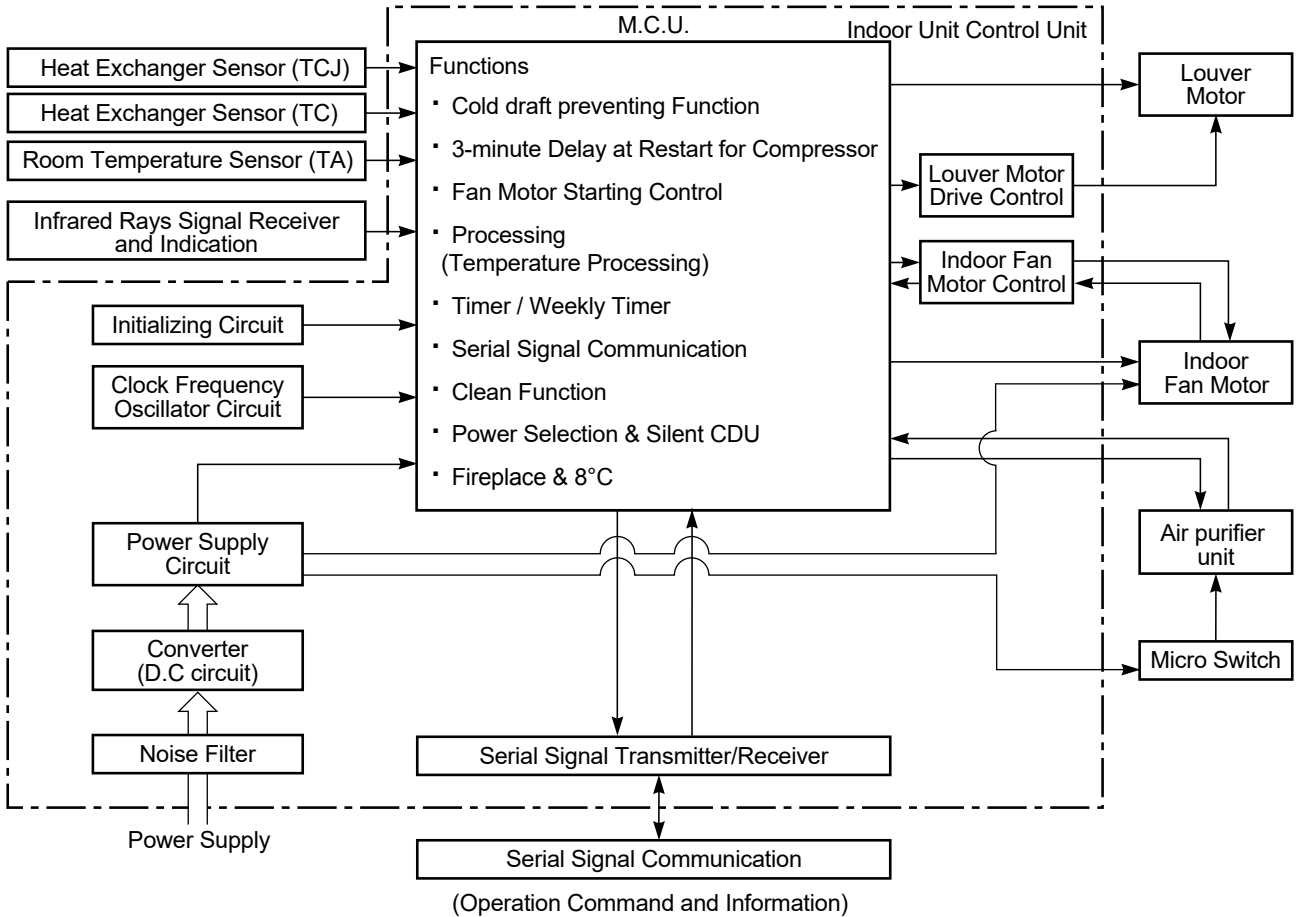

REMOTE CONTROLLER

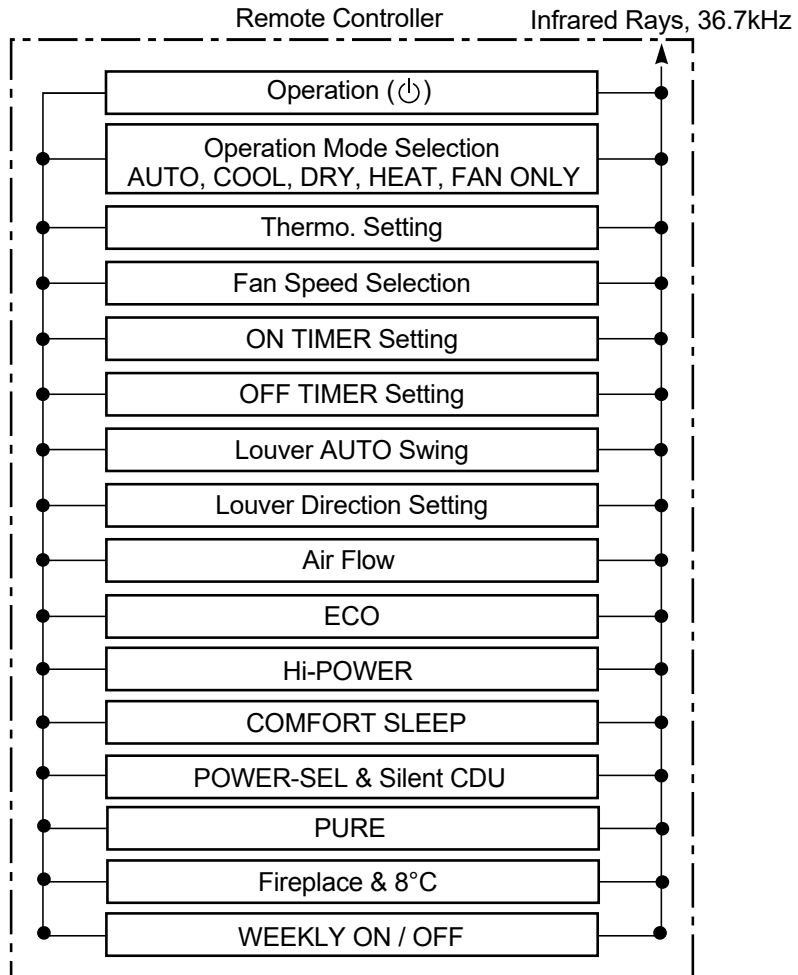

8-2. Outdoor Unit (Inverter Assembly)

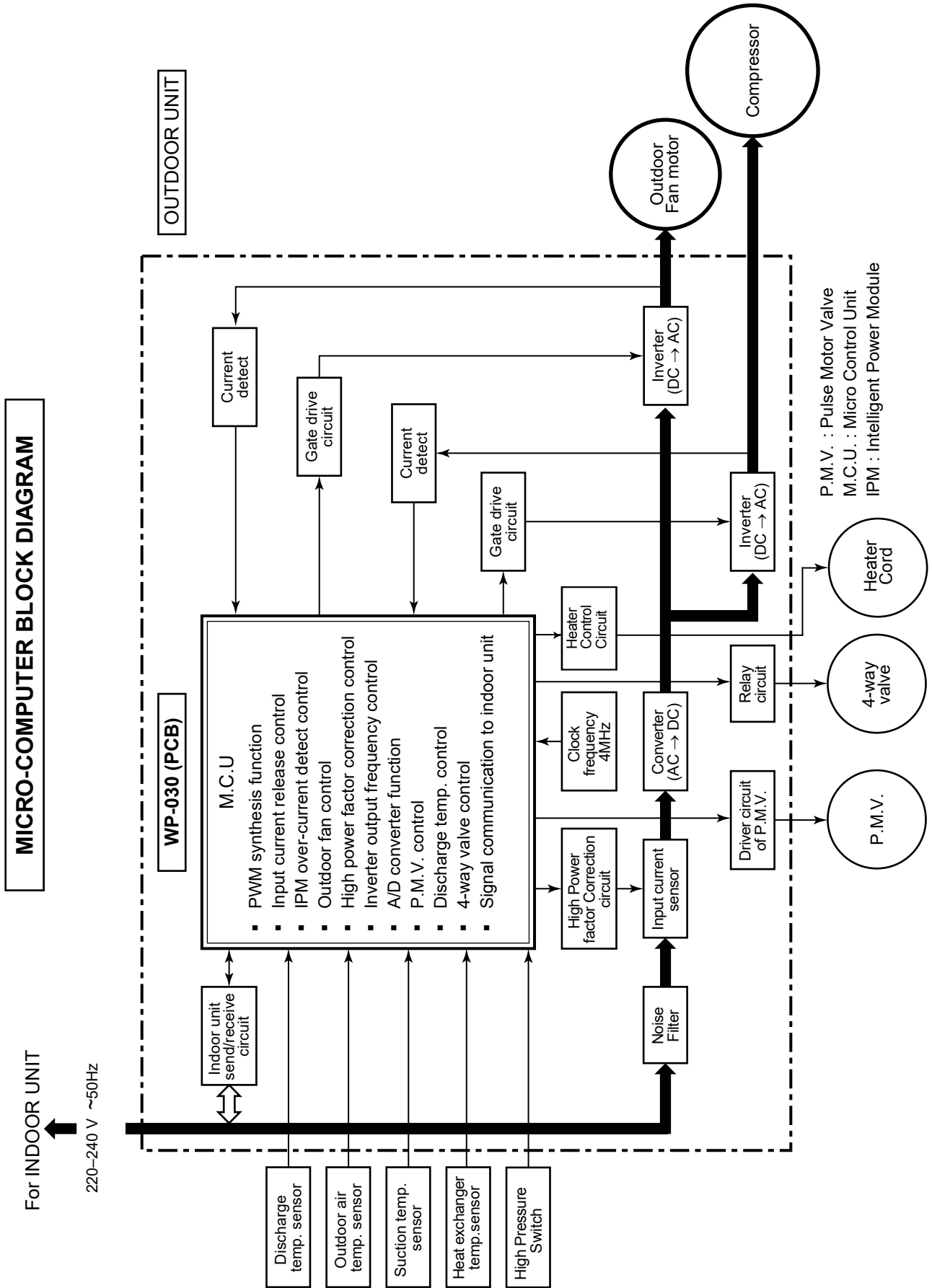

9. OPERATION DESCRIPTION

9-1. Outline of Air Conditioner Control

This air conditioner is a capacity-variable type air conditioner. Its system can control the speed of compressor motor according to load. The drive circuit for the indoor motor is mounted in the indoor unit. The drive circuits for outdoor motor and compressor are mounted in the outdoor unit.

The entire air conditioner is mainly controlled by the indoor unit controller. The indoor unit controller drives the indoor fan motor based upon command sent from the remote controller. Moreover, it also determines required speed of compressor motor and then transfers the operation command to the outdoor unit controller.

The outdoor unit controller receives operation command from the indoor unit and controls revolution speed of the compressor motor.

The outdoor unit controller controls speed of compressor motor by controlling output voltage of the inverter and switching timing of supply power (current transfer timing), so that compressor motor operates according to the operation command. And then, the outdoor unit controller transfers the operating status back to the indoor unit controller.

As the compressor adopts six-poles brush less DC motor, the frequency of the supply power from inverter to compressor is three-times cycles of the actual number of revolution.

1. Role of indoor unit controller

The indoor unit controller judges the operation commands from the remote controller and assumes the following functions.

- Judgment of suction air temperature of the indoor heat exchanger by using the indoor temp. sensor. (TA sensor)
- Judgment of the indoor heat exchanger temperature by using heat exchanger sensor (TC sensor) (Prevent-freezing control, etc.)
- Louver motor control
- Indoor fan motor operation control
- LED (Light Emitting Diode) display control
- Transferring of operation command signal (Serial signal) to the outdoor unit
- Reception of information of operation status (Serial signal including outside temp. data) from the outdoor unit and judgment/display of error

2. Role of outdoor unit controller

Receiving the operation command signal (Serial signal) from the indoor unit controller, the outdoor unit performs compressor operation control as followed to judgment of serial signal from indoor side.

- Detection of inverter input current and current release operation
- Over-current detection and prevention operation to IGBT module (Compressor stop function)
- Compressor and outdoor fan stop function when serial signal is off (when the serial signal does not reach the board assembly of outdoor control by trouble of the signal system)
- Transferring of operation information (Serial signal) from outdoor unit controller to indoor unit controller
- Detection of outdoor temperature and operation revolution control
- Defrost control in heating operation (Temp. measurement by outdoor heat exchanger and control for 4-way valve and outdoor fan)

3. Contents of operation command signal (Serial signal) from indoor unit controller to outdoor unit controller

The following three types of signals are sent from the indoor unit controller.

- Operation mode set on the remote controller
- Compressor revolution command signal defined by indoor temperature and set temperature (Correction along with variation of room temperature and correction of indoor heat exchanger temperature are added.)
- Temperature of indoor heat exchanger
- For these signals ([Operation mode] and [Compressor revolution] indoor heat exchanger temperature), the outdoor unit controller monitors the input current to the inverter, and performs the followed operation within the range that current does not exceed the allowable value.

4. Contents of operation command signal (Serial signal) from outdoor unit controller to indoor unit controller

The following signals are sent from the outdoor unit controller.

- The current operation mode
 - The current compressor revolution
 - Outdoor temperature
 - Existence of protective circuit operation
- For transferring of these signals, the indoor unit controller monitors the contents of signals, and judges existence of trouble occurrence. Contents of judgment are described below.
- Whether distinction of the current operation status meets to the operation command signal
 - Whether protective circuit operates
- When no signal is received from the outdoor unit controller, it is assumed as a trouble.

9-2. Operation Description

| | |
|---|----|
| 1. Basic operation | 27 |
| 1. Operation control | 27 |
| 2. Cooling/Heating operation | 28 |
| 3. AUTO operation | 28 |
| 4. DRY operation | 28 |
| 2. Indoor fan motor control | 29 |
| 3. Outdoor fan motor control | 31 |
| 4. Capacity control | 32 |
| 5. Current release control | 32 |
| 6. Release protective control by temperature of indoor heat exchanger | 33 |
| 7. Defrost control (Only in heating operation) | 34 |
| 8. Louver control | 36 |
| 1) Louver position | 36 |
| 2) Wind direction adjustment | 38 |
| 3) Swing | 38 |
| 9. ECO operation | 39 |
| 10. Temporary operation | 40 |
| 11. Plasma ionizer purifier control | 40 |
| 12. Discharge temperature control | 41 |
| 13. High pressure control | 42 |
| 14. Pulse Modulating valve (P.M.V.) control | 42 |
| 15. Self-Cleaning function | 43 |
| 16. Remote-A or B selection | 45 |
| 17. QUIET mode | 45 |
| 18. COMFORT SLEEP mode | 45 |
| 19. Short Timer | 46 |
| 20. Hi-POWER Mode | 46 |
| 21. POWER Selection Mode | 47 |
| 22. Silent Operation | 47 |
| 23. Outdoor Quiet Control | 48 |
| 24. Operation mode selectable | 48 |
| 25. Fireplace Operation | 49 |
| 26. 8 degree heating / Frost protective Operation | 49 |
| 27. Cord Heater Control | 49 |
| 28. FCU Display lamp brightness control | 50 |

9-3. Auto Restart Function

| | |
|--|----|
| 9-3-1. How to Set the Auto Restart Function | 51 |
| 9-3-2. How to Cancel the Auto Restart Function | 52 |
| 9-3-3. Power Failure During Timer Operation | 52 |

9-4. Remote Controller and Its Functions

| | |
|---|----|
| 9-4-1. Parts Name of Remote Controller | 53 |
| 9-4-2. Operation of remote control | 53 |
| 9-4-3. Name and Functions of Indications on Remote Controller | 62 |

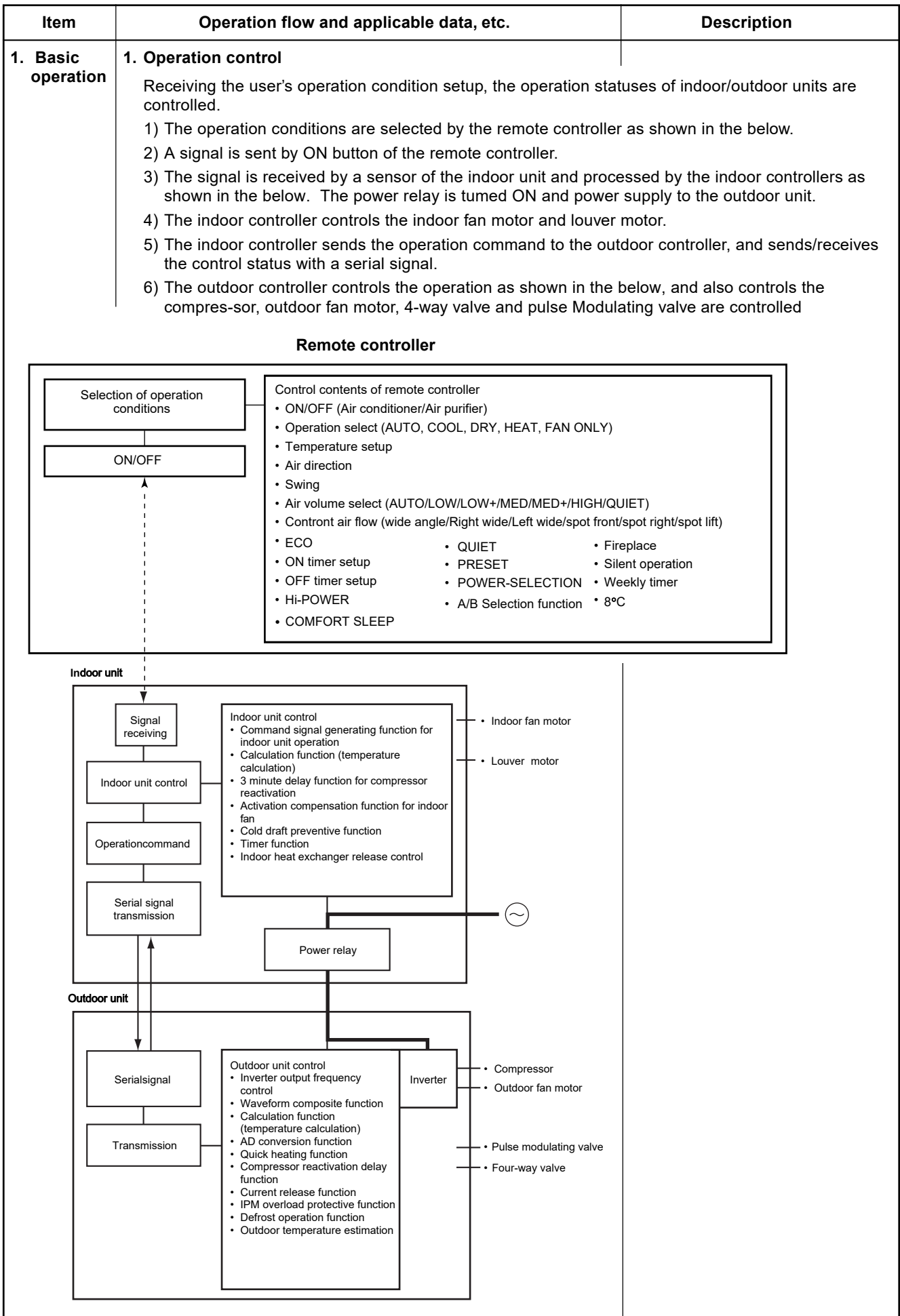

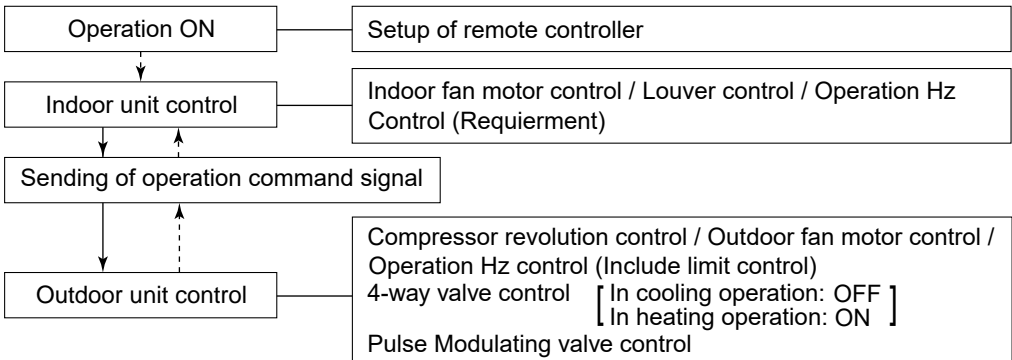
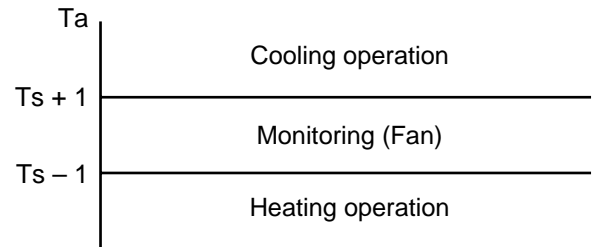
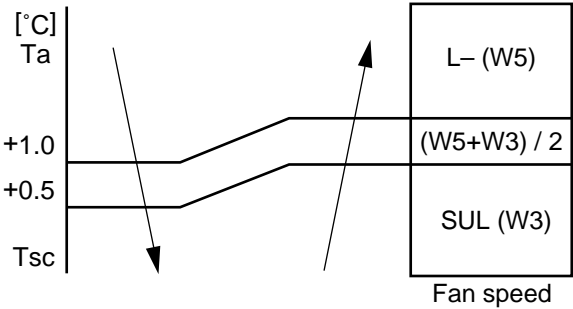
| Item | Operation flow and applicable data, etc. | Description |
|----------------------------------|--|--|
| <p>1. Basic operation</p> | <p>2. Cooling/Heating operation</p> <p>The operations are performed in the following parts by controls according to cooling/heating conditions.</p> <ol style="list-style-type: none"> 1) Receiving the operation ON signal of the remote controller, the cooling or heating operation signal starts being transferred from the indoor controller to the outdoor unit. 2) At the indoor unit side, the indoor fan is operated according to the contents of “2. Indoor fan motor control” and the louver according to the contents of “8. Louver control”, respectively. 3) The outdoor unit controls the outdoor fan motor, compressor, pulse Modulating valve and 4-way valve according to the operation signal sent from the indoor unit.  | |
| | <p>3. AUTO operation</p> <p>Selection of operation mode As shown in the following figure, the operation starts by selecting automatically the status of room temperature (Ta) when starting AUTO operation.</p> <p>*1. When reselecting the operation mode, the fan speed is controlled by the previous operation mode.</p>  | <ol style="list-style-type: none"> 1) Detects the room temperature (Ta) when the operation started. 2) Selects an operation mode from Ta in the left figure. 3) Fan operation continues until an operation mode is selected. 4) When AUTO operation has started within 2 hours after heating operation stopped and if the room temperature is 20°C or more, the fan operation is performed with "Super Ultra LOW" mode for 3 minutes. Then, select an operation mode. 5) If the status of compressor-OFF continues for 15 minutes the room temperature after selecting an operation mode (COOL/HEAT), reselect an operation mode. |
| | <p>4. DRY operation</p> <p>DRY operation is performed according to the difference between room temperature and the setup temperature as shown below.</p> <p>In DRY operation, fan speed is controlled in order to prevent lowering of the room temperature and to avoid air flow from blowing directly to persons.</p>  | <ol style="list-style-type: none"> 1) Detects the room temperature (Ta) when the DRY operation started. 2) Starts operation under conditions in the left figure according to the temperature difference between the room temperature and the setup temperature (Tsc). Setup temperature (Tsc) = Set temperature on remote controller (Ts) + (0.0 to 1.0) 3) When the room temperature is lower 1°C or less than the setup temperature, turn off the compressor. |

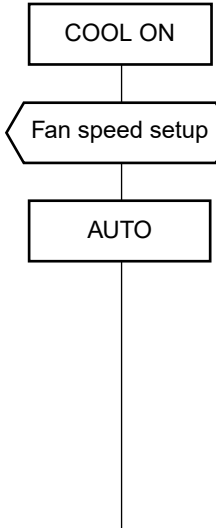
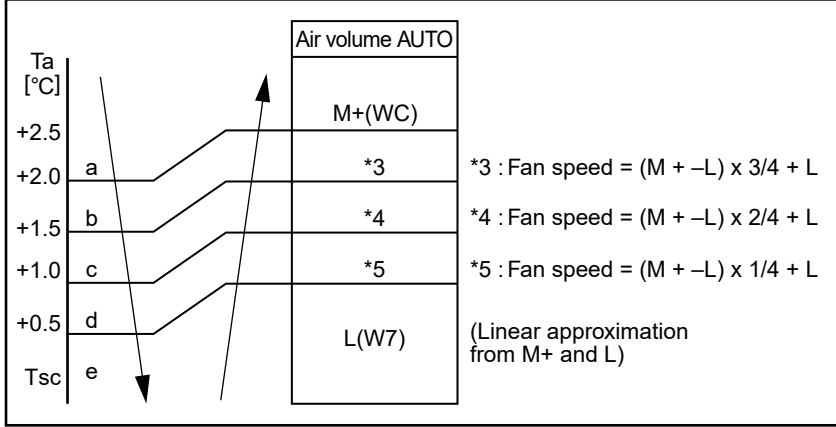
| Item | Operation flow and applicable data, etc. | Description | | | | | | | | | | | | | | |
|---|--|-------------|-----------|----------------------|-----------------|----------------------|-----------------|----------------------|-----------------|----------------------|-------------|---|----|-------|----|--|
| <p>2. Indoor fan motor control</p>  | <p><In cooling operation> (This operation controls the fan speed at indoor unit side.) The indoor fan (cross flow fan) is operated by the phase-control induction motor. The fan rotates in 5 stages in MANUAL mode, and in 5 stages in AUTO mode, respectively. (Table 1)</p> <p>(Fig. 1)</p> <table border="1" data-bbox="475 645 1007 936"> <thead> <tr> <th>Indication</th> <th>Fan speed</th> </tr> </thead> <tbody> <tr> <td>L </td> <td>W7</td> </tr> <tr> <td>L+ </td> <td>(L + M) / 2</td> </tr> <tr> <td>M </td> <td>WA</td> </tr> <tr> <td>M+ </td> <td>(M + H) / 2</td> </tr> <tr> <td>H </td> <td>WD</td> </tr> <tr> <td>Quiet </td> <td>W5</td> </tr> </tbody> </table> <p>(Fig. 2)</p>  | Indication | Fan speed | L | W7 | L+ | (L + M) / 2 | M | WA | M+ | (M + H) / 2 | H | WD | Quiet | W5 | <p>* Symbols</p> <p>UH : Ultra High H : High M+ : Medium+ M : Medium L+ : Low+ L : Low L- : Low- UL : Ultra Low SUL : Super Ultra Low</p> <p>* The values of fan speed and air flow volume indicate on the table are measured when the louver is inclined downward. Fan speed and air flow volume broadly vary with position of louver.</p> <p>1) When setting the fan speed to L, L+, M, M+,H or Quiet on the remote controller, the operation is performed with the constant speed shown in Fig. 1.</p> <p>2) When setting the fan speed to AUTO on the remote controller, revolution of the fan motor is controlled to the fan speed level shown in Fig. 2 and Table 1 according to the setup temperature, room temperature, and heat exchanger temperature.</p> |
| Indication | Fan speed | | | | | | | | | | | | | | | |
| L | W7 | | | | | | | | | | | | | | | |
| L+ | (L + M) / 2 | | | | | | | | | | | | | | | |
| M | WA | | | | | | | | | | | | | | | |
| M+ | (M + H) / 2 | | | | | | | | | | | | | | | |
| H | WD | | | | | | | | | | | | | | | |
| Quiet | W5 | | | | | | | | | | | | | | | |
| <p>(Table 1) Indoor fan air flow rate</p> | | | | | | | | | | | | | | | | |
| Fan speed level | Mode | | | RAS-25N4KVPG-ND | | | | RAS-35N4KVPG-ND | | | | | | | | |
| | Cool | Heat | Dry | Cooling | | Heating | | Cooling | | Heating | | | | | | |
| Fan speed (rpm) | | | | Air flow rate (m3/h) | Fan speed (rpm) | Air flow rate (m3/h) | Fan speed (rpm) | Air flow rate (m3/h) | Fan speed (rpm) | Air flow rate (m3/h) | | | | | | |
| WF | UH | UH | UH | 1100 | 690 | 1140 | 731 | 1150 | 742 | 1160 | 750 | | | | | |
| WE | UH | H | | 1100 | 690 | 1140 | 731 | 1150 | 742 | 1160 | 750 | | | | | |
| WD | H | M+ | UH | 1080 | 676 | 990 | 611 | 1100 | 698 | 1020 | 648 | | | | | |
| WC | M+ | M | H | 930 | 551 | 990 | 611 | 1000 | 628 | 990 | 611 | | | | | |
| WB | M | M | M+ | 930 | 551 | 840 | 475 | 930 | 551 | 840 | 475 | | | | | |
| WA | M | M | M | 780 | 423 | 840 | 475 | 780 | 423 | 840 | 475 | | | | | |
| W9 | M | L+ | M | 780 | 423 | 750 | 401 | 780 | 423 | 750 | 401 | | | | | |
| W8 | L+ | L | L+ | 710 | 368 | 660 | 322 | 710 | 368 | 660 | 322 | | | | | |
| W7 | L | L- | L+ | 640 | 305 | 600 | 274 | 640 | 305 | 600 | 274 | | | | | |
| W6 | L- | L- | L | 560 | 243 | 600 | 274 | 560 | 243 | 600 | 274 | | | | | |
| W5 | UL | UL | L- | 510 | 194 | 550 | 235 | 510 | 194 | 550 | 235 | | | | | |
| W4 | UL | UL | UL | 500 | 187 | 550 | 235 | 500 | 187 | 550 | 235 | | | | | |
| W3 | SUL | SUL | SUL/SL- | 500 | 187 | 540 | 224 | 500 | 187 | 540 | 224 | | | | | |
| W2 | SUL | SUL | SUL/SL- | 480 | 173 | 520 | 204 | 480 | 173 | 520 | 204 | | | | | |
| W1 | SUL | SUL | SUL/SL- | 440 | 142 | 440 | 142 | 440 | 142 | 440 | 142 | | | | | |

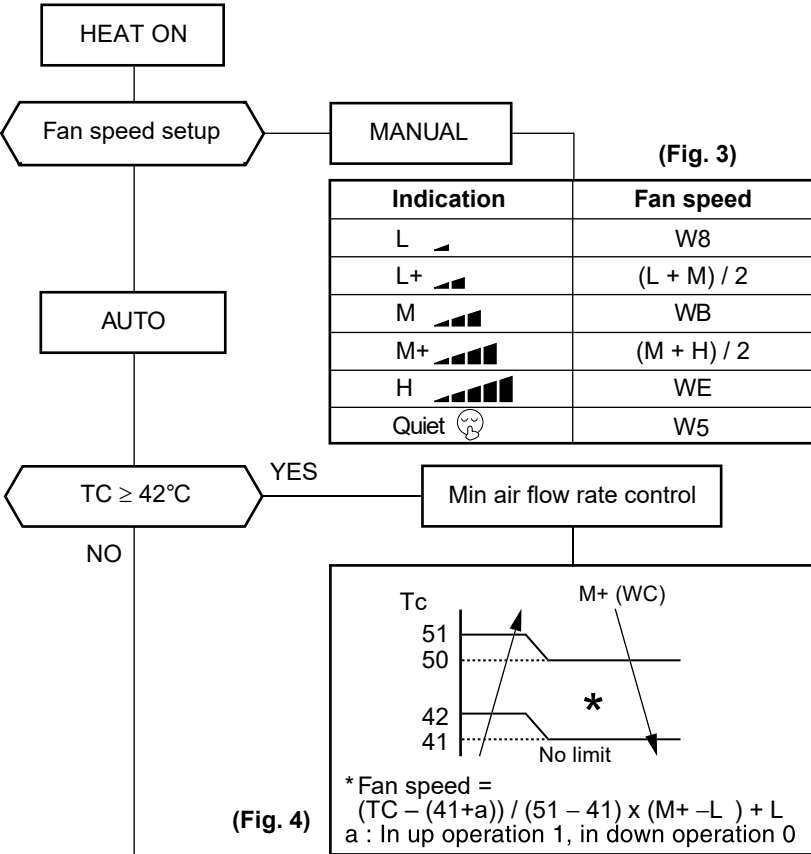
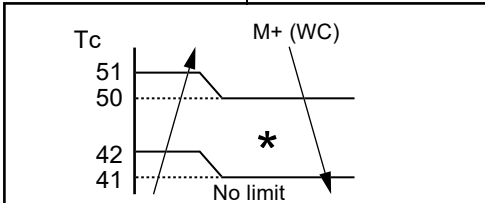
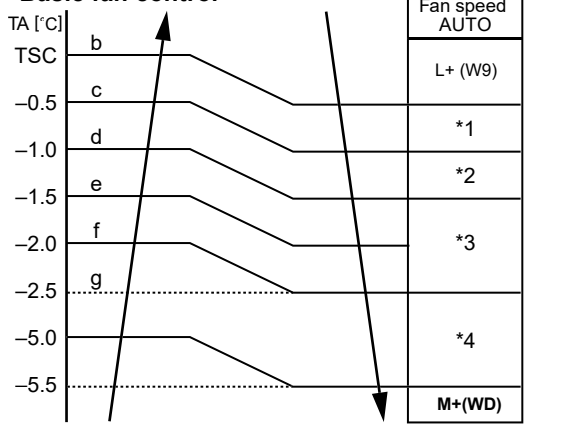
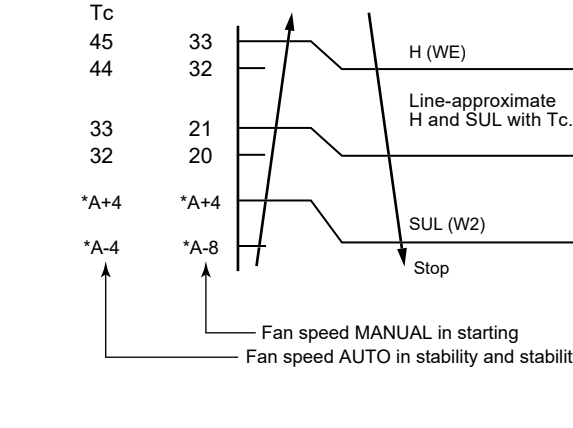
| Item | Operation flow and applicable data, etc. | Description | | | | | | | | | | | | | | |
|---|--|---|--------------|----------|--|---|------------|--|---|-------------|----|----|--------|----|---|---|
| <p>2. Indoor fan motor control</p>  <p>(Fig. 3)</p> <table border="1" data-bbox="494 481 981 750"> <thead> <tr> <th>Indication</th> <th>Fan speed</th> </tr> </thead> <tbody> <tr> <td>L </td> <td>W8</td> </tr> <tr> <td>L+ </td> <td>(L + M) / 2</td> </tr> <tr> <td>M </td> <td>WB</td> </tr> <tr> <td>M+ </td> <td>(M + H) / 2</td> </tr> <tr> <td>H </td> <td>WE</td> </tr> <tr> <td>Quiet </td> <td>W5</td> </tr> </tbody> </table> <p>(Fig. 4)</p>  <p>* Fan speed = $(TC - (41+a)) / (51 - 41) \times (M+ - L) + L$ a : In up operation 1, in down operation 0</p> | Indication | Fan speed | L | W8 | L+ | (L + M) / 2 | M | WB | M+ | (M + H) / 2 | H | WE | Quiet | W5 | <p><In heating operation></p> <ol style="list-style-type: none"> 1) When setting the fan speed to L, L+, M, M+, H or Quiet on the remote controller, the operation is performed with the constant speed shown in Fig. 3 and Table 1. 2) When setting the fan speed to AUTO on the remote controller, revolution of the fan motor is controlled to the fan speed level shown in Fig. 5 according to the set temperature and room temperature. 3) Min air flow rate is controlled by temperature of the indoor heat exchanger (Tc) as shown in Fig. 4. 4) Cold draft prevention, the fan speed is controlled by temperature of the indoor heat exchanger (Tc) as shown in Fig. 6. 5) In order to prevent Cold draft when compressor step during heating operation. Then louver will move to upper position and fan speed will reduce or off. <p>Cold draft preventive control</p> | <ol style="list-style-type: none"> 1) When setting the fan speed to L, L+, M, M+, H or Quiet on the remote controller, the operation is performed with the constant speed shown in Fig. 3 and Table 1. 2) When setting the fan speed to AUTO on the remote controller, revolution of the fan motor is controlled to the fan speed level shown in Fig. 5 according to the set temperature and room temperature. 3) Min air flow rate is controlled by temperature of the indoor heat exchanger (Tc) as shown in Fig. 4. 4) Cold draft prevention, the fan speed is controlled by temperature of the indoor heat exchanger (Tc) as shown in Fig. 6. 5) In order to prevent Cold draft when compressor step during heating operation. Then louver will move to upper position and fan speed will reduce or off. |
| Indication | Fan speed | | | | | | | | | | | | | | | |
| L | W8 | | | | | | | | | | | | | | | |
| L+ | (L + M) / 2 | | | | | | | | | | | | | | | |
| M | WB | | | | | | | | | | | | | | | |
| M+ | (M + H) / 2 | | | | | | | | | | | | | | | |
| H | WE | | | | | | | | | | | | | | | |
| Quiet | W5 | | | | | | | | | | | | | | | |
| <p>Basic fan control</p>  <table border="1" data-bbox="590 1209 710 1646"> <thead> <tr> <th>Fan speed</th> <th>AUTO</th> </tr> </thead> <tbody> <tr> <td>L+(W9)</td> <td></td> </tr> <tr> <td>*1</td> <td></td> </tr> <tr> <td>*2</td> <td></td> </tr> <tr> <td>*3</td> <td></td> </tr> <tr> <td>*4</td> <td></td> </tr> <tr> <td>M+(WD)</td> <td></td> </tr> </tbody> </table> <p>*1: Fan speed = $(M + -L+) \times 1 \div 5 + L+$ *2: Fan speed = $(M + -L+) \times 2 \div 5 + L+$ *3: Fan speed = $(M + -L+) \times 3 \div 5 + L+$ *4: Fan speed = $(M + -L+) \times 4 \div 5 + L+$ (Calculated with linear approximation from M+ and L+)</p> <p>(Fig. 5)</p> | Fan speed | AUTO | L+(W9) | | *1 | | *2 | | *3 | | *4 | | M+(WD) | |  <p>* No limitation while fan speed MANUAL mode is in stability. *A: When Tsc ≥ 24, A is 24, and when Tsc < 24, A is Tsc Tsc: Set value</p> <p>(Fig. 6)</p> | |
| Fan speed | AUTO | | | | | | | | | | | | | | | |
| L+(W9) | | | | | | | | | | | | | | | | |
| *1 | | | | | | | | | | | | | | | | |
| *2 | | | | | | | | | | | | | | | | |
| *3 | | | | | | | | | | | | | | | | |
| *4 | | | | | | | | | | | | | | | | |
| M+(WD) | | | | | | | | | | | | | | | | |
| <p>[[In starting and in stability]]</p> | | | | | | | | | | | | | | | | |
| <table border="1"> <thead> <tr> <th></th> <th>In starting</th> <th>In stability</th> </tr> </thead> <tbody> <tr> <td>FAN AUTO</td> <td> <ul style="list-style-type: none"> • Until 12 minutes passed after operation start • When 12 to 25 minutes passed after operation start and room temperature is 3°C or lower than set temperature. </td> <td> <ul style="list-style-type: none"> • When 12 to 25 minutes passed after operation start and room temperature is higher than (set temperature -3°C) • When 25 minutes or more passed after operation start </td> </tr> <tr> <td>FAN Manual</td> <td> <ul style="list-style-type: none"> • Room temperature < Set temperature -4°C </td> <td> <ul style="list-style-type: none"> • Room temperature ≥ Set temperature -3.5°C </td> </tr> </tbody> </table> | | In starting | In stability | FAN AUTO | <ul style="list-style-type: none"> • Until 12 minutes passed after operation start • When 12 to 25 minutes passed after operation start and room temperature is 3°C or lower than set temperature. | <ul style="list-style-type: none"> • When 12 to 25 minutes passed after operation start and room temperature is higher than (set temperature -3°C) • When 25 minutes or more passed after operation start | FAN Manual | <ul style="list-style-type: none"> • Room temperature < Set temperature -4°C | <ul style="list-style-type: none"> • Room temperature ≥ Set temperature -3.5°C | | | | | | | |
| | In starting | In stability | | | | | | | | | | | | | | |
| FAN AUTO | <ul style="list-style-type: none"> • Until 12 minutes passed after operation start • When 12 to 25 minutes passed after operation start and room temperature is 3°C or lower than set temperature. | <ul style="list-style-type: none"> • When 12 to 25 minutes passed after operation start and room temperature is higher than (set temperature -3°C) • When 25 minutes or more passed after operation start | | | | | | | | | | | | | | |
| FAN Manual | <ul style="list-style-type: none"> • Room temperature < Set temperature -4°C | <ul style="list-style-type: none"> • Room temperature ≥ Set temperature -3.5°C | | | | | | | | | | | | | | |

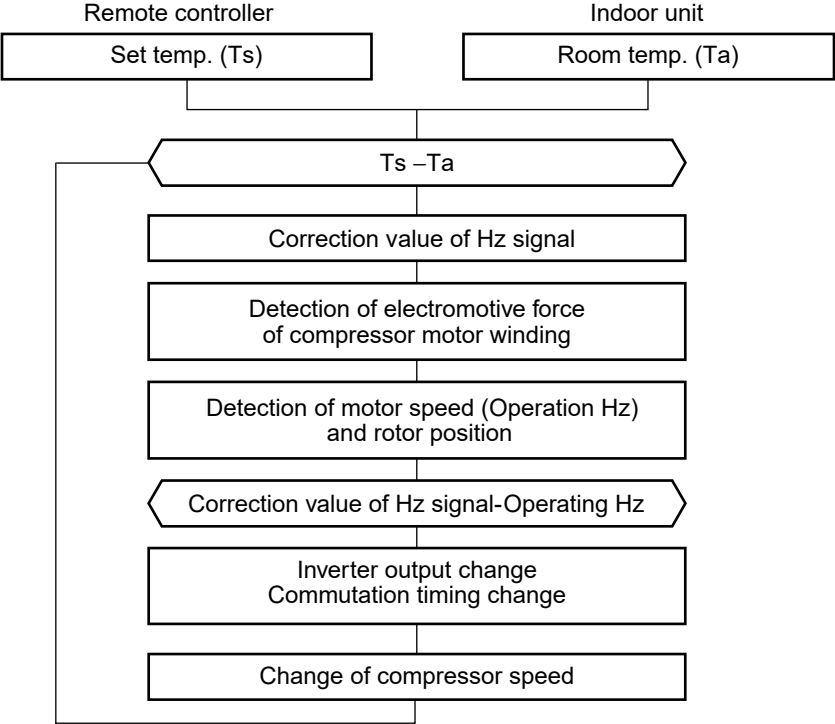
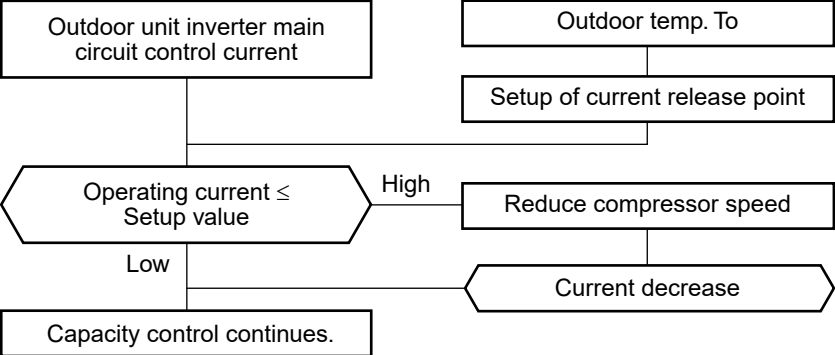

| Item | Operation flow and applicable data, etc. | Description | | | | | | | | | | | | | | | | | | | | | | | | | | | | | | | | | | | | | | | | | | | | | | | | | | | | | | | | | | | | | | | | | | | | | | | | | | | | | | | | | | | | | | | | | | | | | | | | | | | | | | | | | | | | | | | | | | | | | | | | | | | | | | | | | | | | | | | | | | | | | | | | | | | | | | |
|---|--|--|-----|------------------|-----|-----------|-----|-----|-----|------------------|-----------------|-----------|-----|------------------|-----|-----------|--|-----------------|-----------|----|------------------|----|-----------|----|-----------------|-----|----|-----|----|-----|----|-----|----|-----------------|-----------|-----|-----|-----|-----|-----|-----|-----------|-----|-----|-----|-----|-----|-----|-----------|-----|-----------------|----|-----|-----|-----|------------|-----|-----|-----|-----|-----|-----|----------|-----|-----|-----|-----|----|----|---------------------|-----|----|-----|----|----|----|--|----------------------|--|--|--|--|--|--|--|------------------|-----------------|-----------|--|------------------|--|-----------|--|-----------------|-----------|--|------------------|--|-----------|--|-----------------|-----|--|-----|--|-----|--|-----|--|----|-----------|----|--|----|--|----|--|----------|----|--|----|--|----|--|-----------|----|--|----|--|----|--|------------|----|--|----|--|----|--|------------|----|--|----|--|----|--|---------------------|----|--|----|--|----|--|
| 3. Outdoor fan motor control | <p>The blowing air volume at the outdoor unit side is controlled. Receiving the operation command from the controller of indoor unit, the controller of outdoor unit controls fan speed.</p> <p>* For the fan motor, a DC motor with non-stage variable speed system is used. However, it is limited to 8 stages for reasons of controlling.</p> | <ol style="list-style-type: none"> 1) The operation command sent from the remote controller is processed by the indoor unit controller and transferred to the controller of the outdoor unit. 2) When strong wind blows at outdoor side, the operation of air conditioner continues with the fan motor stopped. 3) Whether the fan is locked or not is detected, and the operation of air conditioner stops and an alarm is displayed if the fan is locked. 4) According to each operation mode, by the conditions of outdoor temperature (To) and compressor revolution, the speed of the outdoor fan shown in the table is selected. | | | | | | | | | | | | | | | | | | | | | | | | | | | | | | | | | | | | | | | | | | | | | | | | | | | | | | | | | | | | | | | | | | | | | | | | | | | | | | | | | | | | | | | | | | | | | | | | | | | | | | | | | | | | | | | | | | | | | | | | | | | | | | | | | | | | | | | | | | | | | | | | | | | | | | |
| | <table border="1"> <thead> <tr> <th colspan="8">In cooling operation</th> </tr> <tr> <th rowspan="2">Compressor speed</th> <th>RAS-25N4AVPG-ND</th> <th colspan="2">Hz < 11.4</th> <th colspan="2">11.4 ≤ Hz ≤ 22.8</th> <th colspan="2">22.8 < Hz</th> </tr> <tr> <th>RAS-35N4AVPG-ND</th> <th colspan="2">Hz < 14.4</th> <th colspan="2">14.4 ≤ Hz ≤ 31.2</th> <th colspan="2">31.2 < Hz</th> </tr> <tr> <th>Fan speed range</th> <th colspan="2">MIN</th> <th colspan="2">MAX</th> <th colspan="2">MIN</th> <th colspan="2">MAX</th> </tr> </thead> <tbody> <tr> <td rowspan="5">To</td> <td>To ≥ 38°C</td> <td>f6</td> <td>fB</td> <td>f8</td> <td>fE</td> <td>fA</td> <td>fE</td> </tr> <tr> <td>To ≥ 28°C</td> <td>f5</td> <td>fA</td> <td>f7</td> <td>fE</td> <td>f9</td> <td>fE</td> </tr> <tr> <td>To ≥ 15°C</td> <td>f3</td> <td>f7</td> <td>f5</td> <td>f9</td> <td>f7</td> <td>fB</td> </tr> <tr> <td>To ≥ 5.5°C</td> <td>f2</td> <td>f5</td> <td>f4</td> <td>f7</td> <td>f6</td> <td>f9</td> </tr> <tr> <td>To ≥ 0°C</td> <td>f1</td> <td>f3</td> <td>f3</td> <td>f5</td> <td>f4</td> <td>f7</td> </tr> <tr> <td>When To is abnormal</td> <td>OFF</td> <td>fB</td> <td>OFF</td> <td>fE</td> <td>f1</td> <td>fE</td> </tr> </tbody> </table> | In cooling operation | | | | | | | | Compressor speed | RAS-25N4AVPG-ND | Hz < 11.4 | | 11.4 ≤ Hz ≤ 22.8 | | 22.8 < Hz | | RAS-35N4AVPG-ND | Hz < 14.4 | | 14.4 ≤ Hz ≤ 31.2 | | 31.2 < Hz | | Fan speed range | MIN | | MAX | | MIN | | MAX | | To | To ≥ 38°C | f6 | fB | f8 | fE | fA | fE | To ≥ 28°C | f5 | fA | f7 | fE | f9 | fE | To ≥ 15°C | f3 | f7 | f5 | f9 | f7 | fB | To ≥ 5.5°C | f2 | f5 | f4 | f7 | f6 | f9 | To ≥ 0°C | f1 | f3 | f3 | f5 | f4 | f7 | When To is abnormal | OFF | fB | OFF | fE | f1 | fE | <table border="1"> <thead> <tr> <th colspan="8">In heating operation</th> </tr> <tr> <th rowspan="2">Compressor speed</th> <th>RAS-25N4AVPG-ND</th> <th colspan="2">Hz < 16.8</th> <th colspan="2">16.8 ≤ Hz ≤ 33.0</th> <th colspan="2">33.0 < Hz</th> </tr> <tr> <th>RAS-35N4AVPG-ND</th> <th colspan="2">Hz < 18.0</th> <th colspan="2">18.0 ≤ Hz ≤ 35.4</th> <th colspan="2">35.4 < Hz</th> </tr> <tr> <th>Fan speed range</th> <th colspan="2">MIN</th> <th colspan="2">MAX</th> <th colspan="2">MIN</th> <th colspan="2">MAX</th> </tr> </thead> <tbody> <tr> <td rowspan="5">To</td> <td>To ≥ 10°C</td> <td colspan="2">f7</td> <td colspan="2">f8</td> <td colspan="2">f9</td> </tr> <tr> <td>To ≥ 5°C</td> <td colspan="2">f9</td> <td colspan="2">fB</td> <td colspan="2">fE</td> </tr> <tr> <td>To ≥ -3°C</td> <td colspan="2">fE</td> <td colspan="2">fE</td> <td colspan="2">fE</td> </tr> <tr> <td>To ≥ -10°C</td> <td colspan="2">fE</td> <td colspan="2">fE</td> <td colspan="2">fE</td> </tr> <tr> <td>To < -10°C</td> <td colspan="2">fE</td> <td colspan="2">fE</td> <td colspan="2">fE</td> </tr> <tr> <td>When To is abnormal</td> <td colspan="2">fE</td> <td colspan="2">fF</td> <td colspan="2">fF</td> </tr> </tbody> </table> | In heating operation | | | | | | | | Compressor speed | RAS-25N4AVPG-ND | Hz < 16.8 | | 16.8 ≤ Hz ≤ 33.0 | | 33.0 < Hz | | RAS-35N4AVPG-ND | Hz < 18.0 | | 18.0 ≤ Hz ≤ 35.4 | | 35.4 < Hz | | Fan speed range | MIN | | MAX | | MIN | | MAX | | To | To ≥ 10°C | f7 | | f8 | | f9 | | To ≥ 5°C | f9 | | fB | | fE | | To ≥ -3°C | fE | | fE | | fE | | To ≥ -10°C | fE | | fE | | fE | | To < -10°C | fE | | fE | | fE | | When To is abnormal | fE | | fF | | fF | |
| In cooling operation | | | | | | | | | | | | | | | | | | | | | | | | | | | | | | | | | | | | | | | | | | | | | | | | | | | | | | | | | | | | | | | | | | | | | | | | | | | | | | | | | | | | | | | | | | | | | | | | | | | | | | | | | | | | | | | | | | | | | | | | | | | | | | | | | | | | | | | | | | | | | | | | | | | | | | | | |
| Compressor speed | RAS-25N4AVPG-ND | Hz < 11.4 | | 11.4 ≤ Hz ≤ 22.8 | | 22.8 < Hz | | | | | | | | | | | | | | | | | | | | | | | | | | | | | | | | | | | | | | | | | | | | | | | | | | | | | | | | | | | | | | | | | | | | | | | | | | | | | | | | | | | | | | | | | | | | | | | | | | | | | | | | | | | | | | | | | | | | | | | | | | | | | | | | | | | | | | | | | | | | | | | | | | |
| | RAS-35N4AVPG-ND | Hz < 14.4 | | 14.4 ≤ Hz ≤ 31.2 | | 31.2 < Hz | | | | | | | | | | | | | | | | | | | | | | | | | | | | | | | | | | | | | | | | | | | | | | | | | | | | | | | | | | | | | | | | | | | | | | | | | | | | | | | | | | | | | | | | | | | | | | | | | | | | | | | | | | | | | | | | | | | | | | | | | | | | | | | | | | | | | | | | | | | | | | | | | | |
| Fan speed range | MIN | | MAX | | MIN | | MAX | | | | | | | | | | | | | | | | | | | | | | | | | | | | | | | | | | | | | | | | | | | | | | | | | | | | | | | | | | | | | | | | | | | | | | | | | | | | | | | | | | | | | | | | | | | | | | | | | | | | | | | | | | | | | | | | | | | | | | | | | | | | | | | | | | | | | | | | | | | | | | | | | |
| To | To ≥ 38°C | f6 | fB | f8 | fE | fA | fE | | | | | | | | | | | | | | | | | | | | | | | | | | | | | | | | | | | | | | | | | | | | | | | | | | | | | | | | | | | | | | | | | | | | | | | | | | | | | | | | | | | | | | | | | | | | | | | | | | | | | | | | | | | | | | | | | | | | | | | | | | | | | | | | | | | | | | | | | | | | | | | | | |
| | To ≥ 28°C | f5 | fA | f7 | fE | f9 | fE | | | | | | | | | | | | | | | | | | | | | | | | | | | | | | | | | | | | | | | | | | | | | | | | | | | | | | | | | | | | | | | | | | | | | | | | | | | | | | | | | | | | | | | | | | | | | | | | | | | | | | | | | | | | | | | | | | | | | | | | | | | | | | | | | | | | | | | | | | | | | | | | | |
| | To ≥ 15°C | f3 | f7 | f5 | f9 | f7 | fB | | | | | | | | | | | | | | | | | | | | | | | | | | | | | | | | | | | | | | | | | | | | | | | | | | | | | | | | | | | | | | | | | | | | | | | | | | | | | | | | | | | | | | | | | | | | | | | | | | | | | | | | | | | | | | | | | | | | | | | | | | | | | | | | | | | | | | | | | | | | | | | | | |
| | To ≥ 5.5°C | f2 | f5 | f4 | f7 | f6 | f9 | | | | | | | | | | | | | | | | | | | | | | | | | | | | | | | | | | | | | | | | | | | | | | | | | | | | | | | | | | | | | | | | | | | | | | | | | | | | | | | | | | | | | | | | | | | | | | | | | | | | | | | | | | | | | | | | | | | | | | | | | | | | | | | | | | | | | | | | | | | | | | | | | |
| | To ≥ 0°C | f1 | f3 | f3 | f5 | f4 | f7 | | | | | | | | | | | | | | | | | | | | | | | | | | | | | | | | | | | | | | | | | | | | | | | | | | | | | | | | | | | | | | | | | | | | | | | | | | | | | | | | | | | | | | | | | | | | | | | | | | | | | | | | | | | | | | | | | | | | | | | | | | | | | | | | | | | | | | | | | | | | | | | | | |
| When To is abnormal | OFF | fB | OFF | fE | f1 | fE | | | | | | | | | | | | | | | | | | | | | | | | | | | | | | | | | | | | | | | | | | | | | | | | | | | | | | | | | | | | | | | | | | | | | | | | | | | | | | | | | | | | | | | | | | | | | | | | | | | | | | | | | | | | | | | | | | | | | | | | | | | | | | | | | | | | | | | | | | | | | | | | | | |
| In heating operation | | | | | | | | | | | | | | | | | | | | | | | | | | | | | | | | | | | | | | | | | | | | | | | | | | | | | | | | | | | | | | | | | | | | | | | | | | | | | | | | | | | | | | | | | | | | | | | | | | | | | | | | | | | | | | | | | | | | | | | | | | | | | | | | | | | | | | | | | | | | | | | | | | | | | | | | |
| Compressor speed | RAS-25N4AVPG-ND | Hz < 16.8 | | 16.8 ≤ Hz ≤ 33.0 | | 33.0 < Hz | | | | | | | | | | | | | | | | | | | | | | | | | | | | | | | | | | | | | | | | | | | | | | | | | | | | | | | | | | | | | | | | | | | | | | | | | | | | | | | | | | | | | | | | | | | | | | | | | | | | | | | | | | | | | | | | | | | | | | | | | | | | | | | | | | | | | | | | | | | | | | | | | | |
| | RAS-35N4AVPG-ND | Hz < 18.0 | | 18.0 ≤ Hz ≤ 35.4 | | 35.4 < Hz | | | | | | | | | | | | | | | | | | | | | | | | | | | | | | | | | | | | | | | | | | | | | | | | | | | | | | | | | | | | | | | | | | | | | | | | | | | | | | | | | | | | | | | | | | | | | | | | | | | | | | | | | | | | | | | | | | | | | | | | | | | | | | | | | | | | | | | | | | | | | | | | | | |
| Fan speed range | MIN | | MAX | | MIN | | MAX | | | | | | | | | | | | | | | | | | | | | | | | | | | | | | | | | | | | | | | | | | | | | | | | | | | | | | | | | | | | | | | | | | | | | | | | | | | | | | | | | | | | | | | | | | | | | | | | | | | | | | | | | | | | | | | | | | | | | | | | | | | | | | | | | | | | | | | | | | | | | | | | | |
| To | To ≥ 10°C | f7 | | f8 | | f9 | | | | | | | | | | | | | | | | | | | | | | | | | | | | | | | | | | | | | | | | | | | | | | | | | | | | | | | | | | | | | | | | | | | | | | | | | | | | | | | | | | | | | | | | | | | | | | | | | | | | | | | | | | | | | | | | | | | | | | | | | | | | | | | | | | | | | | | | | | | | | | | | | | |
| | To ≥ 5°C | f9 | | fB | | fE | | | | | | | | | | | | | | | | | | | | | | | | | | | | | | | | | | | | | | | | | | | | | | | | | | | | | | | | | | | | | | | | | | | | | | | | | | | | | | | | | | | | | | | | | | | | | | | | | | | | | | | | | | | | | | | | | | | | | | | | | | | | | | | | | | | | | | | | | | | | | | | | | | |
| | To ≥ -3°C | fE | | fE | | fE | | | | | | | | | | | | | | | | | | | | | | | | | | | | | | | | | | | | | | | | | | | | | | | | | | | | | | | | | | | | | | | | | | | | | | | | | | | | | | | | | | | | | | | | | | | | | | | | | | | | | | | | | | | | | | | | | | | | | | | | | | | | | | | | | | | | | | | | | | | | | | | | | | |
| | To ≥ -10°C | fE | | fE | | fE | | | | | | | | | | | | | | | | | | | | | | | | | | | | | | | | | | | | | | | | | | | | | | | | | | | | | | | | | | | | | | | | | | | | | | | | | | | | | | | | | | | | | | | | | | | | | | | | | | | | | | | | | | | | | | | | | | | | | | | | | | | | | | | | | | | | | | | | | | | | | | | | | | |
| | To < -10°C | fE | | fE | | fE | | | | | | | | | | | | | | | | | | | | | | | | | | | | | | | | | | | | | | | | | | | | | | | | | | | | | | | | | | | | | | | | | | | | | | | | | | | | | | | | | | | | | | | | | | | | | | | | | | | | | | | | | | | | | | | | | | | | | | | | | | | | | | | | | | | | | | | | | | | | | | | | | | |
| When To is abnormal | fE | | fF | | fF | | | | | | | | | | | | | | | | | | | | | | | | | | | | | | | | | | | | | | | | | | | | | | | | | | | | | | | | | | | | | | | | | | | | | | | | | | | | | | | | | | | | | | | | | | | | | | | | | | | | | | | | | | | | | | | | | | | | | | | | | | | | | | | | | | | | | | | | | | | | | | | | | | | |
| <p>Outdoor fan speed (rpm)</p> <table border="1"> <thead> <tr> <th rowspan="2">Model name</th> <th colspan="16">Fan speed range</th> </tr> <tr> <th>f0</th> <th>f1</th> <th>f2</th> <th>f3</th> <th>f4</th> <th>f5</th> <th>f6</th> <th>f7</th> <th>f8</th> <th>f9</th> <th>fA</th> <th>fB</th> <th>fC</th> <th>fD</th> <th>fE</th> <th>fF</th> </tr> </thead> <tbody> <tr> <td>RAS-25N4AVPG-ND</td> <td>0</td> <td>300</td> <td>300</td> <td>300</td> <td>370</td> <td>450</td> <td>500</td> <td>550</td> <td>600</td> <td>600</td> <td>650</td> <td>700</td> <td>700</td> <td>700</td> <td>700</td> <td>850</td> </tr> <tr> <td>RAS-35N4AVPG-ND</td> <td>0</td> <td>300</td> <td>300</td> <td>300</td> <td>370</td> <td>450</td> <td>500</td> <td>550</td> <td>600</td> <td>650</td> <td>700</td> <td>810</td> <td>810</td> <td>810</td> <td>810</td> <td>950</td> </tr> </tbody> </table> | Model name | Fan speed range | | | | | | | | | | | | | | | | f0 | f1 | f2 | f3 | f4 | f5 | f6 | f7 | f8 | f9 | fA | fB | fC | fD | fE | fF | RAS-25N4AVPG-ND | 0 | 300 | 300 | 300 | 370 | 450 | 500 | 550 | 600 | 600 | 650 | 700 | 700 | 700 | 700 | 850 | RAS-35N4AVPG-ND | 0 | 300 | 300 | 300 | 370 | 450 | 500 | 550 | 600 | 650 | 700 | 810 | 810 | 810 | 810 | 950 | | | | | | | | | | | | | | | | | | | | | | | | | | | | | | | | | | | | | | | | | | | | | | | | | | | | | | | | | | | | | | | | | | | | | | | | | | | | | | | | | | | | | |
| Model name | | Fan speed range | | | | | | | | | | | | | | | | | | | | | | | | | | | | | | | | | | | | | | | | | | | | | | | | | | | | | | | | | | | | | | | | | | | | | | | | | | | | | | | | | | | | | | | | | | | | | | | | | | | | | | | | | | | | | | | | | | | | | | | | | | | | | | | | | | | | | | | | | | | | | | | | | | | | | | |
| | f0 | f1 | f2 | f3 | f4 | f5 | f6 | f7 | f8 | f9 | fA | fB | fC | fD | fE | fF | | | | | | | | | | | | | | | | | | | | | | | | | | | | | | | | | | | | | | | | | | | | | | | | | | | | | | | | | | | | | | | | | | | | | | | | | | | | | | | | | | | | | | | | | | | | | | | | | | | | | | | | | | | | | | | | | | | | | | | | | | | | | | | | | | | | | | | | |
| RAS-25N4AVPG-ND | 0 | 300 | 300 | 300 | 370 | 450 | 500 | 550 | 600 | 600 | 650 | 700 | 700 | 700 | 700 | 850 | | | | | | | | | | | | | | | | | | | | | | | | | | | | | | | | | | | | | | | | | | | | | | | | | | | | | | | | | | | | | | | | | | | | | | | | | | | | | | | | | | | | | | | | | | | | | | | | | | | | | | | | | | | | | | | | | | | | | | | | | | | | | | | | | | | | | | | | |
| RAS-35N4AVPG-ND | 0 | 300 | 300 | 300 | 370 | 450 | 500 | 550 | 600 | 650 | 700 | 810 | 810 | 810 | 810 | 950 | | | | | | | | | | | | | | | | | | | | | | | | | | | | | | | | | | | | | | | | | | | | | | | | | | | | | | | | | | | | | | | | | | | | | | | | | | | | | | | | | | | | | | | | | | | | | | | | | | | | | | | | | | | | | | | | | | | | | | | | | | | | | | | | | | | | | | | | |

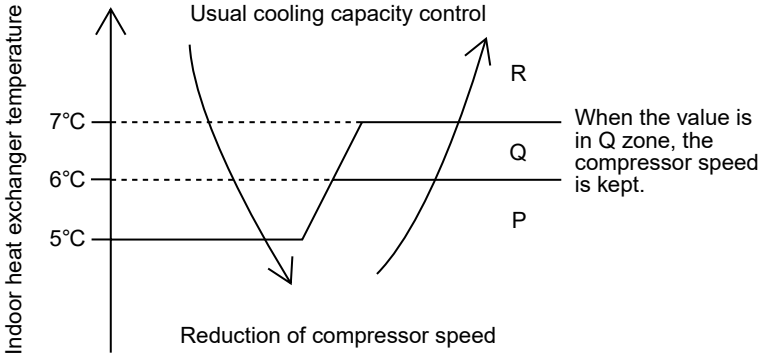
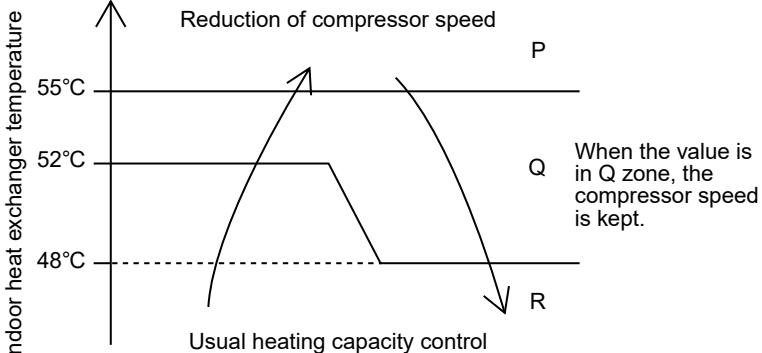
| Item | Operation flow and applicable data, etc. | Description | | | | | | | | | | | | | | | | | | | | | | | | | | |
|--|---|---|------------------------------|---------------------------|--|-----------------|-----------------|---------|---------|-----|-----|--------------|-----|-----|---------|-----|-----|---------|---------|------|------|--------------|------|------|---------|-----|------|---|
| <p>4. Capacity control</p> | <p>The cooling or heating capacity depending on the load is adjusted.</p> <p>According to difference between the setup value of temperature and the room temperature, the capacity is adjusted by the compressor revolution.</p>  | <ol style="list-style-type: none"> 1) The difference between set temperature on remote controller (Ts) and room temperature (Ta) is calculated. 2) According to the temperature difference, the correction value of Hz signal which determines the compressor speed is set up. 3) The rotating position and speed of the motor are detected by the electromotive force occurred on the motor winding with operation of the compressor. 4) According to the difference resulted from comparison of the correction value of Hz signal with the present operation Hz, the inverter output and the commutation timing are varied. 5) Change the compressor motor speed by outputting power to the compressor. <p>* The contents of control operation are same in cooling operation and heating operation</p> | | | | | | | | | | | | | | | | | | | | | | | | | | |
| <p>5. Current release control</p> | <p>This function prevents troubles on the electronic parts of the compressor driving inverter.</p> <p>This function also controls drive circuit of the compressor speed so that electric power of the compressor drive circuit does not exceed the specified value.</p>  <table border="1" data-bbox="177 1816 1002 2040"> <thead> <tr> <th rowspan="2">Mode</th> <th rowspan="2">Outdoor temperature: To (°C)</th> <th colspan="2">Current Release Value (A)</th> </tr> <tr> <th>RAS-25N4AVPG-ND</th> <th>RAS-35N4AVPG-ND</th> </tr> </thead> <tbody> <tr> <td rowspan="3">Cooling</td> <td>To ≥ 45</td> <td>6.5</td> <td>6.5</td> </tr> <tr> <td>45 > To ≥ 40</td> <td>6.8</td> <td>6.8</td> </tr> <tr> <td>To < 40</td> <td>4.5</td> <td>4.8</td> </tr> <tr> <td rowspan="3">Heating</td> <td>To ≥ 16</td> <td>12.0</td> <td>12.0</td> </tr> <tr> <td>16 > To ≥ 11</td> <td>10.5</td> <td>11.5</td> </tr> <tr> <td>To < 11</td> <td>9.0</td> <td>11.0</td> </tr> </tbody> </table> | Mode | Outdoor temperature: To (°C) | Current Release Value (A) | | RAS-25N4AVPG-ND | RAS-35N4AVPG-ND | Cooling | To ≥ 45 | 6.5 | 6.5 | 45 > To ≥ 40 | 6.8 | 6.8 | To < 40 | 4.5 | 4.8 | Heating | To ≥ 16 | 12.0 | 12.0 | 16 > To ≥ 11 | 10.5 | 11.5 | To < 11 | 9.0 | 11.0 | <ol style="list-style-type: none"> 1) The input current of the outdoor unit is detected in the inverter section of the outdoor unit. 2) According to the detected outdoor temperature, the specific value of the current is selected. 3) Whether the current value exceeds the specific value or not is judged. 4) If the current value exceeds the specified value, this function reduces the compressor speed and controls speed up to the closest one commanded from the indoor unit within the range which does not exceed the specified value. |
| Mode | Outdoor temperature: To (°C) | | | Current Release Value (A) | | | | | | | | | | | | | | | | | | | | | | | | |
| | | RAS-25N4AVPG-ND | RAS-35N4AVPG-ND | | | | | | | | | | | | | | | | | | | | | | | | | |
| Cooling | To ≥ 45 | 6.5 | 6.5 | | | | | | | | | | | | | | | | | | | | | | | | | |
| | 45 > To ≥ 40 | 6.8 | 6.8 | | | | | | | | | | | | | | | | | | | | | | | | | |
| | To < 40 | 4.5 | 4.8 | | | | | | | | | | | | | | | | | | | | | | | | | |
| Heating | To ≥ 16 | 12.0 | 12.0 | | | | | | | | | | | | | | | | | | | | | | | | | |
| | 16 > To ≥ 11 | 10.5 | 11.5 | | | | | | | | | | | | | | | | | | | | | | | | | |
| | To < 11 | 9.0 | 11.0 | | | | | | | | | | | | | | | | | | | | | | | | | |

| Item | Operation flow and applicable data, etc. | Description |
|---|---|--|
| <p>6. Release protective control by temperature of indoor heat exchanger</p> | <p><In cooling/dry operation> (Prevent-freezing control for indoor heat exchanger) In cooling/dry operation, the sensor of indoor heat exchanger detects evaporation temperature and controls the compressor speed so that temperature of the heat exchanger does not exceed the specified value.</p>  | <ol style="list-style-type: none"> 1) When temperature of the indoor heat exchanger drops below 5°C, the compressor speed is reduced. (P zone) 2) When temperature of the indoor heat exchanger rises in the range from 6°C to under 7°C, the compressor speed is kept. (Q zone) 3) When temperature of the indoor heat exchanger rises to 7°C or higher, the capacity control operation returns to the usual control in cooling operation. (R zone) |
| | <p><In heating operation> (Prevent-overpressure control for refrigerating cycle) In heating operation, the sensor of indoor heat exchanger detects condensation temperature and controls the compressor speed so that temperature of the heat exchanger does not exceed the specified value.</p>  | <ol style="list-style-type: none"> 1) When temperature of the indoor heat exchanger rises in the range from 52°C to 55°C, the compressor speed is kept. (Q zone) When temperature of the indoor heat exchanger drops in the range from 48°C to under 55°C, the compressor speed is kept. (Q zone) 2) When temperature of the indoor heat exchanger rises to 55°C or higher, the compressor speed is reduced. (P zone) 3) When temperature of the indoor heat exchanger does not rise to 52°C, or when it drops below to 48°C, the capacity control operation returns to the usual control in heating operation. (R zone) |

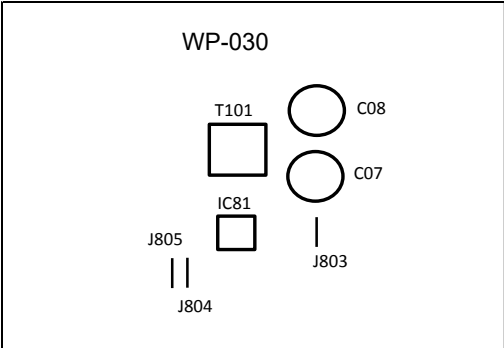
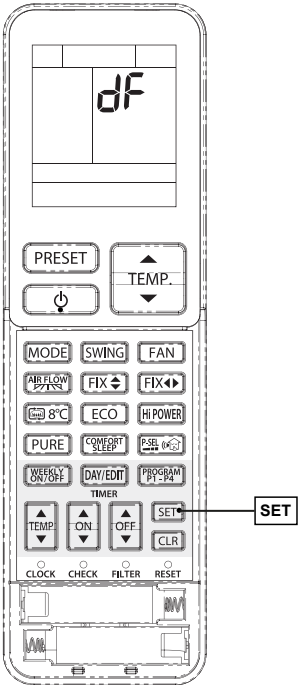
| Item | Operation flow and applicable data, etc. | Description | | | | | | | | | | | | | | | | | | | | |
|---|--|--|--------------|--------------------|-----------------|--|--|--------|--|--|--------|---|---|--------|--|---|--------|---|-----------|----|----|--|
| 7. Defrost control (Only in heating operation) | (This function removes frost adhered to the outdoor heat exchanger.) The temperature sensor of the outdoor heat exchanger (TE sensor) judges the frosting status of the outdoor heat exchanger and the defrost operation is performed with 4-way valve reverse defrost system. | The necessity of defrost operation is detected by the outdoor heat exchanger temperature (TE) and outdoor air temperature (TO). The conditions to detect the necessity of defrost operation differ in A, B, C, D or E zone each. And starting of defrost operation of each zone are explain on Table-1. | | | | | | | | | | | | | | | | | | | | |
| Start of heating operation | | | | | | | | | | | | | | | | | | | | | | |
| | | | | | | | | | | | | | | | | | | | | | | |
| | <p>* The minimum TE value and TO value between 10 and 15 minutes after heating operation has started are stored in memory as TE0 and TO0, respectively.</p> <p>** When TO < -10°C, TE are not considered.</p> | | | | | | | | | | | | | | | | | | | | | |
| | Table 1 | | | | | | | | | | | | | | | | | | | | | |
| | <table border="1"> <thead> <tr> <th>Defrost zone</th> <th>In normal TO</th> <th>In abnormal TO ***</th> </tr> </thead> <tbody> <tr> <td>A zone</td> <td>$TO \geq -10^\circ\text{C} \ \& \ (TE0-TE)-(TO0-TO) \geq 3^\circ\text{C} \ \& \ SH-SH0 \leq 2$</td> <td>$TE0-TE \geq 3^\circ\text{C} \ \& \ SH-SH0 \leq 2$</td> </tr> <tr> <td>B zone</td> <td>$TO \geq -10^\circ\text{C} \ \& \ (TE0-TE)-(TO0-TO) \geq 2^\circ\text{C} \ \& \ SH-SH0 \leq 2$</td> <td>$TE0-TE \geq 2^\circ\text{C} \ \& \ SH-SH0 \leq 2$</td> </tr> <tr> <td>C zone</td> <td colspan="2">$TO \geq -10^\circ\text{C} \ \& \ TE \leq -25^\circ\text{C} \ \& \ SH-SH0 \leq 2$</td> </tr> <tr> <td>D zone</td> <td colspan="2">$TO \geq -10^\circ\text{C} \ \& \ \text{Accumulate heating operation time} \geq e \ \text{minute} \ \& \ TE < 0^\circ\text{C}$</td> </tr> <tr> <td>E zone</td> <td>$TO < -10^\circ\text{C} \ \& \ \text{accumulate heating operation time} > e \ \text{min}$</td> <td>No E zone</td> </tr> </tbody> </table> | Defrost zone | In normal TO | In abnormal TO *** | A zone | $TO \geq -10^\circ\text{C} \ \& \ (TE0-TE)-(TO0-TO) \geq 3^\circ\text{C} \ \& \ SH-SH0 \leq 2$ | $TE0-TE \geq 3^\circ\text{C} \ \& \ SH-SH0 \leq 2$ | B zone | $TO \geq -10^\circ\text{C} \ \& \ (TE0-TE)-(TO0-TO) \geq 2^\circ\text{C} \ \& \ SH-SH0 \leq 2$ | $TE0-TE \geq 2^\circ\text{C} \ \& \ SH-SH0 \leq 2$ | C zone | $TO \geq -10^\circ\text{C} \ \& \ TE \leq -25^\circ\text{C} \ \& \ SH-SH0 \leq 2$ | | D zone | $TO \geq -10^\circ\text{C} \ \& \ \text{Accumulate heating operation time} \geq e \ \text{minute} \ \& \ TE < 0^\circ\text{C}$ | | E zone | $TO < -10^\circ\text{C} \ \& \ \text{accumulate heating operation time} > e \ \text{min}$ | No E zone | | | |
| Defrost zone | In normal TO | In abnormal TO *** | | | | | | | | | | | | | | | | | | | | |
| A zone | $TO \geq -10^\circ\text{C} \ \& \ (TE0-TE)-(TO0-TO) \geq 3^\circ\text{C} \ \& \ SH-SH0 \leq 2$ | $TE0-TE \geq 3^\circ\text{C} \ \& \ SH-SH0 \leq 2$ | | | | | | | | | | | | | | | | | | | | |
| B zone | $TO \geq -10^\circ\text{C} \ \& \ (TE0-TE)-(TO0-TO) \geq 2^\circ\text{C} \ \& \ SH-SH0 \leq 2$ | $TE0-TE \geq 2^\circ\text{C} \ \& \ SH-SH0 \leq 2$ | | | | | | | | | | | | | | | | | | | | |
| C zone | $TO \geq -10^\circ\text{C} \ \& \ TE \leq -25^\circ\text{C} \ \& \ SH-SH0 \leq 2$ | | | | | | | | | | | | | | | | | | | | | |
| D zone | $TO \geq -10^\circ\text{C} \ \& \ \text{Accumulate heating operation time} \geq e \ \text{minute} \ \& \ TE < 0^\circ\text{C}$ | | | | | | | | | | | | | | | | | | | | | |
| E zone | $TO < -10^\circ\text{C} \ \& \ \text{accumulate heating operation time} > e \ \text{min}$ | No E zone | | | | | | | | | | | | | | | | | | | | |
| | <p>*** If TO sensor is abnormal, TO value is fixed at -10°C.</p> | | | | | | | | | | | | | | | | | | | | | |
| | Table 2 | | | | | | | | | | | | | | | | | | | | | |
| | <table border="1"> <thead> <tr> <th rowspan="2">Heating operation (time)</th> <th colspan="2">Model</th> </tr> <tr> <th>RAS-25N4AVPG-ND</th> <th>RAS-35N4AVPG-ND</th> </tr> </thead> <tbody> <tr> <td>a</td> <td>41</td> <td>35</td> </tr> <tr> <td>b</td> <td>39</td> <td>31</td> </tr> <tr> <td>c</td> <td>31</td> <td>31</td> </tr> <tr> <td>d</td> <td>70</td> <td>70</td> </tr> <tr> <td>e</td> <td>90</td> <td>90</td> </tr> </tbody> </table> | Heating operation (time) | Model | | RAS-25N4AVPG-ND | RAS-35N4AVPG-ND | a | 41 | 35 | b | 39 | 31 | c | 31 | 31 | d | 70 | 70 | e | 90 | 90 | |
| Heating operation (time) | Model | | | | | | | | | | | | | | | | | | | | | |
| | RAS-25N4AVPG-ND | RAS-35N4AVPG-ND | | | | | | | | | | | | | | | | | | | | |
| a | 41 | 35 | | | | | | | | | | | | | | | | | | | | |
| b | 39 | 31 | | | | | | | | | | | | | | | | | | | | |
| c | 31 | 31 | | | | | | | | | | | | | | | | | | | | |
| d | 70 | 70 | | | | | | | | | | | | | | | | | | | | |
| e | 90 | 90 | | | | | | | | | | | | | | | | | | | | |
| | <p><Defrost operation></p> <ul style="list-style-type: none"> Defrost operation in A to C zones <ol style="list-style-type: none"> Stop operation of the compressor for 20 seconds. Invert (ON) 4-way valve 10 seconds after stop of the compressor. The outdoor fan stops at the same time when the compressor stops. When temperature of the indoor heat exchanger becomes 38°C or lower, stop the indoor fan. <p><Finish of defrost operation></p> <ul style="list-style-type: none"> Returning conditions from defrost operation to heating operation <ol style="list-style-type: none"> Temperature of outdoor heat exchanger rises to +8°C or higher. Temperature of outdoor heat exchanger is kept at +5°C or higher for 80 seconds. Defrost operation continues for 15 minutes. | <p><Returning from defrost operation></p> <ol style="list-style-type: none"> Stop operation of the compressor for approx. 50 seconds. Invert (OFF) 4-way valve approx. 40 seconds after stop of the compressor. The outdoor fan starts rotating at the same time when the compressor starts. | | | | | | | | | | | | | | | | | | | | |

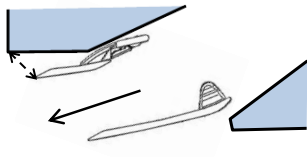
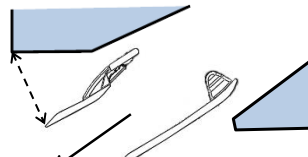
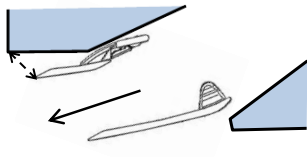
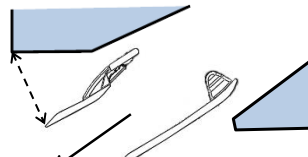
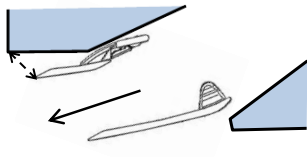
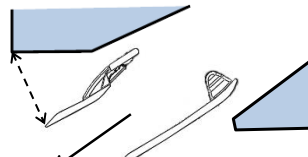
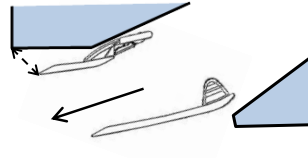
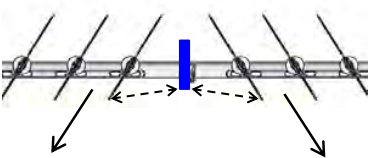
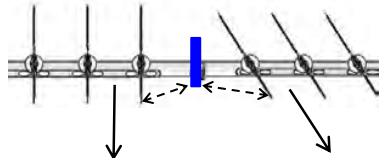
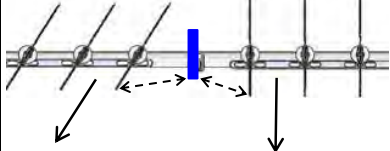
| Item | Operation flow and applicable data, etc. | Description |
|--|--|---|
| <p>7. Defrost control (Only in heating operation)</p> | <ul style="list-style-type: none"> • Strong defrost Upgrade defrost ability when normal defrost ability is not enough by increase defrosting finished operation. • Do cut the jumper J803 on CDU PCB  | <p><Finish of defrost operation for strong defrost></p> <ul style="list-style-type: none"> • Returning conditions from defrost operation to heating operation <ol style="list-style-type: none"> 1) Temperature of outdoor heat exchanger rises to +13°C or higher. 2) Temperature of outdoor heat exchanger is kept at +10°C or higher for 80 seconds. 3) Defrost operation continues for 20 minutes. |
| | <ul style="list-style-type: none"> • On demand defrost In certain extreme condition, one can manually defrost at any time by pressing button on the remote controller.  | <p><On demand defrost setting></p> <p>In AUTO or Heat mode, pass SET button and hold for 5 seconds. When this function activate, DF will be shown on display.</p> |

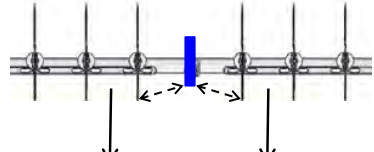
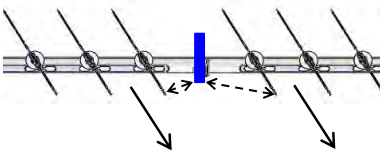
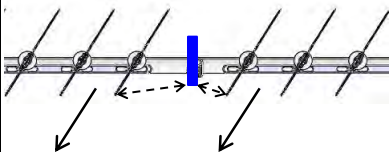
| Item | Operation flow and applicable data, etc. | Description | | | | | | |
|--|--|--|--------------------------------|--------------------|---|---|--|--|
| 8. Louver control 1) Louver position | <p>This function controls the air direction of the indoor unit.</p> <ul style="list-style-type: none"> The position is automatically controlled according to the operation mode (COOL/HEAT). The set louver position is stored in memory by the microcomputer, and the louver returns to the stored position when the next operation is performed. (Cooling/Heating memory position) <p>The angle of the louver is indicated as the louver closes fully is 0°.</p> | | | | | | | |
| 1) Louver position in cooling operation | | | | | | | | |
| <table border="1" style="width: 100%; border-collapse: collapse;"> <tr> <td style="width: 50%; text-align: center;">Manual and automatic operation</td> <td style="width: 50%; text-align: center;">HI-POWER operation</td> </tr> <tr> <td style="text-align: center;"></td> <td style="text-align: center;"></td> </tr> <tr> <td style="text-align: center;">Initial setting is directs downward (20mm)</td> <td style="text-align: center;">Default setting is directs downward (45mm)</td> </tr> </table> | | | Manual and automatic operation | HI-POWER operation |  |  | Initial setting is directs downward (20mm) | Default setting is directs downward (45mm) |
| Manual and automatic operation | HI-POWER operation | | | | | | | |
|  |  | | | | | | | |
| Initial setting is directs downward (20mm) | Default setting is directs downward (45mm) | | | | | | | |
| <p style="text-align: center;">Wide air direction</p> <p style="text-align: center;"></p> <p style="text-align: center;">Wide position is directs downward (20mm)</p> | | | | | | | | |
| <p style="text-align: center;">Wide-angle</p> <p style="text-align: center;"></p> <p>Left side louver setting is left facing (75mm) Right side louver setting is right facing (75mm)</p> | <p style="text-align: center;">Right wide</p> <p style="text-align: center;"></p> <p>Left side louver setting is front facing (55mm) Right side louver setting is right facing (75mm)</p> | <p style="text-align: center;">Left wide</p> <p style="text-align: center;"></p> <p>Left side louver setting is left facing (75mm) Right side louver setting is front facing (55mm)</p> | | | | | | |
| <p style="text-align: center;">Spot air direction</p> <p style="text-align: center;"></p> <p style="text-align: center;">Wide position is directs downward (73mm)</p> | | | | | | | | |
| <p style="text-align: center;">Spot front</p> <p style="text-align: center;"></p> <p>Left side louver setting is left facing (55mm) Right side louver setting is right facing (55mm)</p> | <p style="text-align: center;">Spot right</p> <p style="text-align: center;"></p> <p>Left side louver setting is front facing (35mm) Right side louver setting is right facing (75mm)</p> | <p style="text-align: center;">Spot left</p> <p style="text-align: center;"></p> <p>Left side louver setting is left facing (75mm) Right side louver setting is front facing (35mm)</p> | | | | | | |

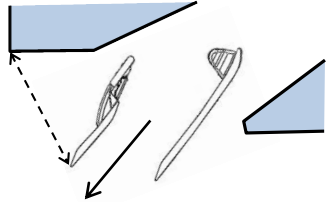
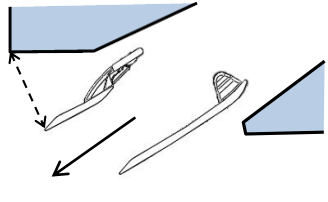
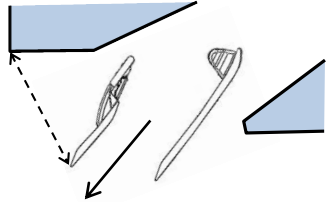
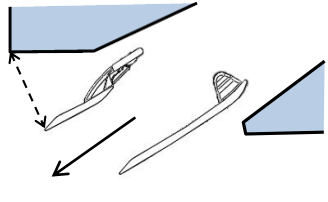
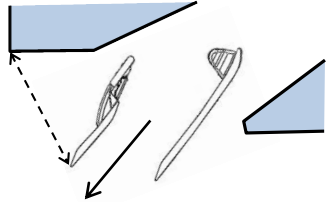
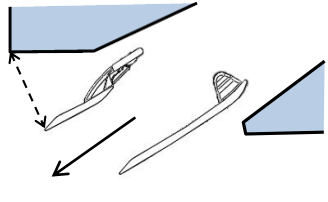
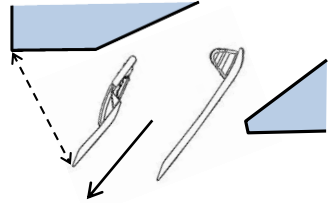
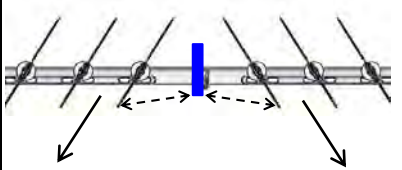
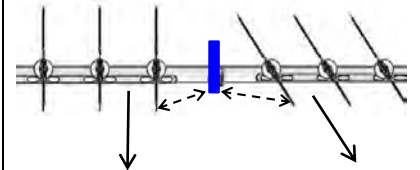
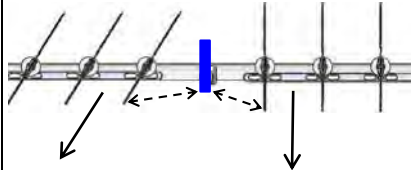
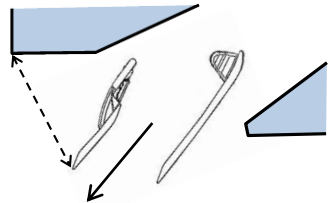
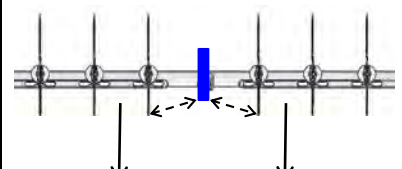
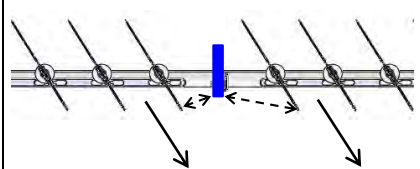
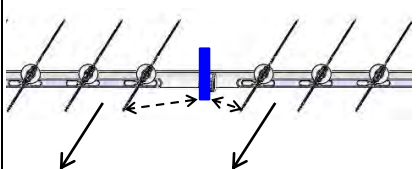
| Item | Operation flow and applicable data, etc. | Description | | | | | | |
|--|--|---|--------------------------------|--------------------|---|---|--|--|
| 8. Louver control | 2) Louver position in heating operation | | | | | | | |
| <table border="1" style="width: 100%; border-collapse: collapse;"> <tr> <td style="width: 50%; padding: 5px;">Manual and automatic operation</td> <td style="width: 50%; padding: 5px;">HI-POWER operation</td> </tr> <tr> <td style="text-align: center; padding: 10px;">  </td> <td style="text-align: center; padding: 10px;">  </td> </tr> <tr> <td style="text-align: center; padding: 5px;">Initial setting is directs downward (73mm)</td> <td style="text-align: center; padding: 5px;">Default setting is directs downward (45mm)</td> </tr> </table> | | | Manual and automatic operation | HI-POWER operation |  |  | Initial setting is directs downward (73mm) | Default setting is directs downward (45mm) |
| Manual and automatic operation | HI-POWER operation | | | | | | | |
|  |  | | | | | | | |
| Initial setting is directs downward (73mm) | Default setting is directs downward (45mm) | | | | | | | |
| <p style="text-align: center;">Wide air direction</p> <div style="text-align: center; padding: 10px;">  </div> <p style="text-align: center;">Wide position is directs downward (73mm)</p> | | | | | | | | |
| <p style="text-align: center;">Wide-angle</p> <div style="text-align: center; padding: 10px;">  </div> <p>Left side louver setting is left facing (75mm) Right side louver setting is right facing (75mm)</p> | <p style="text-align: center;">Right wide</p> <div style="text-align: center; padding: 10px;">  </div> <p>Left side louver setting is front facing (55mm) Right side louver setting is right facing (75mm)</p> | <p style="text-align: center;">Left wide</p> <div style="text-align: center; padding: 10px;">  </div> <p>Left side louver setting is left facing (75mm) Right side louver setting is front facing (55mm)</p> | | | | | | |
| <p style="text-align: center;">Spot air direction</p> <div style="text-align: center; padding: 10px;">  </div> <p style="text-align: center;">Wide position is directs downward (73mm)</p> | | | | | | | | |
| <p style="text-align: center;">Spot front</p> <div style="text-align: center; padding: 10px;">  </div> <p>Left side louver setting is left facing (55mm) Right side louver setting is right facing (55mm)</p> | <p style="text-align: center;">Spot right</p> <div style="text-align: center; padding: 10px;">  </div> <p>Left side louver setting is front facing (35mm) Right side louver setting is right facing (75mm)</p> | <p style="text-align: center;">Spot left</p> <div style="text-align: center; padding: 10px;">  </div> <p>Left side louver setting is left facing (75mm) Right side louver setting is front facing (35mm)</p> | | | | | | |

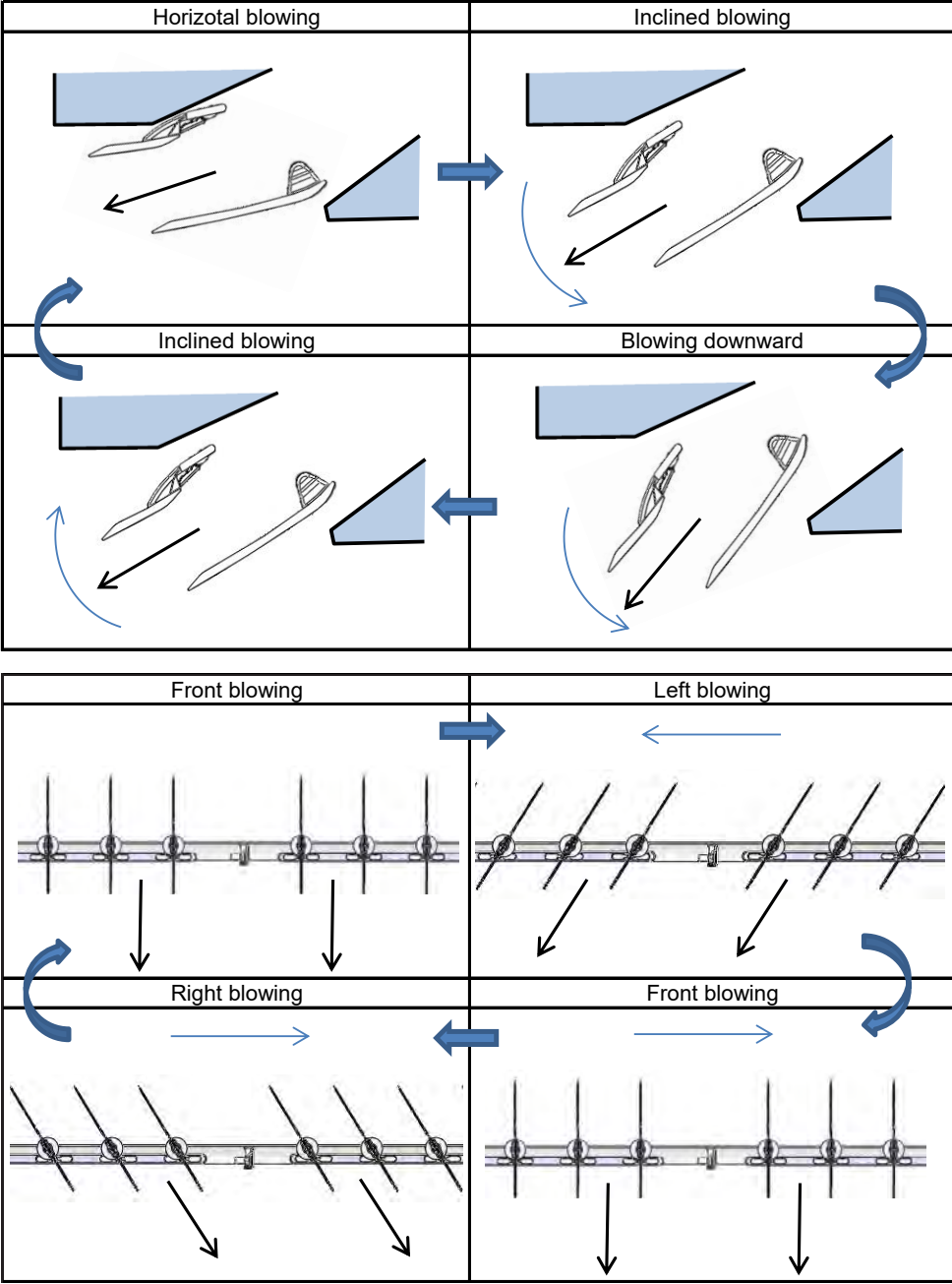
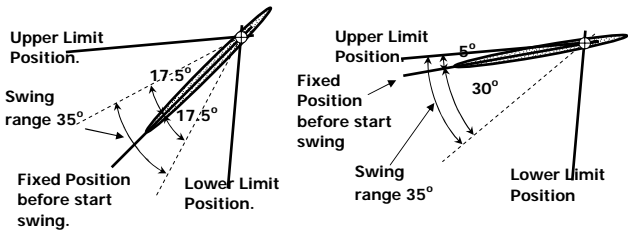
| Item | Operation flow and applicable data, etc. | Description |
|---|--|---|
| <p>8. Louver control</p> <p>2) Wind direction adjustment</p>  | | <ul style="list-style-type: none"> • The Up-Down louver position can be arbitrarily set up by pressing [FIX◀▶] button. • The Left-Right louver position can be arbitrarily set up by pressing [FIX◀▶] button. |
| <p>3) Swing</p> | <ul style="list-style-type: none"> • Swing operation is performed in range 35° with the Fixed position as the center. • If the swing range exceeded either upper or lower limit position, swing operation is performed in range 35° from the limit.  | <ul style="list-style-type: none"> • Swing When pressing [SWING] button during operation, the louver starts swinging. • Up-Down and Left-Right louver are same setting. |

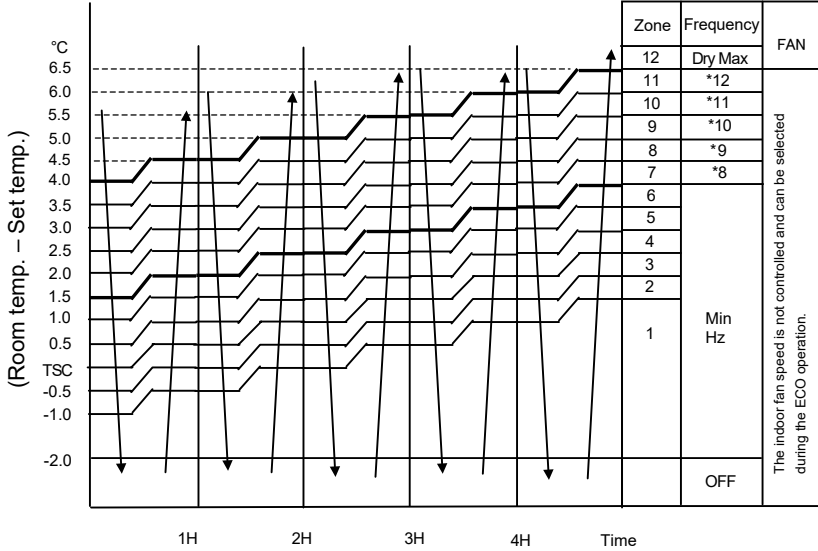
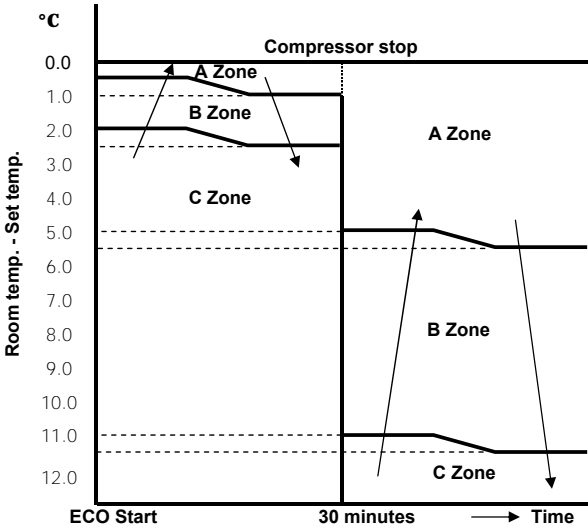
| Item | Operation flow and applicable data, etc. | Description | | | | | | | | | | | | | | | | | | |
|--------------------------------|---|-----------------|-----------------|-----------------|---------------|---|----|--------------|----|----|----|-----------------|-----------------|--------------------|---|----|-------------------|----|----|--|
| <p>9. ECO operation</p> | <p>When pressing [ECO] button on the remote controller, a Economic operation is performed.</p> <p><Cooling operation></p> <p>This function operates the air conditioner with the difference between the set and the room temperature as shown in the following figure.</p>  <p style="text-align: center;"> $* 12 \text{ (DRY max - COOL min) } / 6 \times 5 + \text{COOL min}$ $* 11 \text{ (DRY max - COOL min) } / 6 \times 4 + \text{COOL min}$ $* 10 \text{ (DRY max - COOL min) } / 6 \times 3 + \text{COOL min}$ $* 9 \text{ (DRY max - COOL min) } / 6 \times 2 + \text{COOL min}$ $* 8 \text{ (DRY max - COOL min) } / 6 \times 1 + \text{COOL min}$ </p> <table border="1" data-bbox="391 1198 1013 1276"> <thead> <tr> <th>HZ</th> <th>RAS-25N4KVPG-ND</th> <th>RAS-35N4KVPG-ND</th> </tr> </thead> <tbody> <tr> <td>Cool min (Hz)</td> <td>9</td> <td>12</td> </tr> <tr> <td>DRY max (Hz)</td> <td>17</td> <td>23</td> </tr> </tbody> </table> <p>< Heating Operation ></p>  <table border="1" data-bbox="391 1971 1013 2049"> <thead> <tr> <th>HZ</th> <th>RAS-25N4KVPG-ND</th> <th>RAS-35N4KVPG-ND</th> </tr> </thead> <tbody> <tr> <td>a (Heating min Hz)</td> <td>9</td> <td>12</td> </tr> <tr> <td>c (Heating Quiet)</td> <td>19</td> <td>21</td> </tr> </tbody> </table> | HZ | RAS-25N4KVPG-ND | RAS-35N4KVPG-ND | Cool min (Hz) | 9 | 12 | DRY max (Hz) | 17 | 23 | HZ | RAS-25N4KVPG-ND | RAS-35N4KVPG-ND | a (Heating min Hz) | 9 | 12 | c (Heating Quiet) | 19 | 21 | <p><Cooling operation></p> <ol style="list-style-type: none"> 1) The control target temperature increase 0.5°C per hour up to 2°C starting from the set temperature when ECONO has been received. 2) The indoor fan speed is depend on presetting and can change every speed after setting ECO operation. 3) The compressor speed is controlled as shown in the left figure. <p><Heating operation></p> <ol style="list-style-type: none"> 1) The difference of room temperature and set temperature are separated in to A zone, B zone and C zone. Three zone will changed again 30 minutes after ECO operation start. 2) The compressor speed is controlled as shown on the table. 3) The indoor fan speed is not controlled and can be selected during the ECO operation. |
| HZ | RAS-25N4KVPG-ND | RAS-35N4KVPG-ND | | | | | | | | | | | | | | | | | | |
| Cool min (Hz) | 9 | 12 | | | | | | | | | | | | | | | | | | |
| DRY max (Hz) | 17 | 23 | | | | | | | | | | | | | | | | | | |
| HZ | RAS-25N4KVPG-ND | RAS-35N4KVPG-ND | | | | | | | | | | | | | | | | | | |
| a (Heating min Hz) | 9 | 12 | | | | | | | | | | | | | | | | | | |
| c (Heating Quiet) | 19 | 21 | | | | | | | | | | | | | | | | | | |

| Item | Operation flow and applicable data, etc. | Description |
|-------------------------|---|---|
| 10. Temporary operation | <p>Pressing [RESET] button starts the temporary operation of [AUTO] operation. When keeping [RESET] button pressed for 10 seconds or more, the temporary [COOL] operation is performed.</p> <pre> graph TD A[Press RESET button.] --> B{Did you press [RESET] button for 3 seconds or more?} B -- NO --> C[Temporary [AUTO] operation] B -- YES --> D{Did you press [RESET] button for 10 seconds or more?} D -- YES --> E[Temporary [COOL] Operation] D -- NO --> F[Switch to [AUTO RESTART] control.] </pre> | <ol style="list-style-type: none"> 1) When pressing [RESET] button, the temporary [AUTO] operation starts. 2) When keeping [RESET] button pressed for 3 seconds or more, Pi, Pi, Pi sound is heard and [AUTO RESTART] control is changed. 3) When keeping [RESET] button pressed for 10 seconds or more, "Pi" sound is heard and the temporary [COOL] operation starts. 4) To stop the temporary operation, press the button again. |

| 11. Plasma ionizer purifier control | <p>This function cleaning the air in the room. If plasma purifier-ON signal is received while the air conditioner stops, the plasma purifier starts operation, and if it is received while the air conditioner operates, the air conditioner and the plasma purifier start operation.</p> | | | | | | | | | | | | | | | | | | | | | | | | | | | |
|-------------------------------------|---|-------------------------|------------------|--|-------------|-----------------|------|-----------------|---------------|----------------------|------------|----------------------|-----------------|----------------------|----------|-------------------------------------|--------------|----------|--|----------|--------------|---------------------------|------------------|-----------------------|--------------------------------|-------------------------|-------------------------|--|
| | <table border="1"> <thead> <tr> <th rowspan="2">Present status</th> <th colspan="2">Operation button</th> </tr> <tr> <th>PURE button</th> <th>Air conditioner</th> </tr> </thead> <tbody> <tr> <td>Stop</td> <td>Plasma purifier</td> <td>AC operation*</td> </tr> <tr> <td>Plasma purifier only</td> <td>Stop (All)</td> <td>AC + Plasma purifier</td> </tr> <tr> <td>Air conditioner</td> <td>AC + Plasma purifier</td> <td>All stop</td> </tr> <tr> <td>Joint use of AC and plasma purifier</td> <td>AC operation</td> <td>All stop</td> </tr> </tbody> </table> <table border="1"> <thead> <tr> <th></th> <th>Louver*1</th> <th>Fan speed *2</th> </tr> </thead> <tbody> <tr> <td>Plasma purifier operation</td> <td>Cooling position</td> <td>AUTO, L, L+, M, M+, H</td> </tr> <tr> <td>AC + Plasma purifier operation</td> <td>Follows to AC operation</td> <td>Follows to AC operation</td> </tr> </tbody> </table> | Present status | Operation button | | PURE button | Air conditioner | Stop | Plasma purifier | AC operation* | Plasma purifier only | Stop (All) | AC + Plasma purifier | Air conditioner | AC + Plasma purifier | All stop | Joint use of AC and plasma purifier | AC operation | All stop | | Louver*1 | Fan speed *2 | Plasma purifier operation | Cooling position | AUTO, L, L+, M, M+, H | AC + Plasma purifier operation | Follows to AC operation | Follows to AC operation | <p>* When the previous operation was the operation of air conditioner + plasma purifier, an operation of air conditioner + plasma purifier starts by pushing AC button on the remote controller. (Operation of air conditioner + plasma purifier is stored in memory.)</p> <p>* 1 Swing is available</p> <p>* 2 Fan speed is Fan Auto mode varies in order, (M + 1) → (L) → (L-) → (SL).</p> |
| Present status | Operation button | | | | | | | | | | | | | | | | | | | | | | | | | | | |
| | PURE button | Air conditioner | | | | | | | | | | | | | | | | | | | | | | | | | | |
| Stop | Plasma purifier | AC operation* | | | | | | | | | | | | | | | | | | | | | | | | | | |
| Plasma purifier only | Stop (All) | AC + Plasma purifier | | | | | | | | | | | | | | | | | | | | | | | | | | |
| Air conditioner | AC + Plasma purifier | All stop | | | | | | | | | | | | | | | | | | | | | | | | | | |
| Joint use of AC and plasma purifier | AC operation | All stop | | | | | | | | | | | | | | | | | | | | | | | | | | |
| | Louver*1 | Fan speed *2 | | | | | | | | | | | | | | | | | | | | | | | | | | |
| Plasma purifier operation | Cooling position | AUTO, L, L+, M, M+, H | | | | | | | | | | | | | | | | | | | | | | | | | | |
| AC + Plasma purifier operation | Follows to AC operation | Follows to AC operation | | | | | | | | | | | | | | | | | | | | | | | | | | |
| | <pre> graph TD subgraph "Sending plasma purifier-ON" direction TB S1[1 Air conditioner stops] --> O1[Operation lamp ON *1] O1 --> M1[Memory position of louver/COOL *2] M1 --> F1[Fan ON] F1 --> P1[Plasma purifier ON] P1 --> OP1[Plasma purifier operation] S2[2 Air conditioner operates] --> S2_1[Start of plasma purifier-ON] S2_1 --> A1[Air conditioner + Plasma purifier operate] end subgraph "Sending plasma purifier-OFF" direction TB S3[3 Plasma purifier operates] --> O2[Operation lamp OFF] O2 --> F2[Fan stop] F2 --> P2[Plasma purifier-OFF] P2 --> L2[Louver close] L2 --> A2[All stop] S4[4 Air conditioner + Plasma purifier operate] --> F3[Filter-OFF] F3 --> A3[Air conditioner operates] end </pre> | | | | | | | | | | | | | | | | | | | | | | | | | | | |

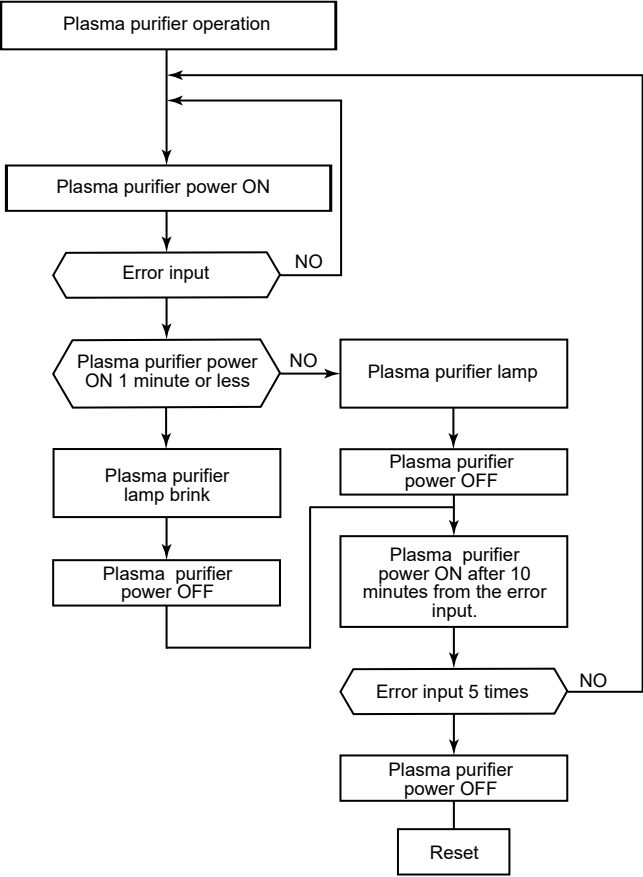
| Item | Operation flow and applicable data, etc. | Description | | | | | | | | | | | | | | |
|--|---|---|-------|--|-------|------------------------------|-------|---------------------------------|-------|-----------------------------|------|---|--|---|--|--|
| <p>11. Plasma ionizer purifier control [Detection of abnormality]</p>  <pre> graph TD Start[Plasma purifier operation] --> PowerON[Plasma purifier power ON] PowerON --> ErrorInput{Error input} ErrorInput -- NO --> Power1min{Plasma purifier power ON 1 minute or less} ErrorInput -- YES --> PowerOFF1[Plasma purifier power OFF] PowerOFF1 --> PowerON Power1min -- NO --> LampON[Plasma purifier lamp] Power1min -- YES --> PowerOFF2[Plasma purifier power OFF] PowerOFF2 --> PowerON LampON --> PowerOFF3[Plasma purifier power OFF] PowerOFF3 --> PowerON10min[Plasma purifier power ON after 10 minutes from the error input.] PowerON10min --> ErrorInput5{Error input 5 times} ErrorInput5 -- NO --> PowerOFF4[Plasma purifier power OFF] PowerOFF4 --> Reset[Reset] ErrorInput5 -- YES --> PowerOFF5[Plasma purifier power OFF] PowerOFF5 --> PowerON </pre> <p>Reset by RESET button or by the stop direction from the remote controller.</p> <p>* When the breaker is turned [ON] (In restart time after power failure) or RESET button is pressed the air purifier is not turned on until the integrated operation time of the indoor fan exceeds 1 hour after operation start (It is not the Plasma ionizer purifier operation time). It is the safety measures considering an incomplete drain when electric dust collector has been cleaned with water.</p> | <p>1. Purpose The air purifying control function is to alert the user to trouble in the plasma purifier operation.</p> <p>2. Description Trouble is determined to have occurred (indicated by the plasma purifier lamp indicator) in the following two cases.</p> <ol style="list-style-type: none"> 1) When the panel switch has been set to OFF by the opening of the air inlet grille, etc. 2) When an abnormal discharge caused by a symptom such as the build-up of dirt has been detected while the air purifier is ON <p>* Trouble case are deemed to have occurred when the action concerned continues for more than one second.</p> <p>3. Operation The sequence that plasma ionizer purifier lamp indicator is turned on are described in the left flowchart.</p> <ol style="list-style-type: none"> 1) A trouble detected within 1 minute after activation of the air is immediately judged as an error and the plasma ionizer purifier lamp indicator goes on. 2) In case that 1 minute passed after activation of the plasma ionizer purifier, it is turned off while the PURE indicator keeps ON. After 10 minutes passed, restart the plasma ionizer purifier and an error is judged again. | <p>1. Purpose This function detects error on the refrigerating cycle or error on the compressor, and performs protective control.</p> <p>2. Operation Control of the compressor speed The speed control is performed as described in the left table based upon the discharge temperature.</p> | | | | | | | | | | | | | | |
| <p>12. Discharge temperature control</p> <table border="1" data-bbox="159 1713 922 2047"> <thead> <tr> <th>Td value</th> <th>Control operation</th> </tr> </thead> <tbody> <tr> <td>117°C</td> <td>Judges as an error and stops the compressor.</td> </tr> <tr> <td>115°C</td> <td>Reduce the compressor speed.</td> </tr> <tr> <td>106°C</td> <td>Reduce slowly compressor speed.</td> </tr> <tr> <td>103°C</td> <td>Keeps the compressor speed.</td> </tr> <tr> <td>96°C</td> <td>If the operation is performed with lower speed than one commanded by the serial signal, speed is slowly raised up to the commanded speed.</td> </tr> <tr> <td></td> <td>Operates with speed commanded by the serial signal.</td> </tr> </tbody> </table> | Td value | Control operation | 117°C | Judges as an error and stops the compressor. | 115°C | Reduce the compressor speed. | 106°C | Reduce slowly compressor speed. | 103°C | Keeps the compressor speed. | 96°C | If the operation is performed with lower speed than one commanded by the serial signal, speed is slowly raised up to the commanded speed. | | Operates with speed commanded by the serial signal. | | |
| Td value | Control operation | | | | | | | | | | | | | | | |
| 117°C | Judges as an error and stops the compressor. | | | | | | | | | | | | | | | |
| 115°C | Reduce the compressor speed. | | | | | | | | | | | | | | | |
| 106°C | Reduce slowly compressor speed. | | | | | | | | | | | | | | | |
| 103°C | Keeps the compressor speed. | | | | | | | | | | | | | | | |
| 96°C | If the operation is performed with lower speed than one commanded by the serial signal, speed is slowly raised up to the commanded speed. | | | | | | | | | | | | | | | |
| | Operates with speed commanded by the serial signal. | | | | | | | | | | | | | | | |

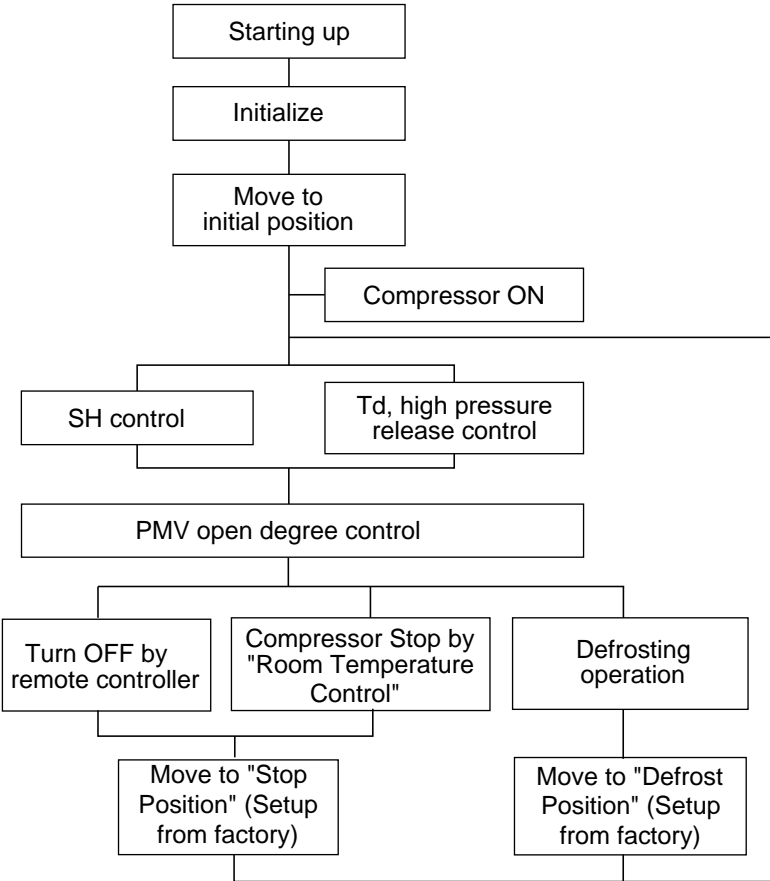
| Item | Operation flow and applicable data, etc. | Description | | | | | | | | | | | | | | | | | | | | | |
|---|--|---|-------------------|------|------|--|------|------|------------------------------|------|------|---------------------------------|------|------|-----------------------------|------|------|---|--|--|---|--|--|
| <p>13. High pressure control</p> <table border="1" data-bbox="172 297 938 638"> <thead> <tr> <th>Cooling (TE)</th> <th>Heating (TC)</th> <th>Control operation</th> </tr> </thead> <tbody> <tr> <td>63°C</td> <td>62°C</td> <td>Judges as an error and stops the compressor.</td> </tr> <tr> <td>63°C</td> <td>57°C</td> <td>Reduce the compressor speed.</td> </tr> <tr> <td>61°C</td> <td>55°C</td> <td>Reduce slowly compressor speed.</td> </tr> <tr> <td>59°C</td> <td>53°C</td> <td>Keeps the compressor speed.</td> </tr> <tr> <td>55°C</td> <td>49°C</td> <td>If the operation is performed with lower speed than one commanded by the serial signal, speed is slowly raised up to the commanded speed.</td> </tr> <tr> <td></td> <td></td> <td>Operates with speed commanded by the serial signal.</td> </tr> </tbody> </table> | Cooling (TE) | Heating (TC) | Control operation | 63°C | 62°C | Judges as an error and stops the compressor. | 63°C | 57°C | Reduce the compressor speed. | 61°C | 55°C | Reduce slowly compressor speed. | 59°C | 53°C | Keeps the compressor speed. | 55°C | 49°C | If the operation is performed with lower speed than one commanded by the serial signal, speed is slowly raised up to the commanded speed. | | | Operates with speed commanded by the serial signal. | | <p>1. Purpose This function detects error on the refrigerating cycle or error on the compressor, and performs protective control.</p> <p>2. Operation</p> <ul style="list-style-type: none"> - TE or TC sensor control - Control of the compressor speed The speed control is performed as described in the left table. - High pressure switch control compressor are shut down when discharge pressure (Pd) reaches or exceeds 3.85 MPa - The compressor restart prevention timer (3 min) is set, and the control terminated. |
| Cooling (TE) | Heating (TC) | Control operation | | | | | | | | | | | | | | | | | | | | | |
| 63°C | 62°C | Judges as an error and stops the compressor. | | | | | | | | | | | | | | | | | | | | | |
| 63°C | 57°C | Reduce the compressor speed. | | | | | | | | | | | | | | | | | | | | | |
| 61°C | 55°C | Reduce slowly compressor speed. | | | | | | | | | | | | | | | | | | | | | |
| 59°C | 53°C | Keeps the compressor speed. | | | | | | | | | | | | | | | | | | | | | |
| 55°C | 49°C | If the operation is performed with lower speed than one commanded by the serial signal, speed is slowly raised up to the commanded speed. | | | | | | | | | | | | | | | | | | | | | |
| | | Operates with speed commanded by the serial signal. | | | | | | | | | | | | | | | | | | | | | |
| <p>14. Pulse Modulating valve (P.M.V.) control</p> <p>This function controls throttle amount of the refrigerant in the refrigerating cycle. According to operating status of the air conditioner, this function also controls the open degree of valve with an expansion valve with pulse Modulation.</p>  <pre> graph TD Start[Starting up] --> Init[Initialize] Init --> Move[Move to initial position] Move --> Comp[Compressor ON] Comp --> SH[SH control] Comp --> Td[Td, high pressure release control] SH --> PMV[PMV open degree control] Td --> PMV PMV --> Off[Turn OFF by remote controller] PMV --> Stop[Compressor Stop by "Room Temperature Control"] PMV --> Defrost[Defrosting operation] Off --> StopPos[Move to "Stop Position" (Setup from factory)] Stop --> StopPos Defrost --> DefrostPos[Move to "Defrost Position" (Setup from factory)] </pre> <p>* SH (Super Heat amount) = Ts (Temperature of suction pipe of the compressor) – Tc or Te (Heat exchanger temperature at evaporation side)</p> <p>* PMV: Pulse Modulating Valve</p> | | <ol style="list-style-type: none"> 1) When starting the operation, move the valve once until it fits to the stopper. (Initialize) * In this time, "Click" sound may be heard. 2) Adjust the open degree of valve by super heat amount. (SH control) 3) If the discharge temperature was excessively up, adjust the open degree of valve so that it is in the range of set temperature. (Discharge temp. control) 4) When defrost operation is performed, the open degree of valve is adjusted according to each setup conditions during preparation for defrost and during defrost operation (4-way valve is inversed.). 5) When operation is OFF by the remote controller or when compressor is OFF by room temperature control, the open degree of valve is adjusted to the stop position. | | | | | | | | | | | | | | | | | | | | | |

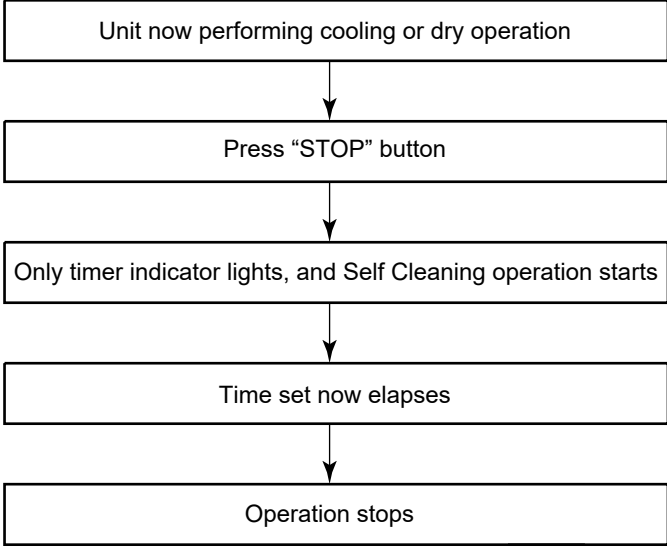
| Item | Operation flow and applicable data, etc. | Description | | | | | | | | | | | | | |
|--|---|--|----------------|------------------------------|-----------------------------|------------------|--|----------------------|----------|-------------------------|--------------------------------------|--|-----------------|----------|--|
| <p>15. Self-Cleaning function</p> |  <pre> graph TD A[Unit now performing cooling or dry operation] --> B[Press "STOP" button] B --> C[Only timer indicator lights, and Self Cleaning operation starts] C --> D[Time set now elapses] D --> E[Operation stops] </pre> <ul style="list-style-type: none"> • During Self-Cleaning operations: The louver opens slightly. The indoor fan operates continuously at a speed of 500 rpm. <p>Self-Cleaning operation times</p> <table border="1" data-bbox="397 1227 1262 1576"> <thead> <tr> <th></th> <th>Operation time</th> <th>Self-Cleaning operation time</th> </tr> </thead> <tbody> <tr> <td rowspan="2">Cooling: Auto (cooling) Dry</td> <td>Up to 10 minutes</td> <td>No Self-Cleaning operation performed (0 minutes)</td> </tr> <tr> <td>10 minutes or longer</td> <td>30 mins.</td> </tr> <tr> <td>Heating: Auto (heating)</td> <td colspan="2" rowspan="3">No Self-Cleaning operation performed</td> </tr> <tr> <td>Auto (fan only)</td> </tr> <tr> <td>Shutdown</td> </tr> </tbody> </table> <ul style="list-style-type: none"> • To stop an ongoing Self-Cleaning operation at any time Press the start/stop button on the remote controller twice during the Self-Cleaning operation. (After pressing the button for the first time, press it for the second time without delay (within 10 minutes).) | | Operation time | Self-Cleaning operation time | Cooling: Auto (cooling) Dry | Up to 10 minutes | No Self-Cleaning operation performed (0 minutes) | 10 minutes or longer | 30 mins. | Heating: Auto (heating) | No Self-Cleaning operation performed | | Auto (fan only) | Shutdown | <p>1. Purpose</p> <p>The Self-Cleaning operation is to minimize the growth of mold, bacteria etc. by running the fan and drying so as to keep the inside of the air conditioner clean.</p> <p>Self-Cleaning operation</p> <p>When the cooling or dry operation shuts down, the unit automatically starts the Self-Cleaning operation which is then performed for the specified period based on duration of the operation which was performed prior to the shutdown, after which the Self-Cleaning operation stops. (The Self-Cleaning operation is not performed after a heating operation.)</p> <p>2. Operation</p> <ol style="list-style-type: none"> 1) When the stop signal from the remote controller or timer-off function is received, only the timer indicator light. 2) The period of the Self-Cleaning operation is determined by the duration of the operation performed prior to the reception of the stop code. 3) After the Self-Cleaning operation has been performed for the specified period, the unit stops operating. |
| | Operation time | Self-Cleaning operation time | | | | | | | | | | | | | |
| Cooling: Auto (cooling) Dry | Up to 10 minutes | No Self-Cleaning operation performed (0 minutes) | | | | | | | | | | | | | |
| | 10 minutes or longer | 30 mins. | | | | | | | | | | | | | |
| Heating: Auto (heating) | No Self-Cleaning operation performed | | | | | | | | | | | | | | |
| Auto (fan only) | | | | | | | | | | | | | | | |
| Shutdown | | | | | | | | | | | | | | | |

| Item | Operation flow and applicable data, etc. | Description |
|------|--|-------------|
|------|--|-------------|

15. Self-Cleaning function

15-1-1. Self-Cleaning diagram

| | | | |
|-------------------|---|----------------|--|
| Operation display | ON | OFF | OFF |
| FCU fan | ON rpm is depend on presetting. | ON (500RPM) | OFF |
| FCU louver | OPEN | OPEN (12.7°) | CLOSE |
| Timer display | ON or OFF depend on presetting of timer function. | ON | ON or OFF depend on presetting of timer function. |
| Compressor | ON or OFF depend on presetting per room temperature. | OFF | OFF |
| CDU fan | ON or OFF depend on presetting per room temperature. | OFF | OFF |

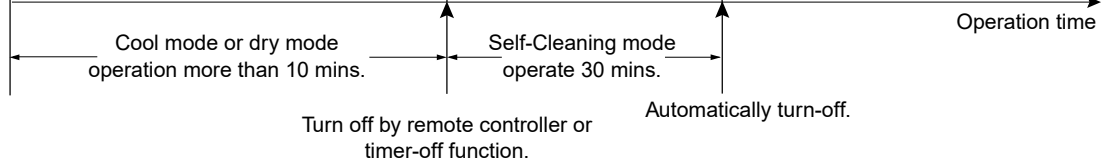

15-1-2. Self-Cleaning function release

How to set/cancel Self-Cleaning function

To set/cancel the Self-Cleaning function, proceed as follows:

- Setting diagnosis code "06" on remote controller (See detail of setting diagnosis code in 15-1-1)
- Turn on the power supply to air conditioner, after that press [RESET] button on air conditioner 1 time to turn on the air conditioner (The LED display will show in operation LED) (Fig. 7-9-1)
- Take the remote controller to direction of LED display on air conditioner, press button up (▲) at ON of the remote controller (Fig. 15-1-2) 1 time to send the code "07" (within 3 sec. after press [RESET] button), then air conditioner will shutdown automatically. Also, LED display will show flash follow the table below.

- Set or Cancel Self-Cleaning function by push the RESET button on air conditioner. When setting is changed, the sound warning will alarm "Beep". The setting is changed following below.

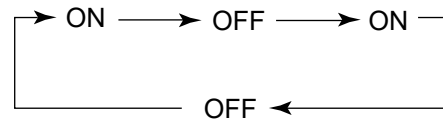

- Turn on air conditioner again by remote controller to confirm setting.

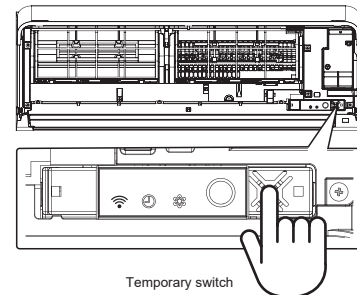

Fig. 15-1-1

| Self-cleaning function | Operation LED | Timer LED |
|------------------------|---------------|------------|
| ON | flash 1 Hz | not flash |
| OFF | flash 1 Hz | Flash 1 Hz |

Note) Table above will show current status of Self-Cleaning function

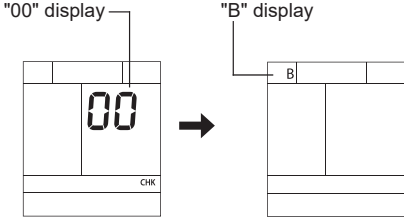

Fig. 15-1-2

| Item | Operation flow and applicable data, etc. | Description | | | | | | | | | | | | | | | |
|---|--|---|-------------|-------------|---------------|---|----|-----------------|----|----|---------------|---|----|-----------------|----|----|--|
| <p>16. Remote-A or B selection</p> | <p>Setting the remote controller</p> <p>To separate using of remote control for each indoor unit in case of 2 air conditioner are installed nearby.</p> <p>Remote Control B Setup.</p> <ol style="list-style-type: none"> 1) Press RESET button on the indoor unit to turn the air conditioner ON. 2) Point the remote control at the indoor unit. 3) Push and hold CHK ● button on the Remote Control by the tip of the pencil. "00" will be shown on the display. 4) Press MODE ● during pushing CHK ●. "B" will show on the display and "00" will disappear and the air conditioner will turn OFF. The Remote Control B is memorized. <p>Note : 1. Repeat above step to reset Remote Control to be A. 2. Remote Control A has not "A" display. 3. Default setting of Remote Control from factory is A.</p>  | <ol style="list-style-type: none"> 1. Purpose This operation is to operate only one indoor unit using one remote controller. 2. Description When operating one indoor unit in a situation where two indoor units have been installed in the same room or nearby rooms, this operation prevents the remote controller signal from being received simultaneously by both units, thus preventing both units from operating. 3. Operation The indoor unit on which the remote controller selection has been set to B receives the signal of the remote controller also set to B. (At the factory the remote controller selection is set to A on all the indoor units. There is no A setting display.) | | | | | | | | | | | | | | | |
| <p>17. QUIET mode</p> | <p>The "Quiet mode" selected from [FAN] button;</p> <ul style="list-style-type: none"> - The fan of the indoor unit will be restricted the revolving speed at speed UL. - The compressor speed is controlled as shown in the figure. <table border="1" data-bbox="371 1238 884 1391"> <thead> <tr> <th>Model</th> <th>25N4KVPG-ND</th> <th>35N4KVPG-ND</th> </tr> </thead> <tbody> <tr> <td>Cool min (Hz)</td> <td>9</td> <td>12</td> </tr> <tr> <td>Quiet Cool (Hz)</td> <td>20</td> <td>23</td> </tr> <tr> <td>Heat min (Hz)</td> <td>9</td> <td>12</td> </tr> <tr> <td>Quiet Heat (Hz)</td> <td>19</td> <td>21</td> </tr> </tbody> </table> <p>The " Quiet mode " is canceled by [FAN] button is pressed to select other speed.</p> | Model | 25N4KVPG-ND | 35N4KVPG-ND | Cool min (Hz) | 9 | 12 | Quiet Cool (Hz) | 20 | 23 | Heat min (Hz) | 9 | 12 | Quiet Heat (Hz) | 19 | 21 | <p>Quiet mode is the system which, control the revolving speed of indoor fan to work constantly at lower than speed L. In addition, noise level of indoor unit is less than usual.</p> <p>Remarks :</p> <ol style="list-style-type: none"> 1. Quiet mode is unable to work in dry mode. 2. Quiet mode is appropriate to work with less cooling load and less heating load condition. Because of the fan speed may not enough the cooling capacity or heating capacity. |
| Model | 25N4KVPG-ND | 35N4KVPG-ND | | | | | | | | | | | | | | | |
| Cool min (Hz) | 9 | 12 | | | | | | | | | | | | | | | |
| Quiet Cool (Hz) | 20 | 23 | | | | | | | | | | | | | | | |
| Heat min (Hz) | 9 | 12 | | | | | | | | | | | | | | | |
| Quiet Heat (Hz) | 19 | 21 | | | | | | | | | | | | | | | |
| <p>18. COMFORT SLEEP</p> | <p>Cooling mode</p> <ul style="list-style-type: none"> • The preset temperature will increase as show on ECO operation (Item No. 9) • Press the [COMFORT SLEEP] button to choose the operating hours. Repeat pressing to select the hours. (1hr, 3hr, 5hr or 9hr) • If the [COMFORT SLEEP] button is pressed again means cancel comfort sleep mode. <p>Heating mode</p> <ul style="list-style-type: none"> • The preset temperature will drop down as show on ECO operation (Item No. 9) • Press the [COMFORT SLEEP] button to choose the operating hours. Repeat pressing to select thehours. (1hr, 3hr, 5hr or 9 hr) • If the [COMFORT SLEEP] button is pressed again means cancel comfort sleep mode. | <p>The principles of comfort sleep mode are:</p> <ul style="list-style-type: none"> • Quietness for more comfortable. When room temperature reach setting temperature • Save energy by changing room temperature automatically. • The air condition can shut down by itself automatically. <p>Remarks:</p> <ol style="list-style-type: none"> 1. Comfort sleep mode will not operate in dry mode and fan only mode. | | | | | | | | | | | | | | | |

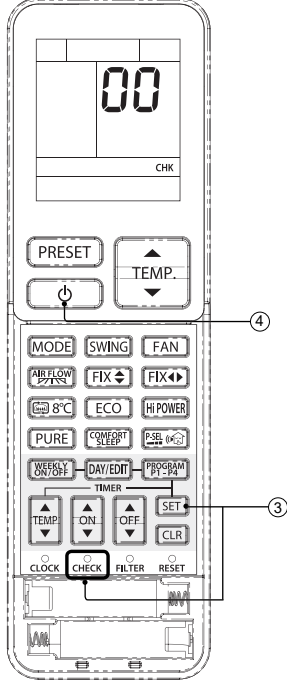
| Item | Operation flow and applicable data, etc. | Description |
|---------------------------------|---|---|
| <p>19. Short Timer</p> | <p>In the normal condition, after switching one circuit breaker, 3-minute delay time for compressor and 1 hour for plasma air purifier are set for the maintenance of the unit.</p>  | <p>Purpose To start the unit immediately for the purpose of testing, trial...etc, short timer can be used. maintenance of the unit.</p> <p>Short Timer Setting</p> <ol style="list-style-type: none"> ① Press [⏻] button to turn the unit OFF. ② Set the operation mode or plasma air purifier on the remote control without sending the signal to the unit. ③ Use the tip of the pencil to push the [CHK] button and hold, "00" will show on display, then press [SET] button to make "00" disappear. ④ Press [⏻] button to turn the unit ON. ⑤ When short timer is activated, all setting on the remote operates immediately, besides, all indications on front panel turns ON continuously for 3 seconds. |
| <p>20. Hi-POWER Mode</p> | <p>([Hi-POWER] button on the remote controller is pressed)</p> <p>When [Hi-POWER] button is pressed while the indoor unit is in Auto, Cooling or Heating operation, Hi-POWER mark is indicated on the display of the remote controller and the unit operates as follows.</p> <ol style="list-style-type: none"> 1. Automatic operation <ul style="list-style-type: none"> • The indoor unit operates in according to the current operation. 2. Cooling operation <ul style="list-style-type: none"> • The preset temperature drops 1°C (The value of the preset temperature on the remote controller does not change.) The indoor unit's fan speed level increase 1 tap 3. Heating operation <ul style="list-style-type: none"> • The preset temperature increases 2°C (The value of the preset temperature on the remote controller does not change.) The indoor unit's fan speed level increase 1 tap 4. The Hi-POWER mode can not be set in Dry operation | <p>* The Hi-POWER operation will be cancelled when press [Hi-POWER] button again.</p> |

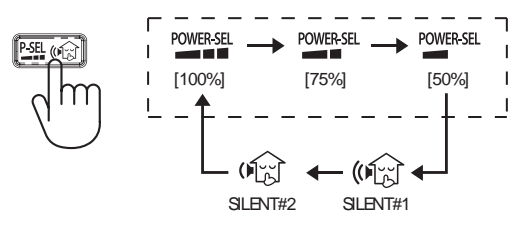
| Item | Operation flow and applicable data,etc | Description |
|---------------------------------|--|---|
| 21. POWER Selection Mode | <p>([POWER-SEL] button on the remote controller is pressed)</p> <ul style="list-style-type: none"> – Power Selection 75% is 75% of maximum current. – Power Selection 50% is 50% of rate maximum current. <p>POWER-SELECTION AND SILENT OPERATION</p>  | <p>1. Purpose</p> <p>The function is used when its circuit breaker is shared with other electrical appliances. It limits the maximum current/ power consumption to 100%, 75% or 50%.</p> <p>The lower the percentage, the higher the saving and also the longer the compressor lifetime.</p> <p>2. Description</p> <p>When the level is selected, Power-SEL level flashes on LCD display for 3 seconds. In case of 75% and 50% level, number "75" or "50" also flashes for 2 seconds.</p> <p>Note : Due to the reason that POWER SELECT FUNCTION limits the maximum current, inadequate capacity may occur.</p> |

| | | |
|-----------------------------|--|--|
| 22. Silent Operation | <p>Silent button on remote controller is pressed.</p> <p>Silent 1: Cooling/heating capacity is limited maximum for 70% of rated. Only compressor speed is limited.</p> <p>Silent 2: CDU sound level is limited for lowest CDU sound level. Compressor and CDU fan speed are limited.</p> | <p>This function is used when the user need to keep silent at outdoor side. It is limit maximum compressor speed and CDU fan speed. Sound level can be implemented by 2 silent level.</p> <p>Sound level: Rated level > Silent 1 > Silent 2</p> <p>Note: Due to Silent operation reason, In adequate cooling/heating capacity may occur.</p> |
|-----------------------------|--|--|

Silent Operation description

| Model | Silent Operation | Cooling | | Heating | |
|-----------------|------------------|-----------------------------|---------------------|-----------------------------|---------------------|
| | | Compressoar frequency (rps) | CDU Fan speed (rpm) | Compressoar frequency (rps) | CDU Fan speed (rpm) |
| RAS-25N4AVPG-ND | Silent1 | 16 | normal | 25 | normal |
| | Silent2 | 11 | 700 | 17 | 700 |
| RAS-35N4AVPG-ND | Silent1 | 19 | normal | 25 | normal |
| | Silent2 | 14 | 700 | 18 | 700 |

POWER-SELECTION AND SILENT OPERATION

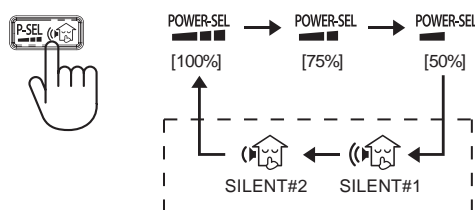







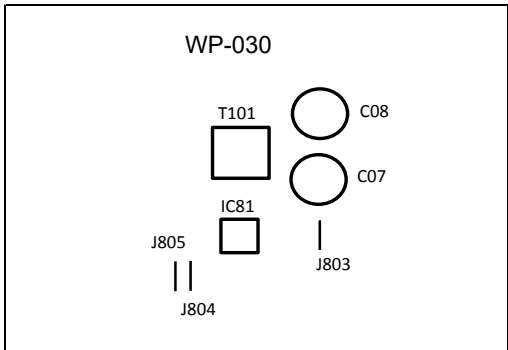

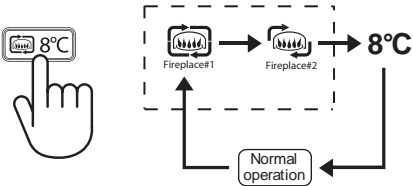
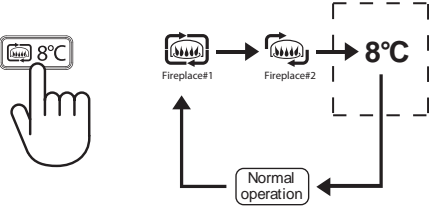



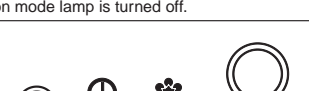

| Item | Operation flow and applicable data,etc | Description |
|----------------------------------|--|--|
| 23. Outdoor Quiet control | <p><With Quiet control/Non-select method></p> <div style="border: 1px solid black; padding: 5px; margin-bottom: 10px;"> Select "Control" or "No control" by keeping [RESET] button pushed for 20 seconds. ("No control" at shipment from the factory.) </div> <div style="border: 1px solid black; padding: 5px;"> Exchanging from "No control" to "Control" : Beep sound is heard (Pi, Pi, Pi, Pi, Pi) and the operation LED 5Hz flashes for 5 seconds. Exchanging from "Control" to "No control" : Beep sound is heard. (Operation LED does not flash.) </div> | <p>1. Purpose For the users who concern about noise of the outdoor unit, this control controls the max. revolutions of the compressor to reduce the noise.</p> <p>2. Description To reduce noise, [RESET] button of the indoor unit is kept pushed for 20 seconds. The number of revolution for the indoor fan motor and the set up temperature value are kept as they are.</p> <p>3. Operation As shown in the table, the maximum revolution number of indoor unit compressor can be reduced. As the maximum number of revolution of the compressor is restricted, the rise-up performance at the start time is weakened.</p> |

<Maximum number of revolution of compressor at normal time and Quiet control time>

| Model name | | RAS-25N4KVPG-ND | | RAS-35N4KVPG-ND | |
|------------|--------------------|-------------------|------------------------|-------------------|------------------------|
| Operation | Outside temp. (To) | Normal time (rps) | Quiet controlled (rps) | Normal time (rps) | Quiet controlled (rps) |
| Cool | - | 36 | 29 | 37 | 34 |
| Heat | - 5°C | 103 | 54 | 97 | 54 |
| | - 10 ~ - 5°C | 103 | 54 | 97 | 54 |
| | - 10°C | 103 | 54 | 97 | 54 |

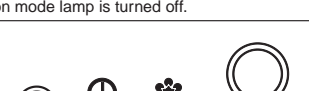
| | | |
|--------------------------------------|---|---|
| 24. Operation mode selectable | <p>Operating system setting</p> <div style="border: 1px solid black; padding: 10px; margin: 10px auto; width: fit-content;"> <p style="text-align: center;">WP-030</p>  </div> <ul style="list-style-type: none"> • Do cut J804 for cooling only system • Do cut J805 for heating only system • Do cut both of J804 and J805 for return to factory default. | <p>1. Purpose Choosing the operating system as appropriate in real condition</p> <p>2. Operation Factory default setting prefer "Heat pump" system. Through it is able to cooling only system heating only system or return to factory default.</p> |
|--------------------------------------|---|---|

| Item | Operation flow and applicable data,etc | Description | | | | | | |
|--|---|--|---------------|-------------|-----------------|-----|----------------------------|---|
| <p>25. Fireplace Operation</p> | <p>Fireplace button on remote controller is pressed.</p> <p>Fireplace 1: Cancel cold draft prevention control and fan speed depend on user require base on basic control.</p> <p>Fireplace 2: Cold draft prevention control is active with super low fan speed as show in the figure.</p> <table border="1" data-bbox="379 501 946 577"> <thead> <tr> <th>Model</th> <th>25N4KVPD-ND</th> <th>35N4KVPD-ND</th> </tr> </thead> <tbody> <tr> <td>Fan speed (RPM)</td> <td>640</td> <td>640</td> </tr> </tbody> </table> <p>Fireplace Operation</p>  | Model | 25N4KVPD-ND | 35N4KVPD-ND | Fan speed (RPM) | 640 | 640 | <p>Keep air circulation during other heat source applied.</p> <p>Note: With Fireplace operation on heating mode indoor unit always runs and cold air breezing might be occurred.</p> |
| Model | 25N4KVPD-ND | 35N4KVPD-ND | | | | | | |
| Fan speed (RPM) | 640 | 640 | | | | | | |
| <p>26. 8°C heating / Frost protective operation</p> | <p>8°C Button on remote controller is pressed. Set temperature is performed for 5°C to 13°C and no cold draft prevention control.</p> <p>8°C heating operation</p>  | <p>Intended for cold latitudes and performs objective heating operation.</p> | | | | | | |
| <p>27. Cord Heater Control</p> | <p>Base plate and outside cord heater control</p> <table border="1" data-bbox="408 1413 898 1702"> <thead> <tr> <th>TO temp.</th> <th>Heater output</th> </tr> </thead> <tbody> <tr> <td>2°C</td> <td>OFF</td> </tr> <tr> <td>0°C</td> <td>ON (Equivalent to 100W)</td> </tr> </tbody> </table> <p>When TO sensor is defective or the air conditioner is cooling operation, heater output is turned off.</p> | TO temp. | Heater output | 2°C | OFF | 0°C | ON (Equivalent to 100W) | <ol style="list-style-type: none"> Purpose Base plate freeze prevention of the outdoor unit. Operation As shown in the figure below, the base plate freeze preventive heater is controlled by temperature of the outside temperature sensor (TO). |
| TO temp. | Heater output | | | | | | | |
| 2°C | OFF | | | | | | | |
| 0°C | ON (Equivalent to 100W) | | | | | | | |

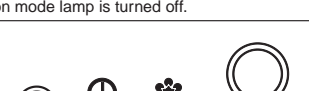
| Item | Operation flow and applicable data,etc | Description | | | | | | | | | | | | | | | |
|---|---|--------------------|-------------------|------------|-----------|--|------|-----------|---|-----|-----------|---|-----|-----------|--|----------------|---|
| <p>28. FCU Display lamp brightness control</p> | <div data-bbox="177 293 954 533" style="border: 1px solid black; padding: 10px; margin-bottom: 10px;"> <p style="text-align: center;">LAMP BRIGHTNESS ADJUSTMENT</p> <p>While operating (Auto, Cool, Heat or Dry), press and hold FAN 5 seconds.</p> <p>Press  Rise or  Decrease to adjust brightness which can be set at 4 levels or to turn it off.</p> </div> <table border="1" data-bbox="181 566 912 1189"> <thead> <tr> <th>Remote control LCD</th> <th>Operation display</th> <th>Brightness</th> </tr> </thead> <tbody> <tr> <td style="text-align: center;">d3</td> <td style="text-align: center;">  Lamp illuminates an operation with full brightness. </td> <td style="text-align: center;">100%</td> </tr> <tr> <td style="text-align: center;">d2</td> <td style="text-align: center;">  Lamp illuminates an operation with 50% brightness. </td> <td style="text-align: center;">50%</td> </tr> <tr> <td style="text-align: center;">d1</td> <td style="text-align: center;">  Lamp illuminates an operation with 50% brightness and the operation mode lamp is turned off. </td> <td style="text-align: center;">50%</td> </tr> <tr> <td style="text-align: center;">d0</td> <td style="text-align: center;">  All lamps are turned off. </td> <td style="text-align: center;">All turned off</td> </tr> </tbody> </table> <p>● In the examples of d1 and d0, the lamp illuminates for 5 seconds before going off.</p> | Remote control LCD | Operation display | Brightness | d3 |  Lamp illuminates an operation with full brightness. | 100% | d2 |  Lamp illuminates an operation with 50% brightness. | 50% | d1 |  Lamp illuminates an operation with 50% brightness and the operation mode lamp is turned off. | 50% | d0 |  All lamps are turned off. | All turned off | <p>1. Purpose It is necessary to decrease the display lamp brightness or turn it off.</p> |
| Remote control LCD | Operation display | Brightness | | | | | | | | | | | | | | | |
| d3 |  Lamp illuminates an operation with full brightness. | 100% | | | | | | | | | | | | | | | |
| d2 |  Lamp illuminates an operation with 50% brightness. | 50% | | | | | | | | | | | | | | | |
| d1 |  Lamp illuminates an operation with 50% brightness and the operation mode lamp is turned off. | 50% | | | | | | | | | | | | | | | |
| d0 |  All lamps are turned off. | All turned off | | | | | | | | | | | | | | | |

9-3. Auto Restart Function (Default setting from factory is ON).

This indoor unit is equipped with an automatic restarting function which allows the unit to restart operating with the set operating conditions in the event of a power supply being accidentally shut down. The operation will resume without warning three minutes after power is restored.

This function is set to work from the factory.

The Auto Restart Function will not restart operation of the air conditioner in following case.

- The Auto Restart Function is setup to OFF.
- The power supply is shut down during the air conditioner is OFF.
- The power supply is shut down when timer operatio is set.

9-3-1. How to Cancel the Auto Restart Function

To cancel Auto Restart Function, proceed as follows.

1. The power supply to the unit must be ON ; The function will not set or reset if the power supply is OFF.
2. Press the [RESET] button located on the front panel of the indoor unit for more than 3 seconds.
3. After 3 seconds, the unit beeps three times.

• When the system is on stand-by (not operating)

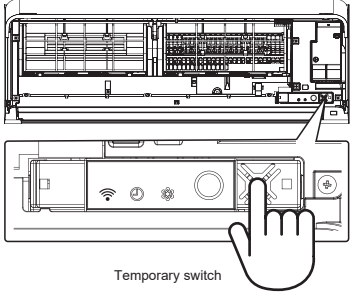
| Operation | Motions |
|--|--|
| <p>Press [RESET] button for more than three seconds. (Less than 10 seconds)</p>  <p>Temporary switch</p> | <p>The unit is on standby.</p> <p>↓</p> <p>The unit starts to operate. The blue indicator is on.</p> <p>↓ After approx. three seconds,</p> <p>The unit beeps three times and continues to operate.</p> <p>If the unit is not required to operate at this time, press [RESET] button once more or use the remote controller to turn it off.</p> |

• When the system is operating

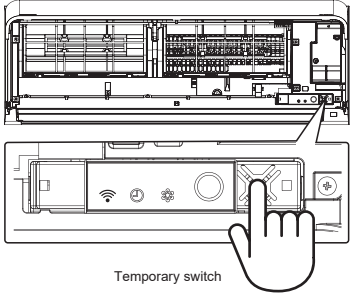
| Operation | Motions |
|---|---|
| <p>Press [RESET] button for more than three seconds. (Less than 10 seconds)</p>  <p>Temporary switch</p> | <p>The unit is in operation. The blue indicator is on.</p> <p>↓</p> <p>The unit stops operating. The blue indicator is turned off.</p> <p>↓ After approx. three seconds,</p> <p>The unit beeps three times.</p> <p>If the unit is required to operate at this time, press [RESET] button once more or use the remote controller to turn it on.</p> |

9-3-2. How to Set the Auto Restart Function

To set Auto Restart Function, proceed as follows:

1. The power supply to the unit must be ON ; The function will not set or reset if the power supply is OFF.
2. Press the [RESET] button located on the front panel of the indoor unit for more than 3 seconds.
3. After 3 seconds, the unit beeps three times and the indicator blinks for 5 seconds.

• When the unit is standby (Not operating)

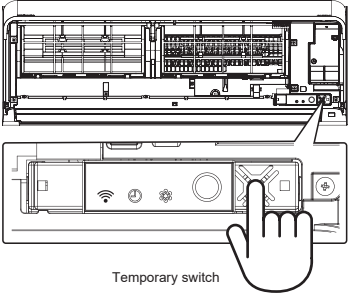
| Operation | Motions |
|---|--|
| <p>Press [RESET] button for more than three seconds. (Less than 10 seconds)</p>  <p>Temporary switch</p> | <p>The unit is on standby. ↓ The unit starts to operate. The blue indicator is on. ↓ After approx. three seconds, The unit beeps three times The blue indicator flashes and continues to operate. for 5 seconds.</p> <p>If the unit is not required to operate at this time, press [RESET] button once more or use the remote controller to turn it off.</p> |

• When the unit is in operation

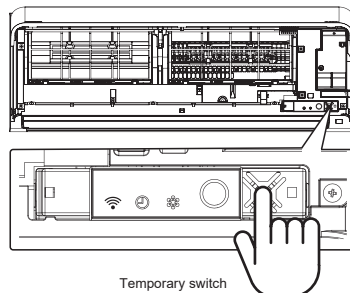





















| Operation | Motions |
|---|---|
| <p>Press [RESET] button for more than three seconds. (Less than 10 seconds)</p>  <p>Temporary switch</p> | <p>The unit is in operation. The blue indicator is on. ↓ The unit stops operating. The blue indicator is turned off. ↓ After approx. three seconds, The unit beeps three times. The blue indicator flashes for 5 seconds.</p> <p>If the unit is required to operate at this time, press [RESET] button once more or use the remote controller to turn it on.</p> |

9-3-3. Power Failure During Timer Operation

- If Timer operation is set and the power supply shut down accidentally, the previous Timer setting will be cancelled.
- Weekly-timer operation will be not affected by power supply failure, if the remote controller is located on the position which it can send the command signal to the indoor unit. It is because the remote controller will send signal when real clock reach to program setting.

9-4. Remote control

9-4-1. Remote control and its functions

- ① Infrared signal emitter
- ② Memory and preset button (PRESET)
- ③ Start/Stop button ()
- ④ Temperature up/down button ()
- ⑤ Mode select button ()
- ⑥ Swing louver button ()
- ⑦ Fan speed button ()
- ⑧ Wide air flow, spot air flow ()
- ⑨ Set louver button for vertical direction ()
- ⑩ Set louver button for Horizontal direction ()
- ⑪ 8 degree Celsius operation and fireplace function button ()
- ⑫ Economy button ()
- ⑬ High power button ()
- ⑭ Plasma ionizer purifier button ()
- ⑮ Comfort sleep button ()
- ⑯ Power selection and silent operation button ()
- ⑰ On timer button ()
- ⑱ Off timer button ()
- ⑲ Setup button ()
- ⑳ Clear button ()
- ㉑ Clock setup button (CLOCK)
- ㉒ Check button (CHECK)
- ㉓ Filter reset button (FILTER)
- ㉔ Reset button (RESET)
- ㉕ Weekly ON/OFF button ()
- ㉖ Day button ()
- ㉗ Temp for weekly timer button ()
- ㉘ Program P1-P4 button ()

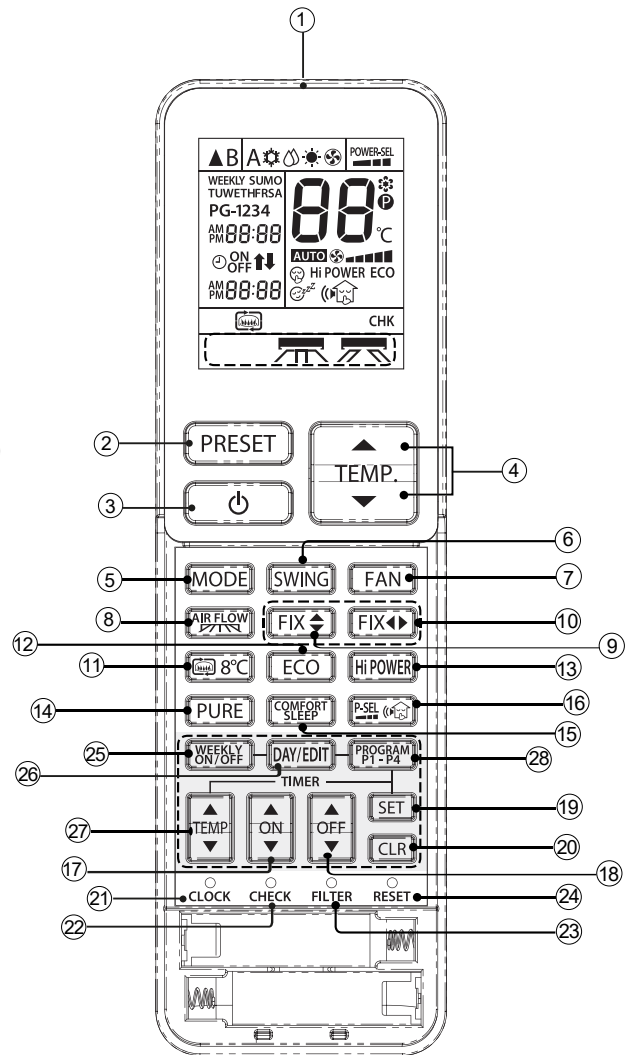

9-4-2. Operation of remote control

1. Weekly timer operation

4 programs for each day in the week can be set in WEEKLY TIMER.

The following items can be set in WEEKLY TIMER operation.

- a. Operation time (ON timer for Start and OFF timer for Stop operation)
- b. Operation mode (AUTO, COOL, DRY, HEAT, FAN ONLY)
- c. Temperature setting.
- d. Fan speed setting.
- e. Special operation (8°C, ECO, Hi-POWER, SILENT)

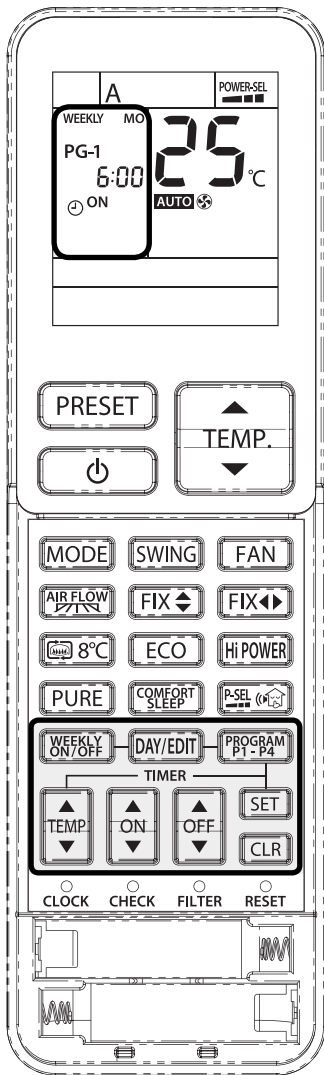

How to set WEEKLY TIMER

1 Press **DAY/EDIT** to enter WEEKLY TIMER setting.

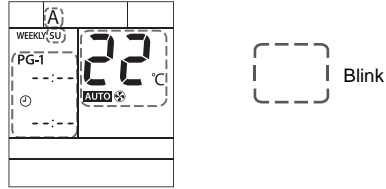

2 Press **DAY/EDIT** to select desired day in sequence.
The sequence of day symbol appears on the LCD

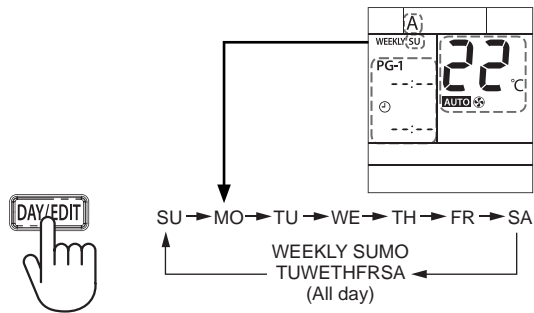

3 Press **PROGRAM P1-P4** to select the program number.

- The program 1 is ready for setting while **DAY/EDIT** is pressed PG-1 appears on the LCD.
- Press **PROGRAM P1-P4** to change the program number in the sequence program 1 to program 4.

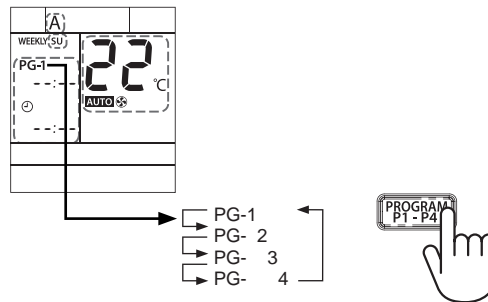

4 Press **ON** or **OFF** to select the desired time.

- The time can be set between 0:00 and 23:50 in 10 minute intervals.
- Press and hold the button to change setting time for 1 hr.
- Only one of ON or OFF timer can be set on each program.

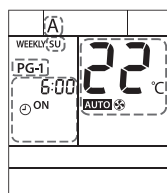

ON timer display

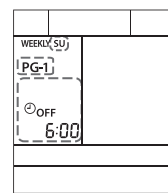

OFF timer display*

*OFF timer is used to stop the air conditioner only. The display does not show Operation mode, Temperature, Fan speed and others.

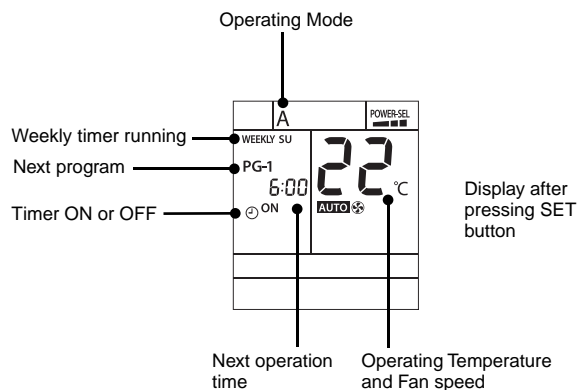
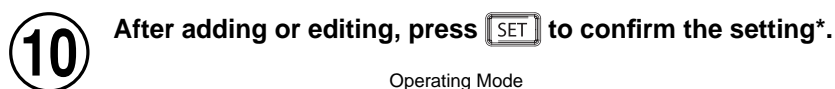
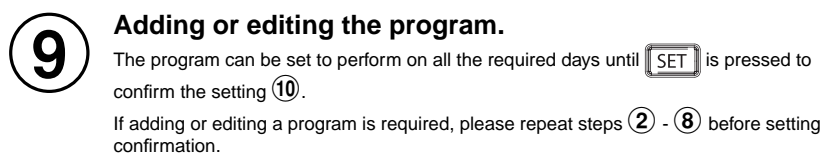
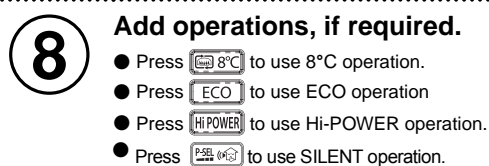
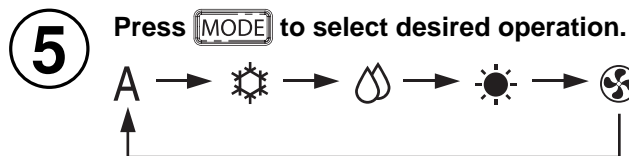

*Point remote control at air conditioner receiving module then, press SET button until you hear the "PiPi" sound. This means the setting operation has been completed. As the air conditioner is receiving the signal, you will hear separate "Pi" sounds corresponding to the number of days in the selected setting. An incomplete setting is indicated if the TIMER lamp is blinking. Press **WEEKLY ON/OFF** twice.

Notes

1. Place the remote control where the indoor unit can receive the signal. This will increase the accuracy of the timing between the remote control and the air conditioning unit.
2. The ON/OFF timer can be set during the WEEKLY TIMER operation. In this situation, the air conditioner will first follow the normal timer until it is complete; then, it will return to the WEEKLY TIMER function.
3. During WEEKLY TIMER operation, all of operation such as MODE, TEMP, FAN, Hi-POWER, ECO and etc., can be adjusted but when the clock reaches the program setting, the operation will return to the set items in the program.
4. When the remote control is sending a signal to the air conditioner, avoid interference from objects that can block the signal.

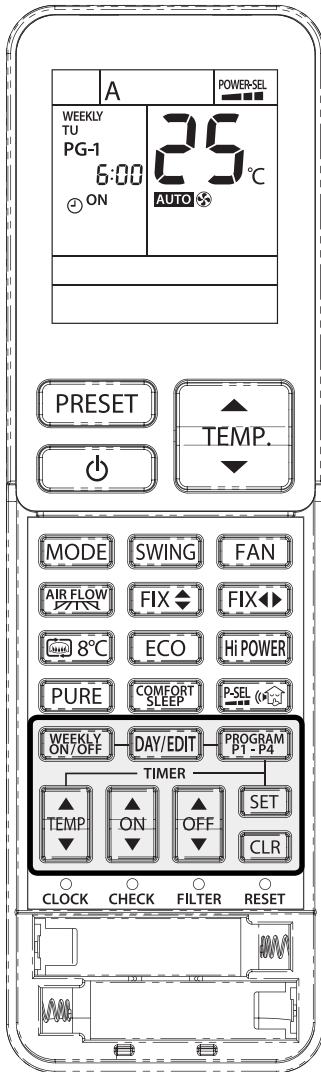

Edit Weekly timer program

To edit the program after confirming the weekly timer setting on [Page 54](#), follow steps ① - ③ below.

- ① Press **DAY/EDIT**.
 - The day of the week and the program number of the current day will be displayed.

- ② Press **DAY/EDIT** to select the day of the week and press **PROGRAM P1-P4** to select program number to be confirmed.
 - Resetting the operation.

- ③ Press **SET** to exit confirming mode.

Deactivating WEEKLY TIMER operation

Press **WEEKLY ON/OFF** while "WEEKLY" is displayed on the LCD.

- The "WEEKLY" indicator will disappear from the LCD. However, the program will remain in the remote control.
- The TIMER lamp goes off.
- To reactivate the WEEKLY TIMER operation again, press **WEEKLY ON/OFF** again, LCD shows the next program. The program, after reactivation, is related to the clock time.

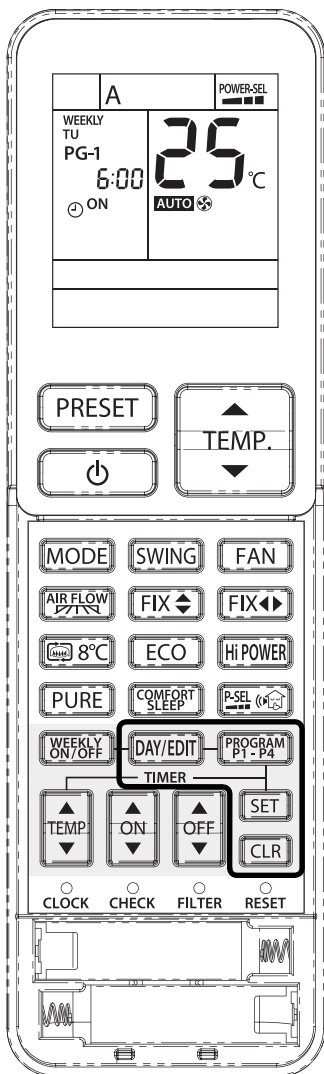

To delete programs

The individual program

- 1** Press **DAY/EDIT**.
 - The day of the week and the program number is displayed.
 - Select the day to delete the program.

- 2** Press **PROGRAM P1-P4** to select the program number to be deleted.

- 3** Press **CLR**.
 - ON or OFF timer will be cleared and the LCD will blink.

- 4** Press **SET** to delete the program.
 - Press **SET** while the LCD is blinking. The program has now been deleted.

All programs

- 1** Press **DAY/EDIT**.
 - The day of the week and the program number will be displayed.

- 2** Press **CLR** and hold for 3 seconds.
 - All programs will be deleted and LCD displays current operation.

Notes

Make sure the remote control receiving module on the air conditioner receives the signal from the remote control.

2. AUTOMATIC OPERATION

To automatically select cooling or fan only operation.

1. Press **MODE** : Select Auto A.
2. Press **TEMP.** : Select the desired temperature, Min : 17°C, Max : 30°C
3. Press **FAN** : Select AUTO, LOW \leftarrow , LOW+ $\leftarrow\leftarrow$, MED $\leftarrow\leftarrow\leftarrow$, MED+ $\leftarrow\leftarrow\leftarrow\leftarrow$, HIGH $\leftarrow\leftarrow\leftarrow\leftarrow\leftarrow$ or Quiet 

3. FIREPLACE and 8°C OPERATION

1. Press **8°C** button to change Fireplace1, Fireplace2 and 8°C operation
2. Press **TEMP.** to adjust setting temperature from 5°C to 13°C



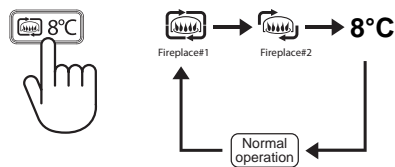

Note1 : 8°C will operate in Heating mode only. should be change mode to Heating mode before use.

Note2 : With Fireplace operation on heating mode indoor unit always runs and cold air breezing might be occurred.

FIREPLACE and 8°C operation.



4. COOLING / HEATING / FAN ONLY OPERATION

1. Press **MODE** : Select Cool , Heat , or Fan only 
2. Press **TEMP.** : Set the desired temperature
Cooling: Min. 17°C, Heating : Max, 30°C, Fan Only: No temperature indication
3. Press **FAN** : Select AUTO, LOW \leftarrow , LOW+ $\leftarrow\leftarrow$, MED $\leftarrow\leftarrow\leftarrow$, MED+ $\leftarrow\leftarrow\leftarrow\leftarrow$ HIGH $\leftarrow\leftarrow\leftarrow\leftarrow\leftarrow$ or Quiet 

Note : QUIET is ultra low fan speed for quiet operation.

5. DRY OPERATION (COOLING ONLY)

For dehumidification, a moderate cooling performance is controlled automatically.

1. Press **MODE** : Select Dry 
2. Press **TEMP.** : Set the desired temperature.

Note : DRY mode fan speed is set to Auto only.

6. PLASMA IONIZER PURIFIER OPERATION

During air conditioner operation

Press **PURE** PURE to start and plasma ionizer purifier operation.

The plasma air purifier and plasma ionizer purifier can be activated or deactivated during air conditioner is stopped and the plasma ionizer purifier starts in conjunction with plasma plasma ionizer purifier operation.

7. Hi-POWER OPERATION

To automatically control room temperature and airflow for faster cooling or heating operation (except in DRY and FAN ONLY mode)

Press **HiPOWER** : Start and stop the operation

8. ECO OPERATION

To automatically control room to save energy (except in DRY and FAN ONLY mode)

Press **ECO** : Start and stop the operation.

Note: Cooling operation; the set temperature will increase automatically 1 degree/ hour for 2 hours (maximum 2 degrees increase). For heating operation the set temperature will decrease.

9. AIR VOLUME, AIR DIRECTION AND SWING LOUVERS

- Changing the air volume, press FAN button

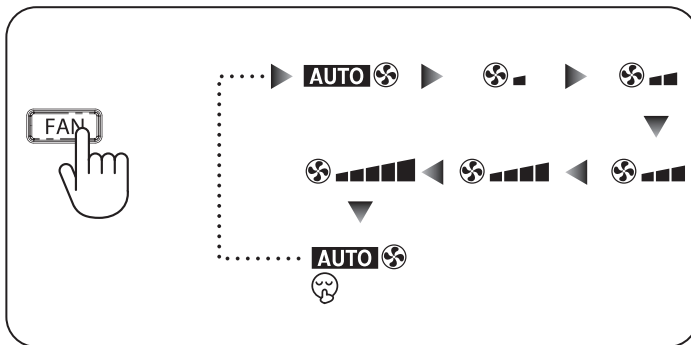

- Changing the air direction, press FIX button

When changing the air to the vertical direction, release the left side at the desired position.
(**BeepBeep** at the lower and upper limit).

When changing the air to the horizontal position, release the right side at the desired position.
(**BeepBeep** sounds at the center position).

- Changing the air direction, press FIX button

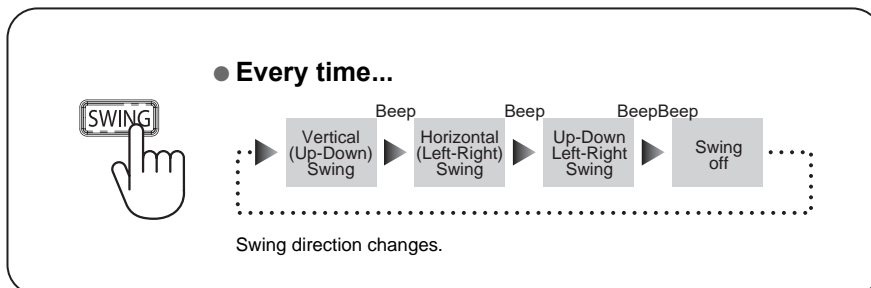

- Movement of vertical air direction louvers

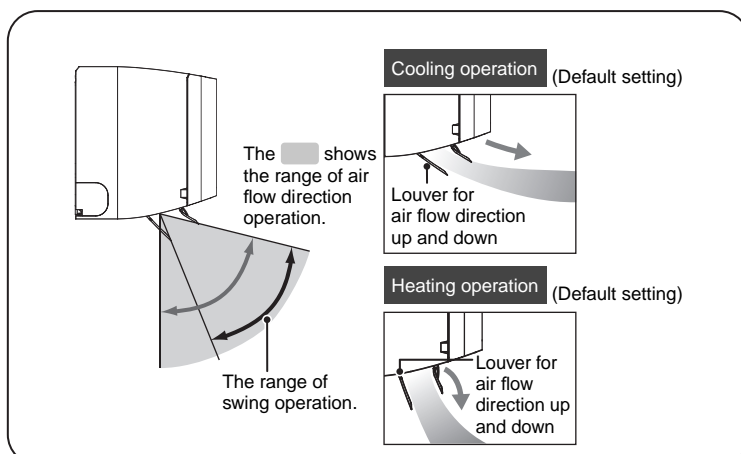

10. COMFORT AIR FLOW

- Wide air flow : Air flows around the room.
- Spot air flow : Air flow is concentrated at one point.

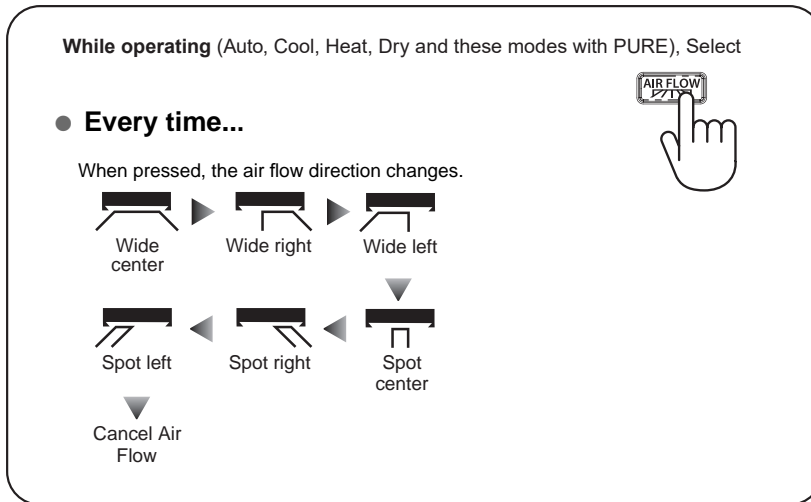

11. TIMER OPERATION

| | Setting the ON Timer | Setting the OFF Timer |
|---|---|--|
| 1 | Press ON for enter ON timer setting | Press OFF for enter OFF timer setting |
| 2 | Press TEMP. for select desired ON timer. | Press TEMP. for select desired OFF timer. |
| 3 | Press SET for set timer. | Press SET for set timer. |
| 4 | Press CLR for cancel timer. | Press CLR for cancel timer. |

Note:

- Keep the remote control in accessible transmission to the indoor unit otherwise, the time lag of up to 15 minutes will occur.
- The setting will be saved for the next same operation

12. PRESET OPERATION

Set your preferred operation for future use. The setting will be memorized by the unit for future operation (except air flow direction).

1. Select your preferred operation.
2. Press and hold **PRESET** for 3 seconds to memorize the setting. The **Ⓟ** mark displays.
3. Press **PRESET** : Operate the preset operation.

13. QUIET OPERATION

To operate at ultra low fan speed for quiet operation (except in DRY mode)

Press ● [Fan] Button : Start and stop the operation.

Note: Under certain conditions, QUIET operation may not provide adequate cooling or heating due to low sound features.

14. POWER-SELECTION OPERATION / SILENT OPERATION

Press  button to select Power-SEL, Silent 1 and Silent 2

POWER-SELECTION AND SILENT OPERATION

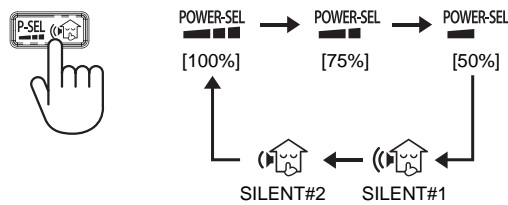

Note1 : When the level is selected, PWR-SEL level flashes on remote LCD display for 3 seconds
In case of 75% and 50% level, number “75” or “50” also flashes for 2 seconds.

Note2 : Due to the reason that POWER SELECTION FUNCTION and silent operation, inadequate cooling or heating capacity may occur.

15. COMFORT SLEEP OPERATION

To save energy while sleeping, automatically control air flow and automatically turn OFF.

Press  : Select 1, 3, 5 or 9 hrs for OFF timer operation.

Note: The cooling operation, the set temperature will increase automatically 1 degree/hour for 2 hours (maximum 2 degrees increase). For heating operation, the set temperature will decrease.

9-4-3. Name and Functions of Indications on Remote Controller





[Display]

All indications, except for the clock time indicator, are displayed by pressing the  button.

1 Transmission mark

This transmission mark  indicates when the remote controller transmits signals to the indoor unit.

2 Mode indicator

Indicates the current operation mode.
(A : Auto,  : Cool,  : Dry,  : Heat,  : FAN ONLY)





3 Temperature indicator

Indicates the temperature setting.
(17°C to 30°C)

4 Plasma indicator

Shows that the electrical plasma purifying operation is in progress.

5 FAN speed indicator

Indicates the selected fan speed.
AUTO or five fan speed levels
(LOW , LOW+ , MED , MED+ , HIGH , QUIET) can be shown.

6 TIMER and weekly timer indicator

The time setting for timer operation and weekly timer function is indicated.

The current time is always indicated except during TIMER operation.

7 Hi-POWER indicator

Indicates when the Hi-POWER operation starts.
Press the Hi-POWER button to start and press it again to stop the operation.



8 P (PRESET) indicator

Flashes for 3 seconds when the PRESET button is pressed during operation.

The  mark is shown when holding down the button for more than 3 seconds while the mark is flashing.

Press another button to turn off the mark.

9 POWER-SEL

Indicates the selected POWER-SEL level.
( 100%,  75%,  50%)

10 A, B change indicator remote controller

When the remote controller switching function is set, "B" appears in the remote controller display.
(When the remote controller setting is "A", there is no indication at this position.)

11 Comfort sleep

Indicates when comfort sleep is activated.
Press comfort sleep button to select function.

12 Quiet

Indicates when quiet is activated.
Press Fan button to start and press it again to select other fan speed for operation.

13 Comfort Air flow

Indicates Air flow direction

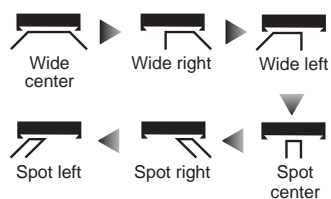

14 ECO indicator

Indicates when the ECO is in activated.
Press the ECO button to start and press it again to stop operation.

15 Silent operation

Indicates the selected Silent 1 and Silent 2.

16 Fireplace operation

Indicates the selected Fireplace 1 and Fireplace 2.

17 Service Mode indicator

Shows during enter service Mode.

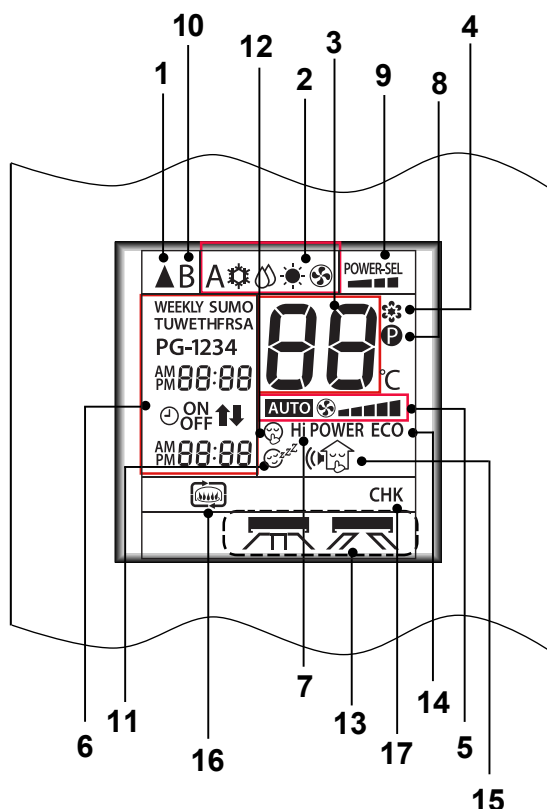

10. INSTALLATION PROCEDURE

10-1. Installation Diagram of Indoor and Outdoor Units

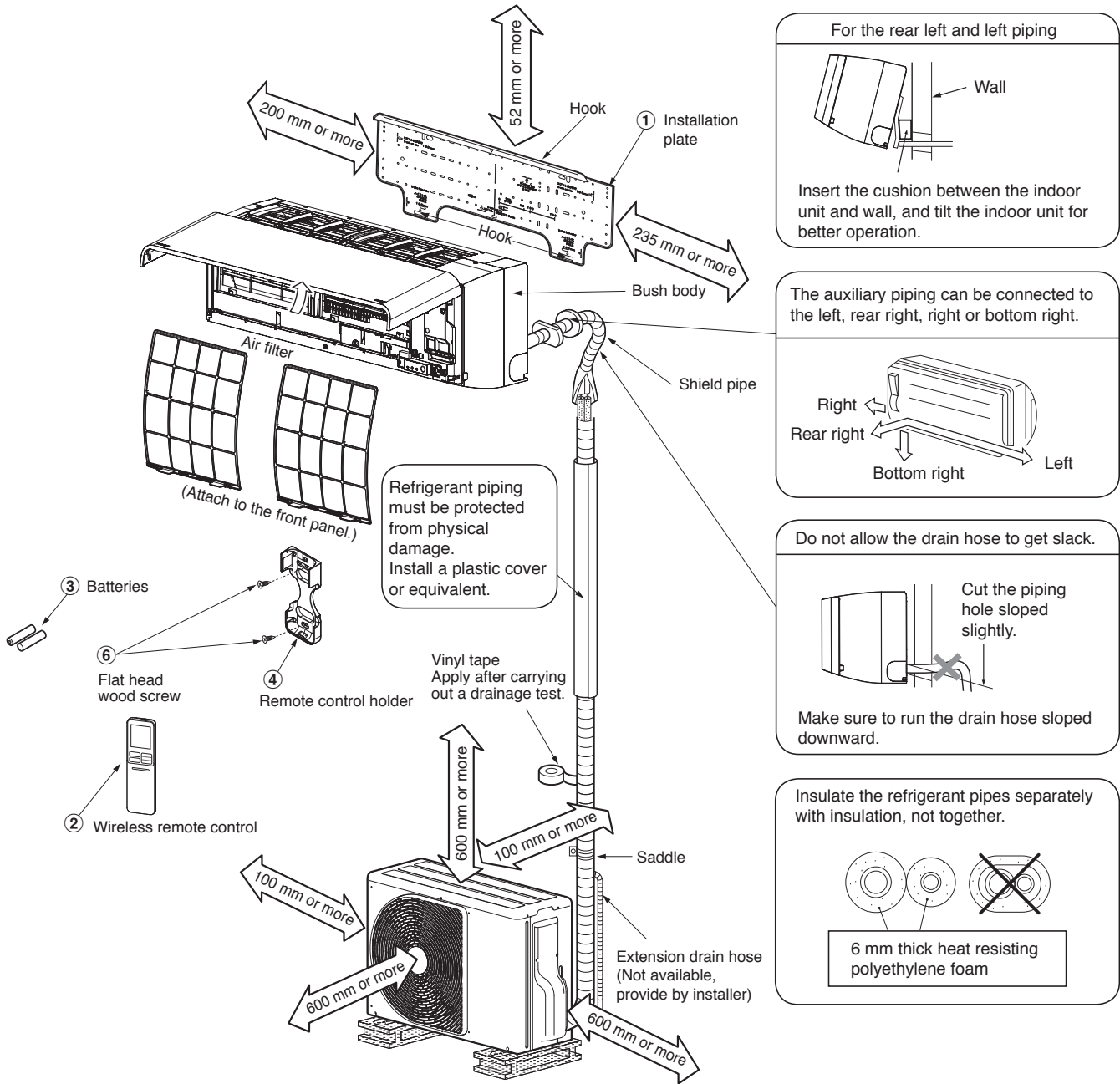

10-2. Installation

10-2-1. Optional installation parts

| Part Code | Parts name | Q'ty |
|-----------|---|----------|
| A | Refrigerant piping Liquid side : $\varnothing 6.35$ mm Gas side : $\varnothing 9.52$ mm | One each |
| B | Pipe insulating material (polyethylene foam, 6 mm thick) | 1 |
| C | Putty, PVC tapes | One each |

Fixing bolt arrangement of outdoor unit

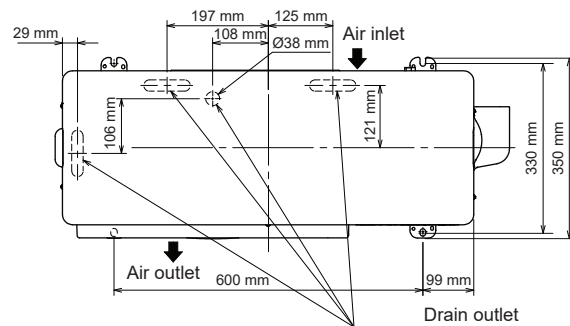







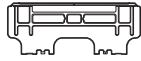

* Drain nipple and cap water proof are packed in outdoor unit.

Fig. 10-2-1

- Secure the outdoor unit with fixing bolts and nuts if the unit is likely to be exposed to a strong wind.
- Use $\varnothing 8$ mm or $\varnothing 10$ mm anchor bolts and nuts.
- If it is necessary to drain the defrost water, attach drain nipple ⑨ and cap water proof ⑩ to the bottom plate of the outdoor unit before installing it.

10-2-2. Accessory and installation parts

| Indoor Unit | | | |
|-------------|---|-----|--|
| No. | Parts name | No. | Parts name |
| ① |  Installation plate × 1 | ② |  Wireless remote control × 1 |
| ③ |  Battery × 2 | ④ |  Remote control holder × 1 |
| ⑤ |  Mounting screw × 6 | ⑥ |  Flat head wood screw × 2 |
| ⑦ |  Owner's Manual × 1 | ⑧ |  Installation Manual × 1 |

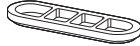
| Outdoor Unit | | | |
|--------------|--|-----|---|
| No. | Parts name | No. | Parts name |
| ⑨ |  Drain nipple × 1 | ⑩ |  Cap water proof × 3 |

Air filters

Clean every 2 weeks.

1. Open the air inlet grille.
2. Remove the air filters.
3. Vacuum or wash and then dry them.
4. Reinstall the air filters and close the air inlet grille.

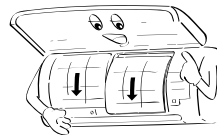







10-2-3. Installation/Serviceing Tools

Changes in the product and components

In the case of an air conditioner using R32, in order to prevent any other refrigerant from being charged accidentally, the service port diameter of the outdoor unit control valve (3 way valve) has been changed. (1/2 UNF 20 threads per inch)

- In order to increase the pressure resisting strength of the refrigerant piping flare processing diameter and size of opposite side of flare nuts has been changed. (for copper pipes with nominal dimensions 1/2 and 5/8)

New tools for R32(R410A)

| New tools for R32(R410a) | Applicable to R22 model | | Changes |
|---|-------------------------|---|---|
| Gauge manifold | ✗ |  | As pressure is high, it is impossible to measure by means of conventional gauge. In order to prevent any other refrigerant from being charged, each port diameter has been changed. |
| Charge hose | ✗ |  | In order to increase pressure resisting strength, hose materials and port size have been changed (to 1/2 UNF 20 threads per inch). When purchasing a charge hose, be sure to confirm the port size. |
| Electronic balance for refrigerant charging | ○ |  | As pressure is high and gasification speed is fast, it is difficult to read the indicated value by means of charging cylinder, as air bubbles occur. |
| Torque wrench (nominal diam. 1/2, 5/8) | ✗ |  | The size of opposite sides of flare nuts have been increased. Incidentally, a common wrench is used for nominal diameters 1/4 and 3/8. |
| Flare tool (clutch type) | ○ |  | By increasing the clamp bar's receiving hole, strength of spring in the tool has been improved. |
| Gauge for projection adjustment | — | — | Used when flare is made by using conventional flare tool. |
| Vacuum pump adapter | ○ |  | Connected to conventional vacuum pump. It is necessary to use an adapter to prevent vacuum pump oil from flowing back to the charge hose. The charge hose connecting part has two ports-one for conventional refrigerant (7/16 UNF 20 threads per inch) and one for R32(R410a). If the vacuum pump oil (mineral) mixes with R32(R410a) a sludge may occur and damage the equipment. |
| Gas leakage detector | ✗ |  | Exclusive for HFC refrigerant. |

- Incidentally, the “refrigerant cylinder” comes with the refrigerant designation R32(R410a) and protector coating in the U.S's ARI specified rose color (ARI color code: PMS 507).
- Also, the “charge port and packing for refrigerant cylinder” require 1/2 UNF 20 threads per inch corresponding to the charge hose's port size.

10-3. Indoor Unit

10-3-1. Installation Place

- A place which provides the spaces around the indoor unit as shown in the diagram.
- A place where there are no obstacle near the air inlet and outlet.
- A place which allows easy installation of the piping to the outdoor unit.
- A place which allows the front panel to be opened.
- The indoor unit shall be installed at least 2.5 m height. Also, it must be avoided to put anything on the top of the indoor unit.

CAUTION

- Direct sunlight on the indoor unit wireless receiver should be avoided.
- The microprocessor in the indoor unit should not be too close to RF noise sources. (For details, see the owner's manual.)

Remote control

- A place where there are no obstacles such as a curtain that may block the signal from the indoor unit
- Do not install the remote control in a place exposed to direct sunlight or close to a heating source such as a stove.
- Keep the remote control at least 1 m apart from the nearest TV set or stereo equipment. (This is necessary to prevent image disturbances or noise interference.)
- The location of the remote control should be determined as shown below.

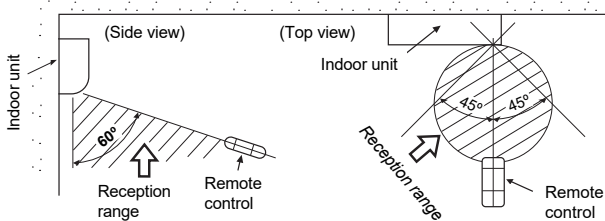

Fig. 10-3-1

10-3-2. Cutting a Hole and Mounting Installation Plate

Cutting a hole

When installing the refrigerant pipes from the rear.

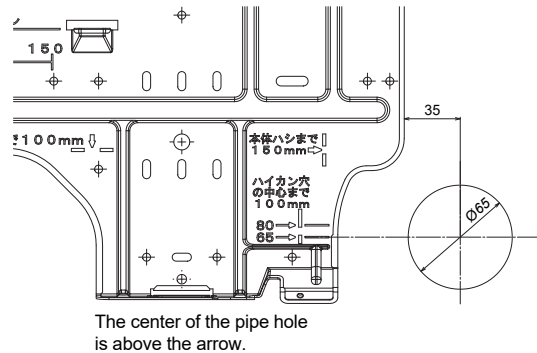

Fig. 10-3-2

1. After determining the pipe hole position on the installation plate (⇔) drill the pipe hole (Ø65 mm) at a slight downward slant to the outdoor side.

NOTE :

- When drilling into a wall that contains a metal lath, wire lath or metal plate, be sure to use a pipe hole brim ring sold separately.

Mounting the installation plate

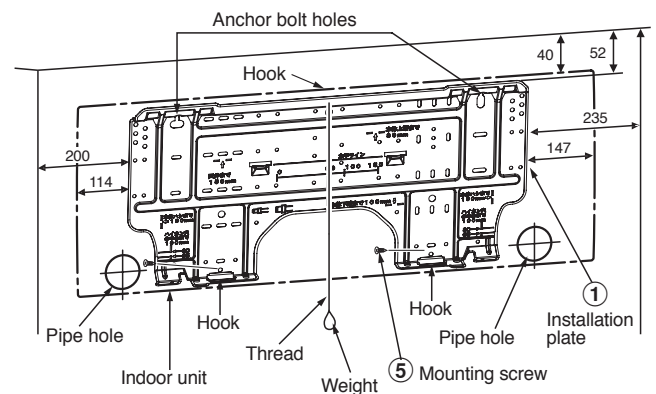

Fig. 10-3-3

When the installation plate is directly mounted on the wall

1. Securely fit the installation plate onto the wall by screwing it in the upper and lower parts to hook up the indoor unit.
2. To mount the installation plate on a concrete wall with anchor bolts, use the anchor bolt holes as illustrated in the below figure.
3. Install the installation plate horizontally in the wall.

CAUTION

When installing the installation plate with a mounting screw, do not use the anchor bolt holes. Otherwise the unit may fall down and result in personal injury and property damage.

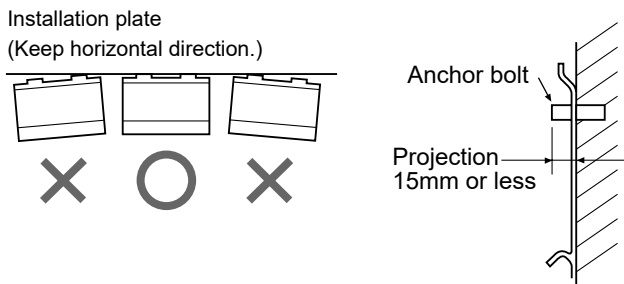

Fig. 10-3-4

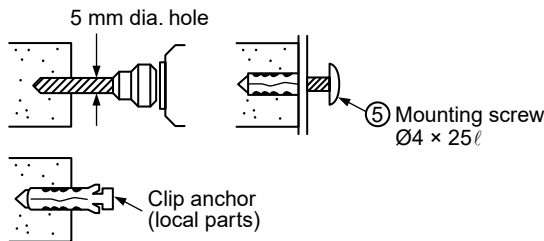

Fig. 10-3-5

CAUTION

Failure to firmly install the unit may result in personal injury and/or property damage if the unit falls.

- In case of block, brick, concrete or similar type walls, make 5 mm dia. holes in the wall.
- Insert clip anchors for appropriate mounting screws ⑤.

NOTE :

- Secure four corners and lower parts of the installation plate with 4 to 6 mounting screws to install it.

10-3-3. Piping and Drain Hose Installation
Piping and drain hose forming

- Since condensation results in machine trouble, make sure to insulate both the connecting pipes separately.
(Use polyethylene foam as insulating material.)

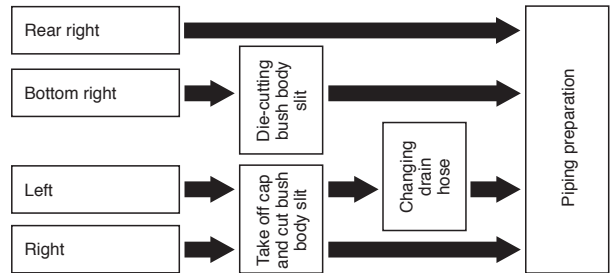

Fig. 10-3-6

1. Die-cutting bush body slit

- **For Bottom right**
Cut out the slit on bottom right side of bush body for bottom right connection with a pair of nippers.
- **For Left or Right**
Take off Cap and cut out the slit on left or right side of bush body for the left or right connection with a pair of nippers.

2. Changing drain hose

For leftward connection's piping, it is necessary to change the drain hose and drain cap.

How to remove the drain hose

- The drain hose can be removed by removing the screw securing the drain hose and then pulling out the drain hose.
- When removing the drain hose, be careful of any sharp edges of steel plate. The edges can injure.
- To install the drain hose, insert the drain hose firmly until the connection part contacts with heat insulator, and then secure it with original screw.

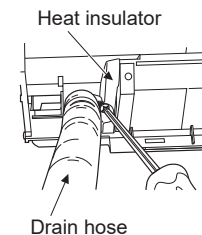

Fig. 10-3-7

How to remove the drain cap

Clip the drain cap by needle-nose pliers and pull out.

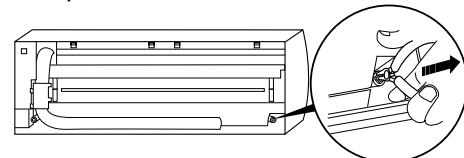

Fig. 10-3-8

How to fix the drain cap

1. Insert hexagonal wrench (4 mm) in a center head.

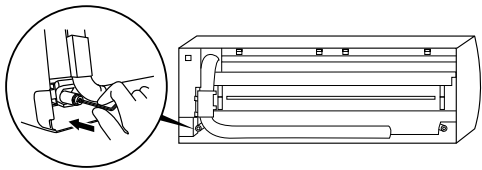

Fig. 10-3-9

- 2) Firmly insert the drain cap.

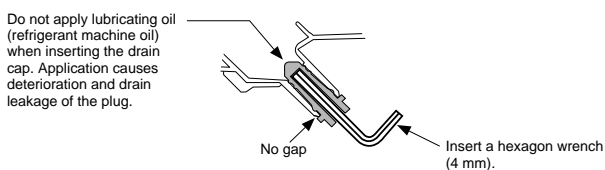

Fig. 10-3-10

CAUTION

Firmly insert the drain hose and drain cap; otherwise, water may leak.

In case of right or left piping

- Take off the cap by hand and cut of the slit.
- After scribing slits of the bush body with a knife or a making-off, cut them with a pair of nippers or an equivalent tool.

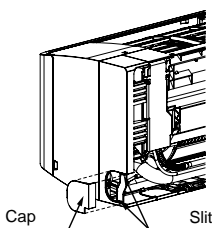

Fig. 10-3-11

In case of bottom right or bottom left piping

- After scribing slits of the bush body with a knife or a making-off pin, cut them with a pair of nippers or an equivalent tool.

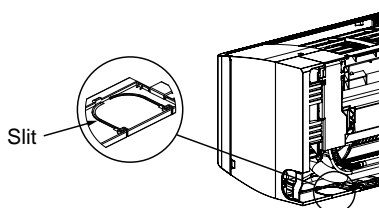

Fig. 10-3-12

Left-hand connection with piping

Bend the connecting pipe so that it is laid within 43 mm above the wall surface.

If the connecting pipe is laid exceeding 43 mm above the wall surface, the indoor unit may unstably be set on the wall.

When bending the connecting pipe, make sure to use a spring bender so as not crush the pipe.

Bend the connecting pipe within a radius of 30 mm.

To connect the pipe after installation of the unit (figure) Reference position of Liquid side and Gas side's piping on Installation Plate.

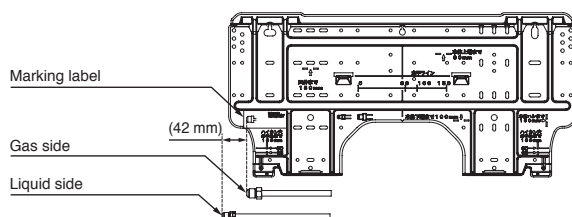
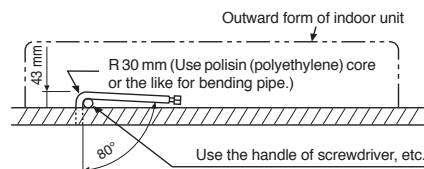

Fig. 10-3-13



NOTE :

If the pipe is incorrectly, the indoor unit may unstably be set on the wall.

After passing the connecting pipe through the pipe hole, connect the connecting pipes to the auxiliary pipes and wrap the facing tape around them.

CAUTION

- Bind the auxiliary pipes (two) and connecting cable with facing tape tightly. In case of leftward piping and rear-leftward piping, bind the auxiliary pipes (two) only with facing tape.

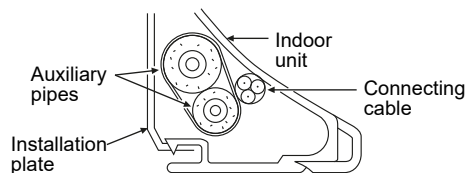

- Carefully arrange pipes so that any pipe does not stick out of the rear plate of the indoor unit. Carefully
- connect the auxiliary pipes and connecting pipes to one another and cut off the insulating tape wound on the connecting pipe to avoid double-taping at the joint; moreover, seal the joint with the vinyl tape, etc.
- Since dewing results in a machine trouble, make sure to insulate both connecting pipes. (Use polyethylene foam as insulating material.)
- When bending a pipe, carefully do it, not to crush it.

10-3-4. Indoor Unit Fixing

1. Pass the pipe through the hole in the wall and hook the indoor unit on the installation plate at the upper hook.
2. Swing the indoor unit to right and left to confirm that it is firmly hooked up on the installation plate.
3. While pressing the indoor unit onto the wall, hook it at the lower part on the installation plate. Pull the indoor unit toward you to confirm that it is firmly hooked up on the installation plate.



- For detaching the indoor unit from the installation plate, pull the indoor unit toward you while pushing its bottom up at the specified parts.

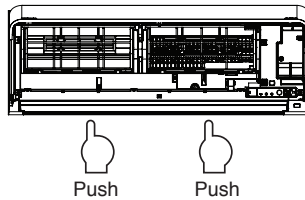

Fig. 10-3-14

10-3-5. In case of Indoor unit is fixed to Installation plate with screws

1. Remove 2 screw caps with flat screwdriver.
2. Fix them with $\varnothing 4 \times 10 \sim 14L$, 2 screws which are prepared at the site.
3. Cover screw caps as previous process.

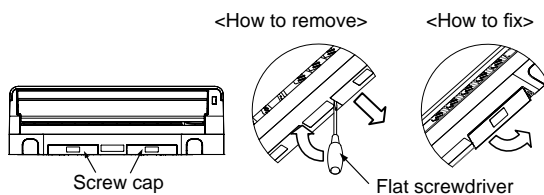

Fig. 10-3-15

10-3-6. Drainage

1. Run the drain hose sloped downwards.

NOTE :

- The hole should be made a slight downward slant on the outdoor side.

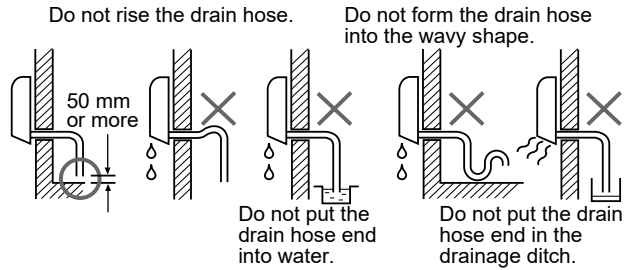

Fig. 10-3-16

2. Put water in the drain pan and make sure that the water is drained out of doors.
3. When connecting extension drain hose, insulate the connecting part of extension drain hose with shield pipe.

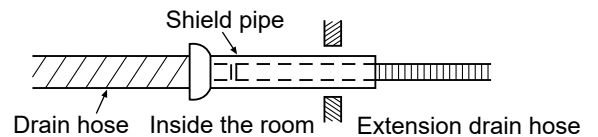

Fig. 10-3-17

CAUTION

Arrange the drain pipe for proper drainage from the unit. Improper drainage can result in dew-dropping.

This air conditioner has the structure designed to drain water collected from dew, which forms on the back of the indoor unit, to the drain pan. Therefore, do not store the power cord and other parts at a height above the drain guide.

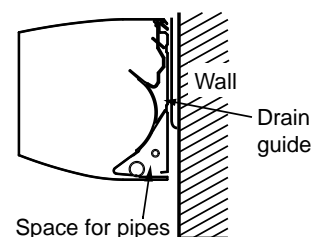

Fig. 10-3-18

10-4. Outdoor Unit

10-4-1. Installation place

- A place which provides the spaces around the outdoor unit as shown in the diagram
- A place which can bear the weight of the outdoor unit and does not allow an increase in noise level and vibration
- A place where the operation noise and discharged air do not disturb your neighbors
- A place which is not exposed to a strong wind
- A place free of a leakage of combustible gases
- A place which does not block a passage
- When the outdoor unit is to be installed in an elevated position, be sure to secure its feet.
- The allowable length of the connecting pipe.

| Model | RAS-25N4AVPG-ND | RAS-35N4AVPG-ND |
|---------------------------------|---------------------------|---------------------------|
| Chargeless | Up to 15 m | Up to 15 m |
| Maximum length | 25 m | 25 m |
| Additional refrigerant charging | 16 - 25 m (20 g / 1 m) | 16 - 25 m (20 g / 1 m) |
| Maximum refrigerant charging | 1.30 kg | 1.30 kg |

- The allowable height of outdoor unit installation site.

| Model | RAS-25N4AVPG-ND | RAS-35N4AVPG-ND |
|----------------|-----------------|-----------------|
| Maximum height | 15 m | 15 m |

- A place where the drain water does not raise any problems

Precautions for adding refrigerant

- Use a scale having a precision with at least 10 g per index line when adding the refrigerant.
Do not use a bathroom scale or similar instrument.

CAUTION

When the outdoor unit is installed in a place where the drain water might cause any problems, Seal the water leakage point tightly using a silicone adhesive or caulking compound.

10-4-2. Precautions about installation in Regions with Snowfall and Cold Temperatures

- Do not use the supplied drain nipple for draining water. Drain the water from all the drain holes directly.
- To protect the outdoor unit from snow accumulation, install a holding frame, and attach a snow protection hood and plate.
- * Do not use a double-stacked design.

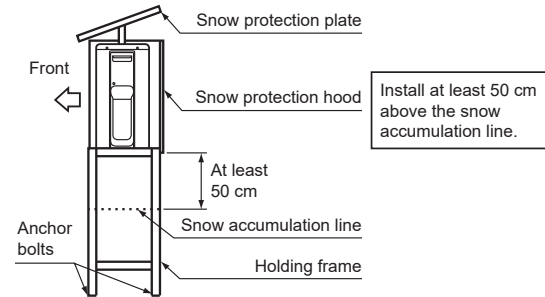

Fig. 10-4-1

CAUTION

1. Install the outdoor unit without anything blocking the air discharging.
2. When the outdoor unit is installed in a place exposed always exposed to strong wind like a coast or on a high storey of a building, secure the normal fan operation using a duct or a wind shield.
3. In particularly windy areas, install the unit such as to avoid admission of wind.
4. Installation in the following places may result in trouble.
Do not install the unit in such places.
 - A place full of machine oil.
 - A saline-place such as the coast.
 - A place full of sulfide gas.
 - A place where high-frequency waves are likely to be generated as from audio equipment, welders, and medical equipment.

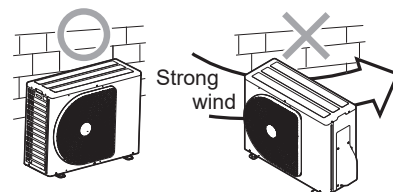
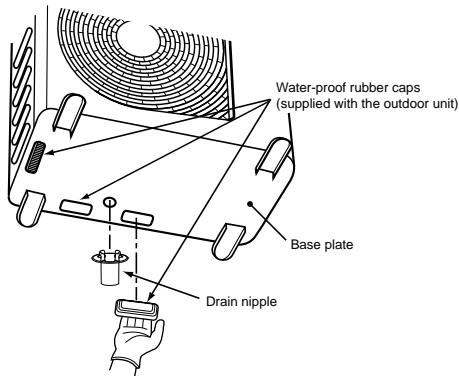

Fig. 10-4-2

Draining the Water

• Holes are provided on the base plate of the outdoor unit to ensure that the defrost water produced during heating operations is drained off efficiently. If a centralized drain is required when installing the unit on a balcony or wall, follow the steps below to drain off the water.

1. Proceed with water-proofing by installing the water-proof rubber caps in the 3 elongated holes on the base plate of the outdoor unit. [How to install the water-proof rubber caps]
 - 1) Place four fingers into each cap, and insert the caps into the water drain holes by pushing them into place from the underside of the base plate.
 - 2) Press down on the outer circumferences of the caps to ensure that they have been inserted tightly. (Water leaks may result if the caps have not been inserted properly, if their outer circumferences lift up or the caps catch on or wedge against something.)



2. Install the drain nipple and a commercially available drain hose (32 mm inside diameter), and drain off the water. (For the position where the drain nipple is installed, refer to the installation diagram of the indoor and outdoor units.)
 - Check that the outdoor unit is horizontal, and route the drain hose at a downward sloped angle while ensuring that it is connected tautly.

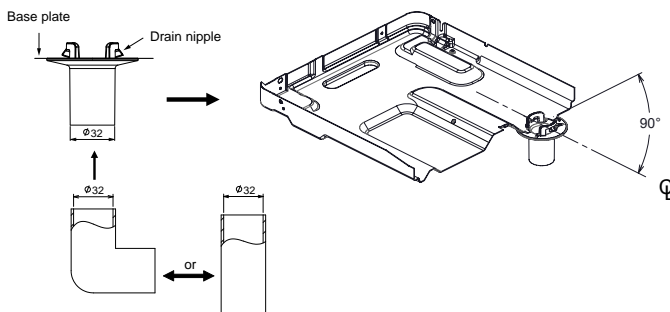

Commercially available drain hose

Do not use ordinary garden hose, but one can flatten and prevent water from draining.

10-4-3. Refrigerant piping connection

<Flaring>

1. Cut the pipe with a pipe cutter.

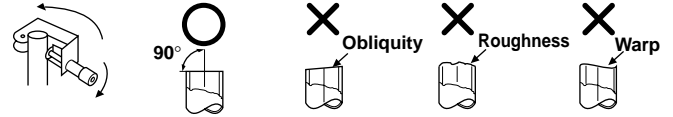

Fig. 10-4-3

2. Insert a flare nut into the pipe, and flare the pipe.
 - Projection margin in flaring : A (Unit : mm)

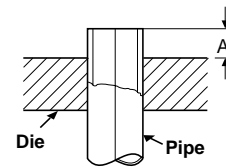

Fig. 10-4-4

RIDGID (clutch type)

| Outer dia. of copper pipe | Tool used | Conventional tool used |
|---------------------------|----------------|------------------------|
| Ø6.35 | 0 to 0.5 | 1.0 to 1.5 |
| Ø9.52 | 0 to 0.5 | 1.0 to 1.5 |
| Ø12.70 | 0 to 0.5 | 1.0 to 1.5 |
| Pipes thickness | 0.8 mm or more | |

IMPERIAL (wing nut type)

| Outer dia. of copper pipe | Tool used |
|---------------------------|----------------|
| Ø6.35 | 1.5 to 2.0 |
| Ø9.52 | 1.5 to 2.0 |
| Ø12.70 | 2.0 to 2.5 |
| Pipes thickness | 0.8 mm or more |

CAUTION

- Do not scratch the inner surface of the flared part when removing burrs.
- Flare processing under the condition of scratches on the inner surface of flare processing part will cause refrigerant gas leak.

<Tightening connection>

Align the centers of the connecting pipes and tighten the flare nut as far as possible with your fingers. Then tighten the nut with a spanner and torque wrench as shown in the figure.

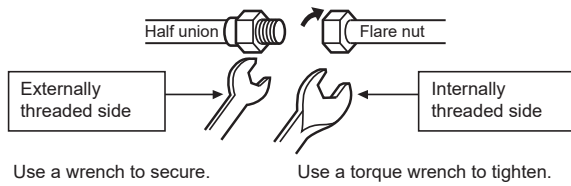

Fig. 10-4-5

CAUTION

Do not apply excess torque. Otherwise, the nut may crack depending on the conditions.

(Unit : N•m)

| Outer dia. of copper pipe | Tightening torque |
|---------------------------|-----------------------------|
| Ø6.35 mm | 16 to 18 (1.6 to 1.8 kgf•m) |
| Ø9.52 mm | 33 to 42 (3.3 to 4.2 kgf•m) |
| Ø12.70 mm | 50 to 62 (5.0 to 6.2 kgf•m) |

Tightening torque of flare pipe connections

The operating pressure of R32 is higher than that of R22 (approx. 1.6 times). It is therefore necessary to firmly tighten the flare pipe connecting sections (which connect the indoor and outdoor units) up to the specified tightening torque. Incorrect connections may cause not only a gas leakage, but also damage to the refrigeration cycle.

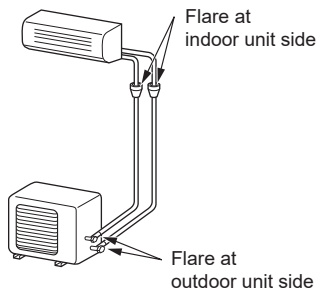

Fig. 10-4-6

Evacuating

After the piping has been connected to the indoor unit, you can perform the air purge together at once.

AIR PURGE

Evacuate the air in the connecting pipes and in the indoor unit using a vacuum pump. Do not use the refrigerant in the outdoor unit. For details, see the manual of the vacuum pump.

<Using a vacuum pump>

Be sure to use a vacuum pump with counter-flow prevention function so that inside oil of the pump does not flow backward into pipes of the air conditioner when the pump stops. (If oil inside of the vacuum pump enters into the air conditioner, which use R32, refrigeration cycle trouble may result.)

1. Connect the charge hose from the manifold valve to the service port of the packed valve at gas side.
2. Connect the charge hose to the port of the vacuum pump.
3. Open fully the low pressure side handle of the gauge manifold valve.
4. Operate the vacuum pump to start evacuating. Perform evacuating for about 15 minutes if the piping length is 20 meters. (15 minutes for 20 meters)(assuming a pump capacity of 27 liters per minute) Then confirm that the compound pressure gauge reading is -101 kPa (-76 cmHg).
5. Close the low pressure side valve handle of the gauge manifold valve.
6. Open fully the valve stem of the packed valves (both gas and liquid sides).
7. Remove the charging hose from the service port.
8. Securely tighten the caps on the packed valves.

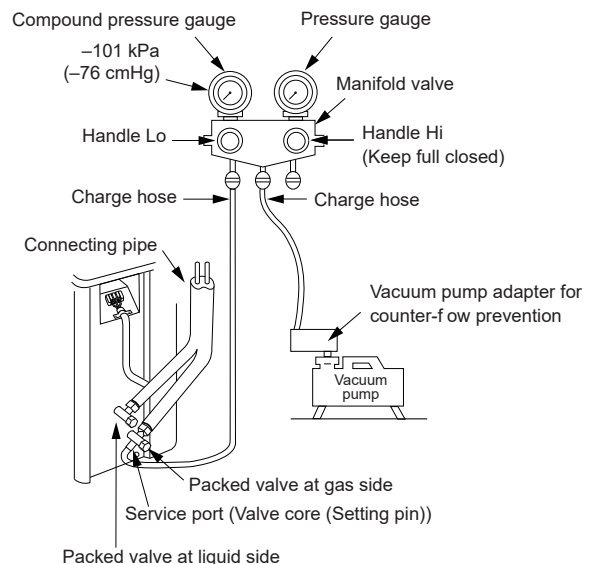

Fig. 10-4-7

CAUTION

• KEEP IMPORTANT 6 POINTS FOR PIPING WORK.

- (1) Take away dust and moisture (inside of the connecting pipes).
- (2) Tighten the connections (between pipes and unit).
- (3) Evacuate the air in the connecting pipes using a VACUUM PUMP.
- (4) Check gas leak (connected points).
- (5) Be sure to fully open the packed valves before operation.
- (6) Reusable mechanical connectors and flared joints are not allowed indoors. When mechanical connectors are reused indoors, sealing parts shall be renewed. When flared joints are reused indoors, the flare part shall be refabricated.

<Packed valve handling precautions>

- Open the valve stem all the way out, but do not try to open it beyond the stopper.

| Pipe size of Packed Valve | Size of Hexagon wrench |
|---------------------------|------------------------|
| 12.70 mm and smaller | A = 4 mm |
| 15.88 mm | A = 5 mm |

- Securely tighten the valve cap with torque in the following table

| Cap | Cap Size (H) | Torque |
|------------------|--------------|---------------------------------|
| Valve Rod Cap | H17 - H19 | 14~18 N.m (1.4 to 1.8 kgf·m) |
| | H22 - H30 | 33~42 N.m (3.3 to 4.2 kgf·m) |
| Service Port Cap | H14 | 8~12 N.m (0.8 to 1.2 kgf·m) |
| | H17 | 14~18 N.m (1.4 to 1.8 kgf·m) |

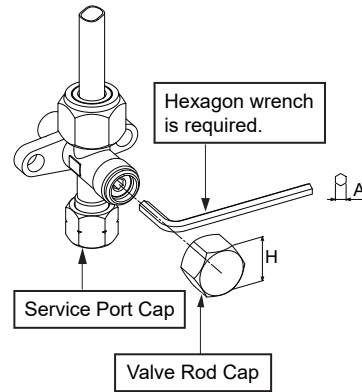

Fig. 10-4-8

10-5. Electrical works

The power supply can be selected to connect to indoor unit or outdoor unit. Choose proper way and connect the power supply and connecting cable by follow the instruction as following.

| Model | RAS-25N4KVPG-ND | RAS-35N4KVPG-ND |
|-------------------------|--|--|
| Power source | 50Hz, 220 - 240V Single phase | |
| Maximum running current | 12.00A | 12.50A |
| Circuit breaker rating | 20A | 20A |
| Power supply cable | H07RN-F or 60245 IEC66 (2.0 mm ² or more) | H07RN-F or 60245 IEC66 (2.0 mm ² or more) |
| Connecting cable | | |

10-5-1. Wiring Connection

Indoor unit

Wiring of the cable can be carried out without removing the main panel.

1. Remove the front panel.
Pull and lift up front panel until it stops, move arms on left and right side to outward direction then pull toward you to remove front panel.
* Beware front panel fall down that may cause of injure or part damage.

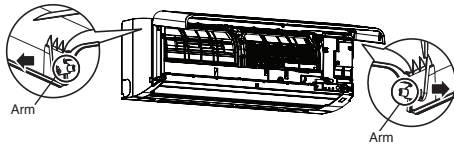

Fig. 10-5-1

2. Remove the terminal cover and cord clamp.
3. Insert the cable (according to the local cords) into the pipe hole on the wall.
4. Take out the cable protrudes about 20 cm from the front.
5. Insert the cable fully into the terminal block and secure it tightly with screws.
6. Tightening torque : 1.2 N·m (0.12 kgf·m)
7. Secure the cable with the cord clamp.
8. Fix the terminal cover and attach front panel to the indoor unit.

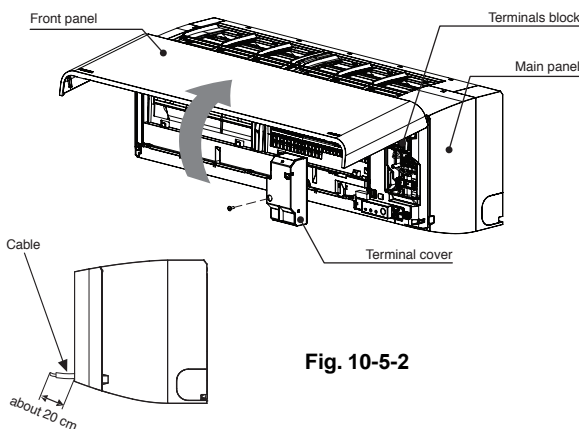

Fig. 10-5-2

How to attach the front panel

Carry out attaching in the reverse order to removal.
Keep front panel horizontally and put both arms into guides. Make sure both arms are inserted completely. If the gap between main panel and front panel isn't even, remove and attach again.

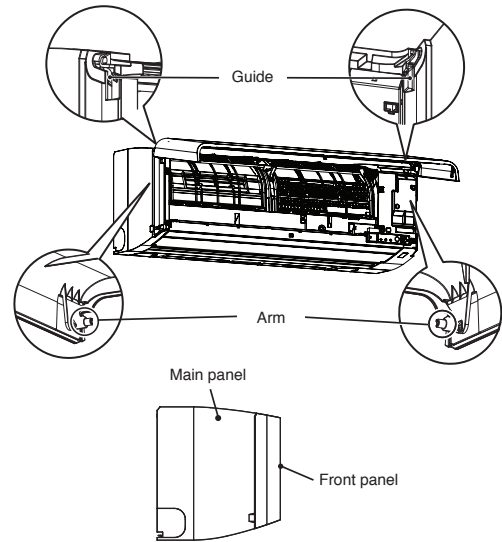

Fig. 10-5-3

CAUTION

- Be sure to refer to the wiring system diagram labeled inside the main panel.
- Check local electrical cords and also any specific wiring instructions or limitations.

Outdoor unit

1. Remove the valve cover from the outdoor unit.
2. Connect the cable to the terminals as identified with their respective matched numbers on the terminal block of indoor and outdoor unit.
3. When connecting the cable to the outdoor unit terminals, make a loop as shown in the installation diagram of indoor and outdoor unit to prevent water coming in the outdoor unit.
4. Insulate the unused cords (conductors) from any water coming in the outdoor unit. Proceed them so that they do not touch any electrical or metal parts.

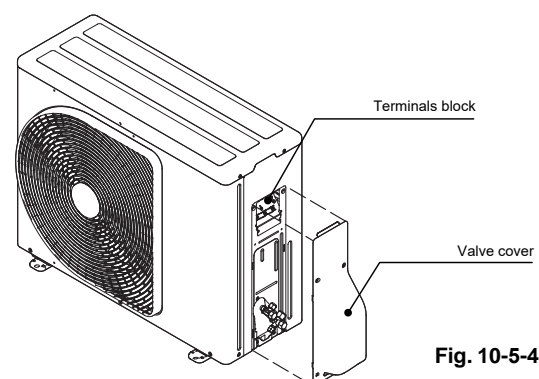
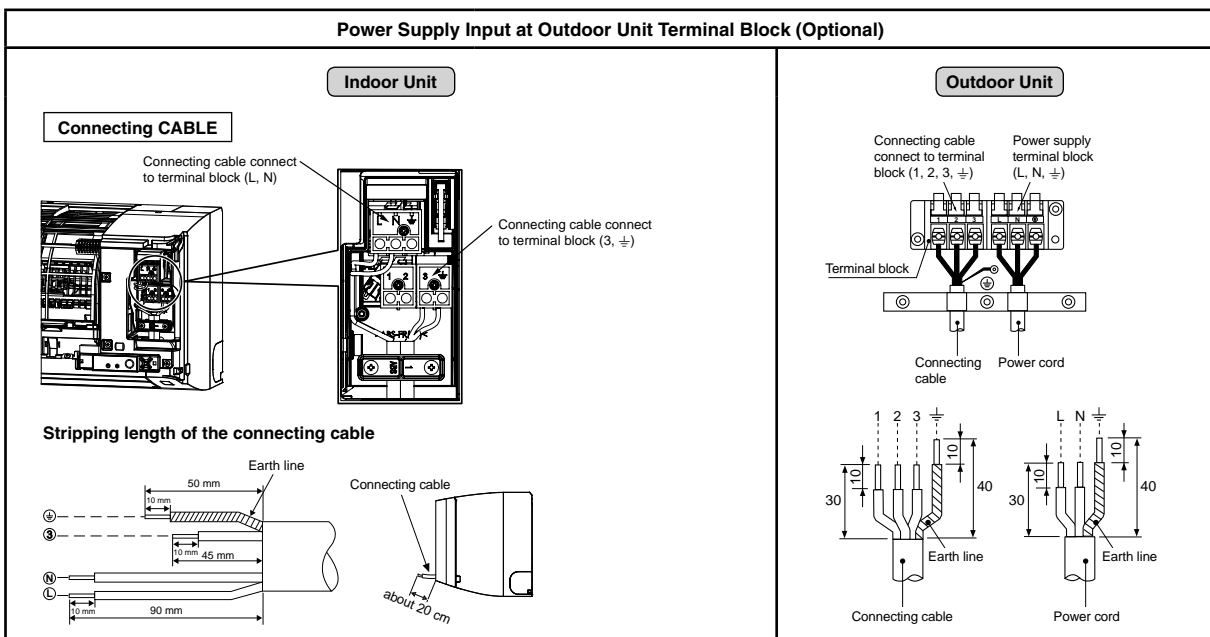
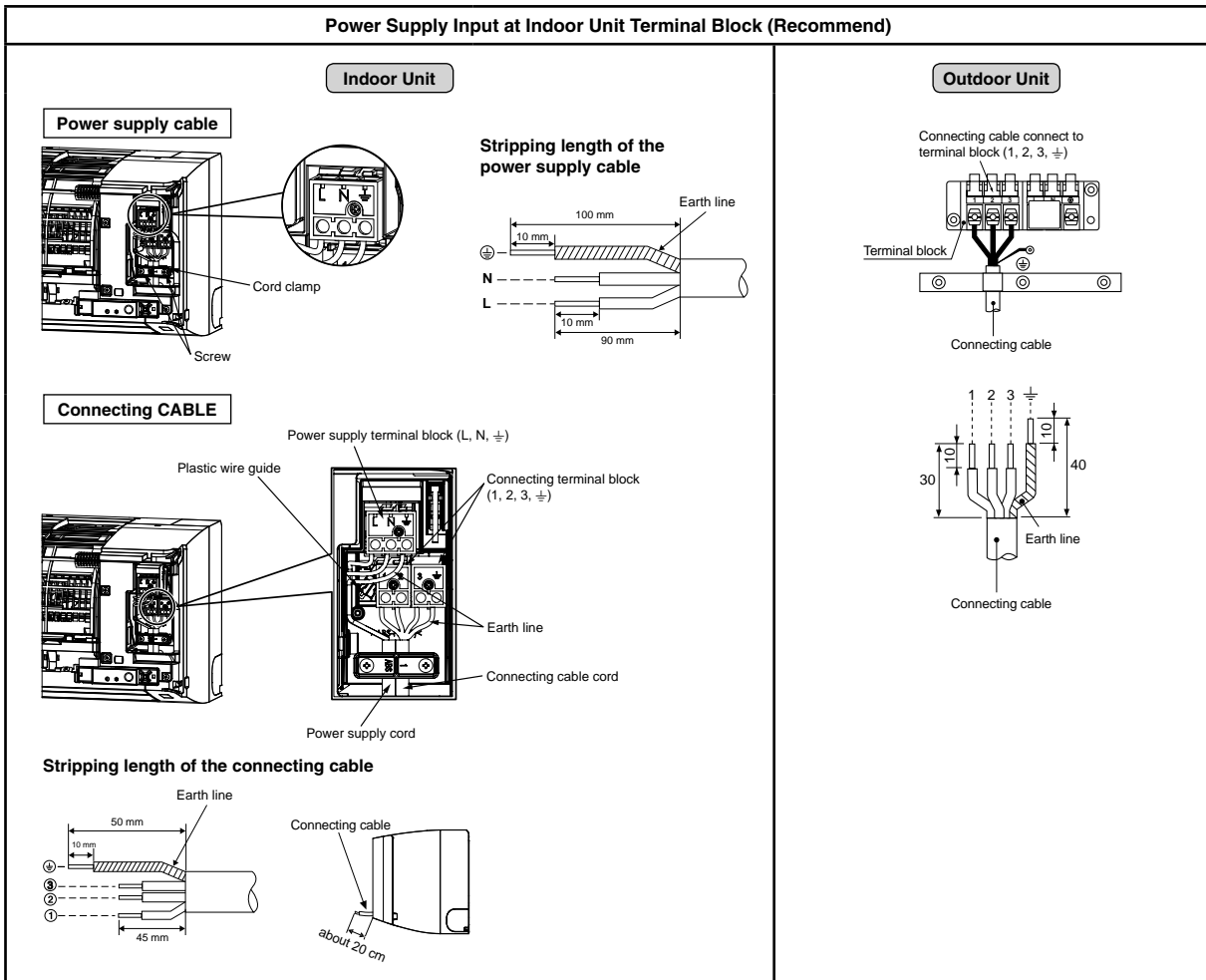

Fig. 10-5-4

10-5-2. Power Supply and Connecting Cable Connection



10-5-3. Power Supply input Wiring Diagram

Power supply input at Indoor unit Terminal Block (Recommend)

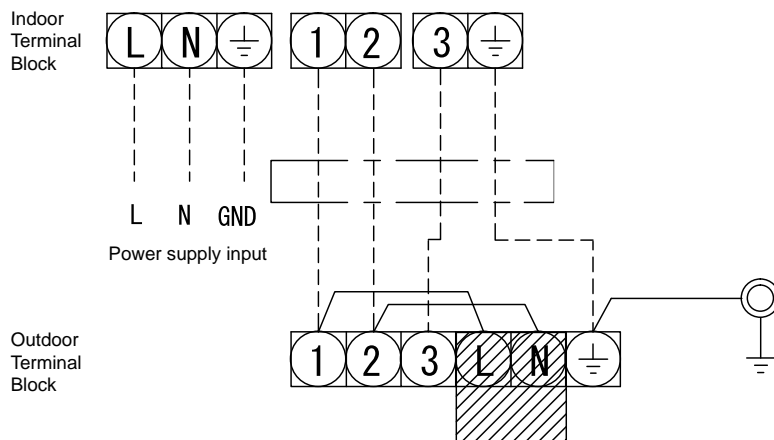

Power supply input at Outdoor unit Terminal Block (Optional)

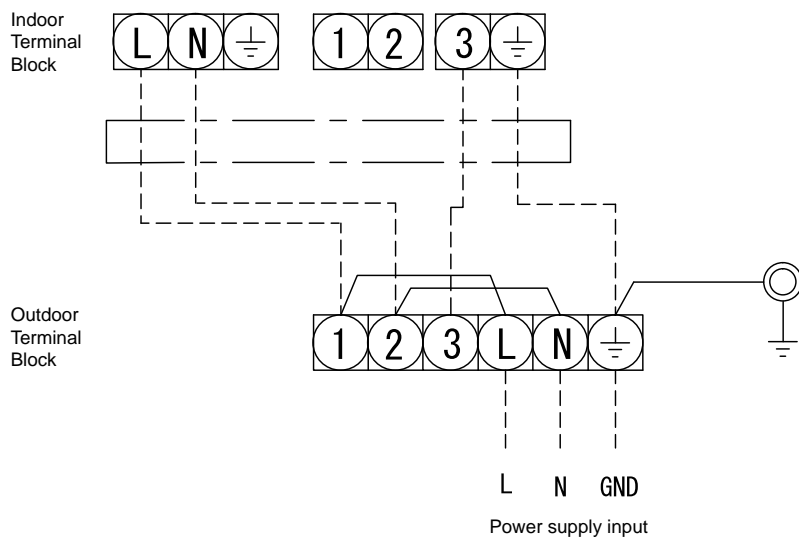

CAUTION

1. The power supply must be same as the rated of air conditioner.
2. Prepare the power source for exclusive use with air conditioner.
3. Circuit breaker must be used for the power supply line of this air conditioner.
4. Be sure to comply power supply and connecting cable for size and wiring method.
5. Every wire must be connected firmly.
6. Perform wiring works so as to allow a general wiring capacity.
7. Wrong wiring connection may cause some electrical part burn out.
8. Incorrect or incomplete wiring is carried out, it will cause an ignition or smoke.
9. This product can be connected to main power supply.
Connection to fixed wiring : A switch which disconnects all poles and has a contact separation at least 3mm must be incorporated in the fixed wiring.

10-5-4. Fuse Specification and Local Heating Cable Connection

Fuse Specification and Local Heating Cable Connection Recommend

Outdoor nit

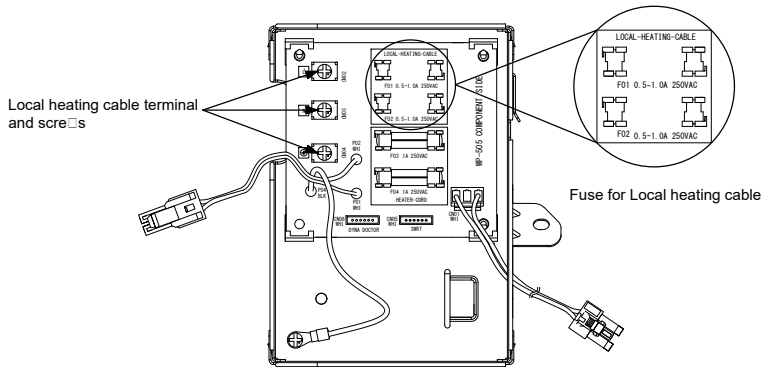

Fuse Spec.

Maximum Local heating cable is 90W

| Local heating cable spec. | Fuse specification |
|---------------------------|--------------------|
| 15 ~ 75 W | 0.5 A |
| 76 ~ 90 W | 1.0 A |

How to open fuse box?

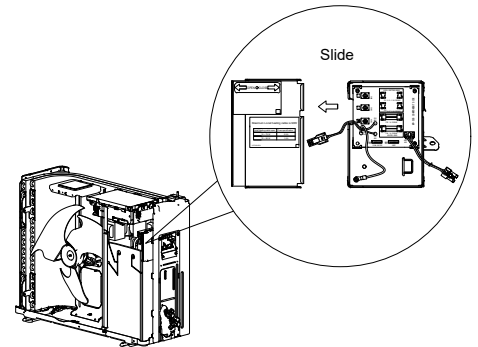

Local heating cable

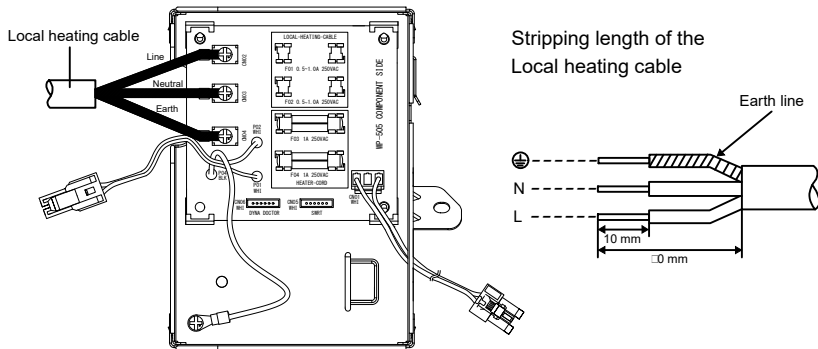

10-6. Others

10-6-1. Gas leak test

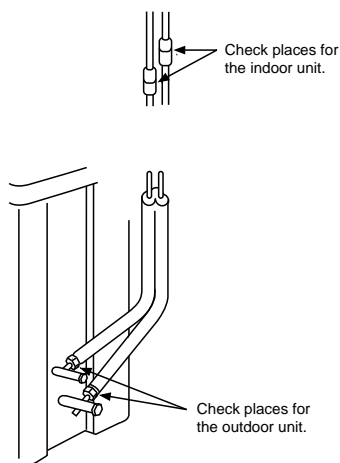

Fig. 10-6-1

- Check the flare nut connections for the gas leak with a gas leak detector or soap water.

10-6-2. Remote Control A-B Selection

- When two indoor units are installed in the same room or adjacent two rooms, if operating a unit, two units may receive the remote control signal simultaneously and operate. In this case, the operation can be preserved by setting either one remote control to B setting. (Both are set to A setting in factory shipment.)
- The remote control signal is not received when the settings of indoor unit and remote control are different.
- There is no relation between A setting/B setting and A room/B room when connecting the piping and cables.

To separate using of remote control for each indoor unit in case of 2 air conditioner are installed near.

Remote Control B Setup.

1. Press RESET button on the indoor unit to turn the air conditioner ON.
2. Point the remote control at the indoor unit.
3. Push and hold CHECK button on the Remote Control by the tip of the pencil. "00" will be shown on the display.
4. Press MODE during pushing CHECK "B" will show on the display and "00" will disappear and the air conditioner will turn OFF. The Remote Control B is memorized.

- Note :
1. Repeat previous step to reset Remote Control to be A.
 2. Remote Control A has not "A" display.
 3. Default setting of Remote Control from factory is A.

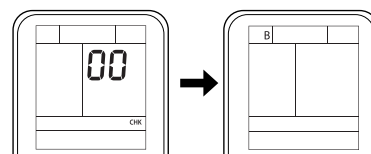

Fig. 10-6-2

10-6-3. Test operation

To switch the TEST RUN (COOL) mode, press Temporary switch for 10 sec.
(The unit will make a short Pi sound.)

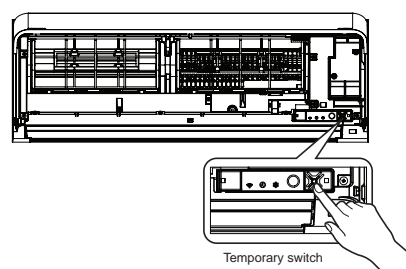

Fig. 10-6-3

10-6-4. Auto restart

This product is designed so that, after a power failure, it can restart automatically in the same operating mode as before the power failure.

Information

The product is shipped with Auto Restart function in the ON position. Turn it OFF if this function is not required.

How to turn OFF the Auto Restart Function

- Press and hold the [OPERATION] button on the indoor unit for 3 seconds (3 beep sounds but OPERATION lamp does not blink).

How to turn ON the Auto Restart Function

- Press and hold the [OPERATION] button on the indoor unit for 3 seconds (3 beep sounds and OPERATION lamp 5 time/sec for 5 seconds).

NOTE

- In case of ON timer or OFF timer are set, AUTO RESTART OPERATION does not activate.
- Default setting of AUTO RESTART OPERATION is ON.

11. HOW TO DIAGNOSE THE TROUBLE

The pulse motor circuits are mounted to both indoor and outdoor units.

Therefore, diagnose troubles according to the trouble diagnosis procedure as described below.

(Refer to the check points in servicing written on the wiring diagrams attached to the indoor/outdoor units.)

Table 11-1

| No. | Troubleshooting Procedure |
|-----|--|
| 1 | First Confirmation |
| 2 | Primary Judgment |
| 3 | Judgment by Flashing LED of Indoor Unit |
| 4 | Self-Diagnosis by Remote Controller (Check Code) |
| 5 | Judgment of Trouble by Every Symptom |
| 6 | Check Code 18 and 1E |
| 7 | Troubleshooting |
| 8 | How to Diagnose Trouble in Outdoor Unit |
| 9 | How to Check Simply the Main Parts |
| 10 | How to Simply Judge Whether Outdoor Fan Motor is Good or Bad |

◆ Precautions when handling the new inverter

⚠ CAUTION: HIGH VOLTAGE

The high voltage circuit is incorporated.

Be careful to do the check service, as the electric shock may be caused in case of touching parts on the P.C. board by hand.

The new inverter will be incorporated starting with this unit.

◆ The control circuitry has an uninsulated construction.

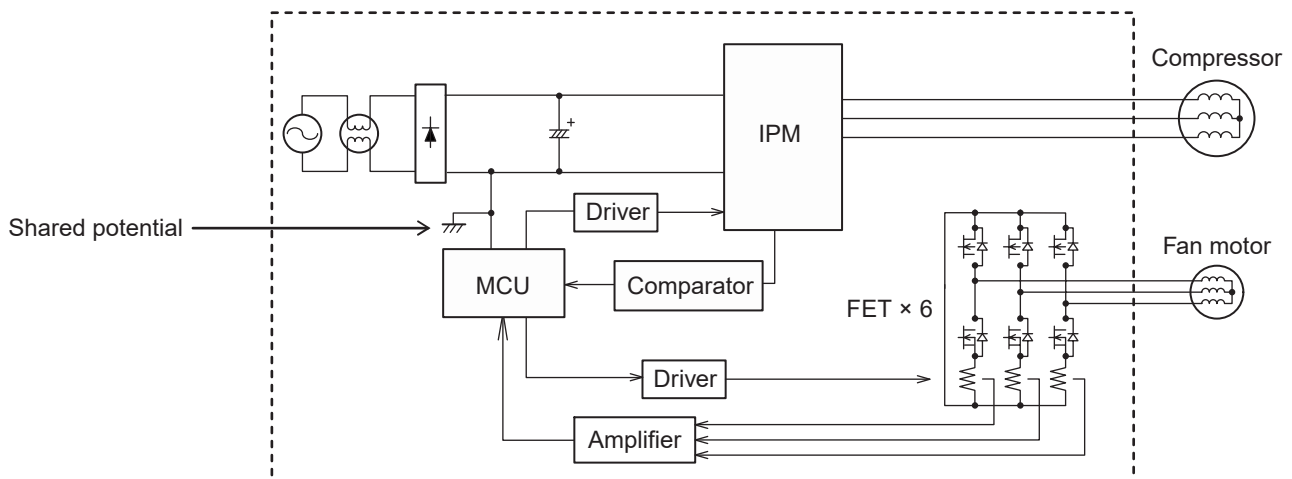

Fig. 11-1

⚠ CAUTION

A high voltage (equivalent to the supply voltage) is also energized to ground through the sensors, PMV and other low-voltage circuits. The sensor leads and other wires are covered with insulated tubes for protection. Nevertheless, care must be taken to ensure that these wires are not pinched.

Take sufficient care to avoid directly touching any of the circuit parts without first turning off the power.

At times such as when the circuit board is to be replaced, place the circuit board assembly in a vertical position.

Laying the board flat on an electrically conductive object (such as the top panel of the air conditioner's outdoor unit) while a charge is still retained by the electrolytic capacitors of the inverter's main circuit may cause short-circuiting between the electrolytic capacitors and secondary circuit components and result in damage to the components.

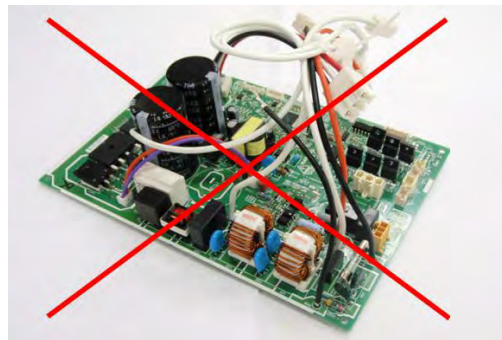

Fig. 11-2

Do NOT lay the circuit board assembly flat.

◆ Precautions when inspecting the control section of the outdoor unit

NOTE :

A large-capacity electrolytic capacitor is used in the outdoor unit controller (inverter). Therefore, if the power supply is turned off, charge (charging voltage DC280 to 380V) remains and discharging takes a lot of time. After turning off the power source, if touching the charging section before discharging, an electrical shock may be caused. Discharge the electrolytic capacitor completely by using soldering iron, etc.

< Discharging method >

1. Remove the inverter cover (plating) by opening four mounting claws.
2. As shown below, connect the discharge resistance (approx. 100Ω40W) or plug of the soldering iron to voltage between + – terminals of the C10 ("CAUTION HIGH VOLTAGE" is indicated.) electrolytic capacitor (760μF/400V) on P.C. board, and then perform discharging.

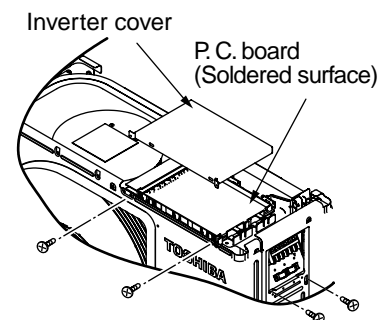
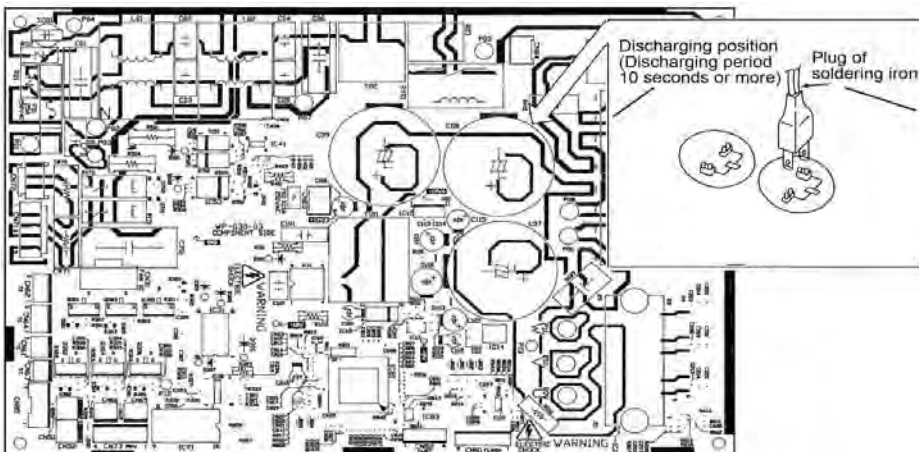

Fig. 11-3

11-1. First Confirmation

11-1-1. Confirmation of Power Supply

Confirm that the power breaker operates (ON) normally.

11-1-2. Confirmation of Power Voltage

Confirm that power voltage is AC 220–230–240 ± 10%.

If power voltage is not in this range, the unit may not operate normally.

11-1-3. Operation Which is not a Trouble (Program Operation)

For controlling the air conditioner, the program operations are built in the microcomputer as described in the following table.

If a claim is made for running operation, check whether or not it meets to the contents in the following table.

When it does, we inform you that it is not trouble of equipment, but it is indispensable for controlling and maintaining of air conditioner.

Table 11-1-1

| No. | Operation of air conditioner | Description |
|-----|--|--|
| 1 | When power breaker is turned "ON", the operation indicator (white) of the indoor unit flashes. | The OPERATION lamp of the indoor unit flashes when power source is turned on. If [⏻] button is operated once, flashing stops. (Flashes also in power failure) |
| 2 | Compressor may not operate even if the room temperature is within range of compressor-ON. | The compressor does not operate while compressor restart delay timer (3-minutes timer) operates. The same phenomenon is found after power source has been turned on because 3-minutes timer operates. |
| 3 | In Dry and ECO mode, FAN (air flow) display does not change even though FAN (air flow select) button is operated. | The air flow indication is fixed to [AUTO]. |
| 4 | In AUTO mode, the operation mode is changed. | After selecting Cool or Heat mode, select an operation mode again if the compressor keeps stop status for 15 minutes. |
| 5 | In HEAT mode, the compressor motor speed does not increase up to the maximum speed or decreases before the temperature arrives at the set temperature. | The compressor motor speed may decrease by high-temp. release control (Release protective operation by temp.-up of the indoor heat exchanger) or current release control. |

11-2. Primary Judgment

To diagnose the troubles, use the following methods.

- 1) Judgment by flashing LED of indoor unit
- 2) Self-diagnosis by service check remote controller
- 3) Judgment of trouble by every symptom

Firstly use the method 1) for diagnosis. Then, use the method 2) or 3) to diagnose the details of troubles.

11-3. Judgment by Flashing LED of Indoor Unit

While the indoor unit monitors the operation status of the air conditioner, if the protective circuit operates, the contents of self-diagnosis are displayed with block on the indoor unit indication section.

Table 11-3-1

| | Item | Check code | Block display | Description for self-diagnosis | | | | | | | | | | | | | | |
|--|------------|-----------------|--|--|-------|--|--------|--------|---------|------------|------|-----------------|--------------------------------------|------|------------|------|------------|------------|
| <div style="border: 1px solid black; padding: 5px; width: fit-content;">Indoor indication lamp flashes.</div> <div style="margin-left: 20px;">↓</div> <div style="border: 1px solid black; padding: 5px; width: fit-content;">Which lamp does flash?</div> <div style="margin-left: 20px;">↓</div> <div style="margin-left: 20px;">→</div> | A | — | OPERATION Flashing display (1 Hz) | Power failure (when power is ON) | | | | | | | | | | | | | | |
| | B | 00 | OPERATION Flashing display (5 Hz) | Protective circuit operation for indoor P.C. board | | | | | | | | | | | | | | |
| | C | 01 | OPERATION TIMER (White) Flashing display (5 Hz) | Protective circuit operation for connecting cable and serial signal system | | | | | | | | | | | | | | |
| | D | 02 | OPERATION Flashing display (5 Hz) | Protective circuit operation for outdoor P.C. board | | | | | | | | | | | | | | |
| | E | 03 | OPERATION TIMER Flashing display (5 Hz) | Protective circuit operation for others (including compressor) | | | | | | | | | | | | | | |
| | F | 33 | <table border="1" style="border-collapse: collapse; width: 100%;"> <tr> <td style="width: 50%;">OPERATION</td> <td style="width: 50%;">TIMER</td> <td></td> </tr> <tr> <td>Normal</td> <td>Normal</td> <td>Nothing</td> </tr> <tr> <td>Flash 1 Hz</td> <td>None</td> <td>Current release</td> </tr> <tr> <td>Flash 2 Hz 2 times every 1 sec</td> <td>None</td> <td>TD release</td> </tr> <tr> <td>None</td> <td>Flash 1 Hz</td> <td>TC release</td> </tr> </table> | OPERATION | TIMER | | Normal | Normal | Nothing | Flash 1 Hz | None | Current release | Flash 2 Hz 2 times every 1 sec | None | TD release | None | Flash 1 Hz | TC release |
| OPERATION | TIMER | | | | | | | | | | | | | | | | | |
| Normal | Normal | Nothing | | | | | | | | | | | | | | | | |
| Flash 1 Hz | None | Current release | | | | | | | | | | | | | | | | |
| Flash 2 Hz 2 times every 1 sec | None | TD release | | | | | | | | | | | | | | | | |
| None | Flash 1 Hz | TC release | | | | | | | | | | | | | | | | |

NOTES :

1. The contents of items B and C and a part of item E are displayed when air conditioner operates.
2. When item B and C, and item B and a part of item E occur concurrently, priority is given to the block of item B.
3. The check codes can be confirmed on the remote controller for servicing.

11-4. Self-Diagnosis by Remote Controller (Check Code)

1. If the lamps are indicated as shown B to E in Table 11-4-1, execute the self-diagnosis by the remote controller.
2. When the remote controller is set to the service mode, the indoor controller diagnoses the operation condition and indicates the information of the self-diagnosis on the display of the remote controller with the check codes. If a fault is detected, all lamps on the indoor unit will flash at 5Hz and it will beep for 10 seconds (Beep, Beep, Beep...). The timer lamp usually flashes (5Hz) during self-diagnosis.

11-4-1. How to Use Remote Controller in Service Mode

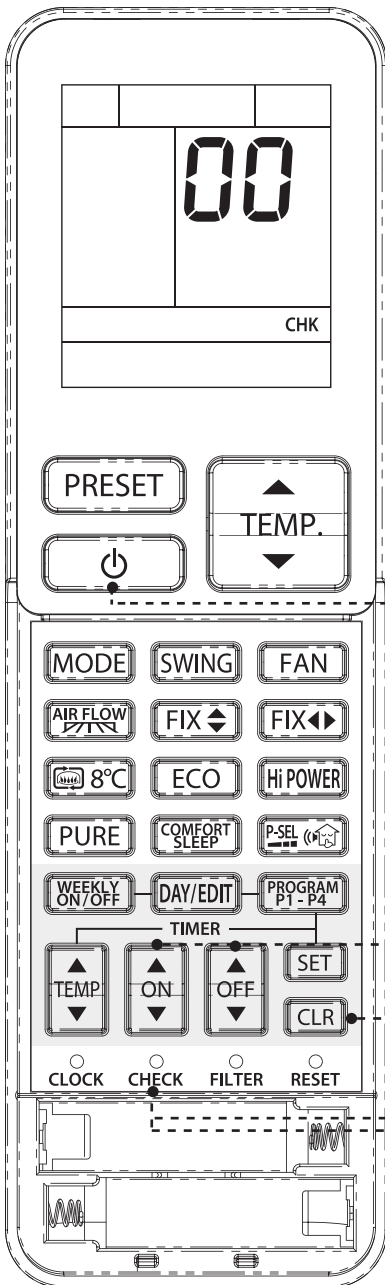

1 Press [CHECK] button with a tip of pencil to set the remote controller to the service mode.

- "00" is indicated on the display of the remote controller.

2 Press [ON / OFF ▲] button

If there is no fault with a code, the indoor unit will beep once (Beep) and the display of the remote controller will change as follows :

00 → 01 → 02 ... 1d → 1E → 33

- The TIMER indicator of the indoor unit flashes continuously. (5 times per 1 sec.)
- Check the unit with all 52 check codes (00 to 33) as shown in Table-11-4-1.
- Press [ON / OFF ▼] button to change the check code backward.

If there is a fault, the indoor unit will beep for 10 seconds (Beep, Beep, Beep...).

Note the check code on the display of the remote controller.

- 2-digits alphanumeric will be indicated on the display.
- All indicators on the indoor unit will flash. (5 times per 1 sec.)

3 Press [CHECK] then [CLR] button. After service finish for clear service code in memory.

- "7F" is indicated on the display of the remote control.

4 Press [⏻] button to release the service mode.

- The display of the remote controller returns to as it was before service mode was engaged.

Alphanumeric characters are used for the check codes.

| | |
|---------|---------|
| 5 is 5. | 6 is 6. |
| A is A. | B is B. |
| C is C. | D is D. |

Fig. 11-4-1

11-4-2. Caution at Servicing

1. After using the service mode of remote controller finished, press the [⏻] button to reset the remote controller to normal function.
2. After finished the diagnosis by the remote controller, turn OFF power supply and turn its ON again to reset the air conditioner to normal operation. However, the check codes are not deleted from memory of the microcomputer.
3. After servicing finished, press [CLR] button of remote controller under service mode status to send code "7F" to the indoor unit. The check code stored in memory is cleared.

Table 11-4-1

| Block distinction | | Operation of diagnosis function | | | | Action and Judgment |
|-------------------|--------------------|---------------------------------|--|--|---------------------------------|--|
| Check code | Block | Check code | Cause of operation | Air conditioner status | Display flashing error | |
| 00 | Indoor P.C. board. | 01 | TA sensor ; The room temperature sensor is short-Circuit or disconnection. | Operation continues. | Flashes when error is detected. | 1. Check the sensor TA and connection. 2. In case of the sensor and its connection is normal, check the P.C. board. |
| | | 02 | TC sensor ; The heat exchanger temperature sensor of the indoor unit is out of place, disconnection, short-circuit or migration. | Operation continues. | Flashes when error is detected. | 1. Check the sensor TC and connection. 2. In case of the sensor and its connection is normal, check the P.C. board. |
| | | 0E | Gas detector sensor failure | Outdoor Unit "OFF" Indoor Unit continue fan only operation for 250 minute or "OFF". | Flashes when error is detected. | 1. Check Gas sensor shortage / open. 2. Check Gas sensor disconnect. |
| | | 11 | Fan motor of the indoor unit is failure, lock-rotor, short-circuit, disconnection, etc. Or its circuit on P.C. board has problem. | All OFF | Flashes when error is detected. | 1. Check the fan motor and connection. 2. In case of the motor and its connection is normal, check the P.C. board. |
| | | 12 | Other trouble on the indoor P.C. board. | Depend on cause of failure. | Depend on cause of failure. | 1. Reset power supply. 2. Replace P.C. board. |
| | | 25 | Gas detector sensor life time | Operation continues. | Flashes when error is detected. | Replace new sensor. |

| Block distinction | | Operation of diagnosis function | | | | Action and Judgment |
|-------------------|-------------------------------------|---------------------------------|---|--|--|--|
| Check code | Block | Check code | Cause of operation | Air conditioner status | Display flashing error | |
| 01 | Serial signal and connecting cable. | 04 | 1) Defective wiring of the connecting cable or miss-wiring. 2) Operation signal has not send from the indoor unit when operation start. 3) Outdoor unit has not send return signal to the indoor unit when operation started. 4) Return signal from the outdoor unit is stop during operation. <ul style="list-style-type: none"> • Some protector (hardware, if exist) of the outdoor unit open circuit of signal. • Signal circuit of indoor P.C. board or outdoor P.C. board is failure in some period. | Indoor unit operates continue. Outdoor unit stop. | Flashes when error is detected. Flashing stop and outdoor unit start to operate when the return signal from the outdoor unit is normal. | 1) to 3) The outdoor unit never operate. <ul style="list-style-type: none"> • Check connecting cable and correct if defective wiring. • Check 25A fuse of inverter P.C. board. • Check 3.15A fuse of inverter P.C. board. • Check operation signal of the indoor unit by using diode. Measure voltage at terminal block of the indoor unit between No.2 and No.3 (or L2 and S) If signal is varied 15-60V continuously, replace inverter P.C. board. If signal is not varied, replace indoor P.C. board. 4) The outdoor unit abnormal stop at some time. <ul style="list-style-type: none"> • If the other check codes are found concurrently, check them together. • Check protector (hardware) such as Hi-Pressure switch, Thermal-Relay, etc. • Check refrigerant amount or any possibility case which may caused high temperature or high pressure. • Check operation signal of the indoor unit by using diode. Measure voltage at terminal block of the indoor unit between No.2 and No.3 (or L2 and S) If signal is varied 15-60V continuously, replace inverter P.C. board. If signal is not varied, replace indoor P.C. board. |

Note : Operation signal of the indoor unit shall be measured in the sending period as picture below.

Sending signal of the indoor unit when have not return signal from the outdoor unit.

* Signal send only 1 minute and stop. Because of return signal from outdoor unit has not received.
 ** Signal resend again after 3 minutes stop. And the signal will send continuously.
 *** 1 minute after resending, the indoor unit display flashes error.

| Block distinction | | Operation of diagnosis function | | | | Action and Judgment |
|-------------------|--------------------|---------------------------------|--|------------------------|---|--|
| Check code | Block | Check code | Cause of operation | Air conditioner status | Display flashing error | |
| 02 | Outdoor P.C. board | 14 | Current on inverter circuit is over limit in short time. <ul style="list-style-type: none"> Inverter P.C. board is failure, IGBT shortage, etc. Compressor current is higher than limitation, lock rotor, etc. | All OFF | Flashes after error is detected 8 times*. | <ol style="list-style-type: none"> Remove connecting lead wire of the compressor, and operate again. If outdoor fan does not operate or operate but stop after some period, replace the inverter P.C. board. If outdoor fan operates normally, measure 3-Phase output of inverter P.C. board (150-270VAC) at the connecting lead wire of compressor. If 3-Phase output is abnormal, replace inverter P.C.Board. If 3-Phase output is normal, replace compressor. (lock rotor, etc.) |
| | | 15 | Compressor position-detect circuit error or short-circuit between winding of compressor. | All OFF | Flashes after error is detected 8 times*. | <ol style="list-style-type: none"> Remove connecting lead wire of the compressor, and operate again. If outdoor fan does not operate or operation but stop after some period, replace the inverter P.C. board. If outdoor fan operates normally, measure resistance of compressor winding. If circuit is shortage, replace the compressor. |
| | | 17 | Current-detect circuit of inverter P.C. board error. | All OFF | Flashes after error is detected 4 times*. | Even if trying to operate again, all operations stop, replace inverter P.C. board. |
| | | 18 | TE or TS sensor; abnormal. Out of place, disconnection, shortage, or misconnection (TE sensor is connected to TS connector, TS sensor is connected to TE sensor connector) TE sensor; Outdoor heat exchanger temperature sensor TS sensor; Suction pipe temperature sensor | All OFF | Flashes after error is detected 4 times*. | <ol style="list-style-type: none"> Check sensors, TE, TS connection. In case of sensors and it's connection is normal, check the inverter P.C. board Check 4way valve operation/position. In case TE, TS detected temperature relationship are different from normal operation, "18" might be detected. |
| | | 19 | TD sensor ; Discharge pipe temperature sensor is disconnection or shortage. | All OFF | Flashes after error is detected 4 times*. | <ol style="list-style-type: none"> Check sensors TD and connection. In case of the sensor and its connection is normal, check the inverter P.C. board. |
| | | 1A | Outdoor fan failure or its drive-circuit on the inverter P.C. board failure. | All OFF | Flashes after error is detected 8 times*. | <ol style="list-style-type: none"> Check the motor, measure winding resistance, shortage or lock rotor. Check the inverter P.C. board. |
| | | 1b | TO sensor ; The outdoor temperature sensor is disconnection or shortage. | Operation continues. | Record error after detected 4 times*. But does not flash display. | <ol style="list-style-type: none"> Check sensors TO and connection. In case of the sensor and its connection is normal, check the inverter P.C. board. |

| Block distinction | | Operation of diagnosis function | | | | Action and Judgment |
|---|-----------------------------------|---------------------------------|---|--|--|--|
| Check code | Block | Check code | Cause of operation | Air conditioner status | Display flashing error | |
| 02 | Outdoor P.C. board | 11 | Compressor drive output error. (Relation of voltage, current and frequency is abnormal) <ul style="list-style-type: none"> • Overloading operation of compressor caused by over-charge refrigerant, P.M.V. failure, etc. • Compressor failure (High current). | All OFF | Flashes after error is detected 8 times*. | <ol style="list-style-type: none"> 1. Check installation conditions such as packed valve opening, refrigerant amount and power supply (rate $\pm 10\%$, both of operation and non operation condition). 2. Check P.M.V. by measure the resistance of the coil and confirm its operation (sound of initial operation, etc.) 3. Observe any possibility cause which may affect operation load of compressor. 4. Operate again. If compressor operation is failure when 20 seconds passed (count time from operation starting of compressor), replace compressor. |
| <p>* 4, 8 or 18 times ; When first error is detected, error is count as 1 time, then once operation is stop and re-started. After re-starting operation within 6 minutes, if same error is detected, error count is add (count become 2 times) When error count comes 4, 8 or 18 times, record error to check code. But after re-starting operation, if no error is detected and air conditioner can operate more than 6 minutes, error count is cleared.</p> | | | | | | |
| 03 | The others (including compressor) | 07 | Return signal of the outdoor unit has been sent when operation start. But after that, signal is stop some time. <ul style="list-style-type: none"> • Instantaneous power failure. • Some protector (hardware) of the outdoor unit open circuit of signal. • Signal circuit of indoor P.C. board or outdoor P.C. board is failure in some period. | Indoor unit operates continue. Outdoor unit stop. | Flashes when error is detected. Flashing stop and outdoor unit start to operate when the return signal from the outdoor unit is normal. | <ol style="list-style-type: none"> 1. Check power supply (Rate $\pm 10\%$) 2. If the air conditioner repeat operates and stop with interval of approx. 10 to 40 minutes. <ul style="list-style-type: none"> • Check protector (hardware) such as Hi-Pressure switch, Thermal-Relay, etc. • Check refrigerant amount, packed valve opening and any possibility cause which may affect high temperature or high pressure. 3. Check operation signal of the indoor unit by using diode. Measure voltage at terminal block of the indoor unit between No.2 and No.3 (or L2 and S) If signal is varied 15-60V continuously, replace inverter P.C. board. If signal is not varied, replace indoor P.C. board. |

| Block distinction | | Operation of diagnosis function | | | | Action and Judgment |
|---|--------------------------------------|---------------------------------|---|------------------------|---|--|
| Check code | Block | Check code | Cause of operation | Air conditioner status | Display flashing error | |
| 03 | The others (including compressor) | 1D | Compressor does not rotate. Because of missed wiring, missed phase or shortage. | All OFF | Flashes after error is detected 8 times*. | <ol style="list-style-type: none"> 1. Remove connecting lead wire of the compressor, and operate again. 2. If outdoor fan does not operate or operation but stop after some period, replace the inverter P.C. board. 3. If outdoor fan operates normally, measure 3-Phase output of inverter P.C. board (150-270VAC) at the connecting lead wire of compressor. 4. If 3-Phase output is abnormal, replace inverter P.C.Board. 5. If 3-Phase output is normal, measure resistance of compressor winding. 6. If winding is shortage, replace the compressor. |
| | | 1E | Discharge temperature exceeded 117°C. | All OFF | Flashes after error is detected 4 times*. | <ol style="list-style-type: none"> 1. Check sensors TD. 2. Check refrigerant amount. 3. Check P.M.V. by measure the resistance of the coil and confirm its operation (sound of initial operation, etc.) 4. Observe any possibility cause which may affect high temperature of compressor. |
| | | 1F | Compressor is high current though operation Hz is decreased to minimum limit. <ul style="list-style-type: none"> • Installation problem. • Instantaneous power failure. • Refrigeration cycle problem. • Compressor break down. • Compressor failure (High current).operation, etc.) | All OFF | Flashes after error is detected 8 times*. | <ol style="list-style-type: none"> 1. Check installation conditions such as packed valve opening, refrigerant amount and power supply (rate $\pm 10\%$, both of operation and non operation condition). 2. Check P.M.V. by measure the resistance of the coil and confirm its operation (sound of initial operation, etc.) 3. Observe any possibility cause which may affect high current of compressor. 4. If 1, 2 and 3 are normal, replace compressor. |
| <p>* 4, 8 or 18 times ; When first error is detected, error is count as 1 time, then once operation is stop and re-started. After re-starting operation within 6 minutes, if same error is detected, error count is add (count become 2 times) When error count comes 4, 8 or 18 times, record error to check code. But after re-starting operation, if no error is detected and air conditioner can operate more than 6 minutes, error count is cleared.</p> | | | | | | |

| Block distinction | | Operation of diagnosis function | | | | Action and Judgment |
|---|--------------------------------------|---------------------------------|--|--|---|--|
| Check code | Block | Check code | Cause of operation | Air conditioner status | Display flashing error | |
| 03 | The others (including compressor) | 21 | <p>Return signal of the outdoor unit has been sent when operation start. But after that, signal is stop some time.</p> <ul style="list-style-type: none"> Instantaneous power failure. Some protector (hardware) of the outdoor unit open circuit of signal. Signal circuit of indoor P.C. board or outdoor P.C. board is failure in some period. TE, TC high temperature TE for cooling operation TC for heating operation. | Indoor unit operates continue. Outdoor unit stop. | <p>Flashes when error is detected 18 times*.</p> <p>Flashing stop and outdoor unit start to operate when the return signal from the outdoor unit is normal.</p> | <ol style="list-style-type: none"> Check power supply (Rate $\pm 10\%$) If the air conditioner repeat operate and stop with interval of approx. 10 to 40 minutes. <ul style="list-style-type: none"> Check protector (hardware) such as Hi-Pressure switch, Thermal-Relay, etc. Check refrigerant amount, packed valve opening and any possibility cause which may affect high temperature or high pressure. Check operation signal of the indoor unit by using diode. Measure voltage at terminal block of the indoor unit between No.2 and No.3 (or L2 and S) If signal is varied 15-60V continuously, replace inverter P.C. board. If signal is not varied, replace indoor P.C. board. Check and clean heat exchanger area Indoor and Outdoor unit. |
| <p>* 4, 8 or 18 times ; When first error is detected, error is count as 1 time, then once operation is stop and re-started.</p> <p>After re-starting operation within 6 minutes, if same error is detected, error count is add (count become 2 times)</p> <p>When error count comes 4, 8 or 18 times, record error to check code. But after re-starting operation, if no error is detected and air conditioner can operate more than 6 minutes, error count is cleared.</p> | | | | | | |

11-5. Judgement of Trouble by Every Symptom

11-5-1. Indoor unit (Including remote controller)

(1) Indoor unit is not operated.

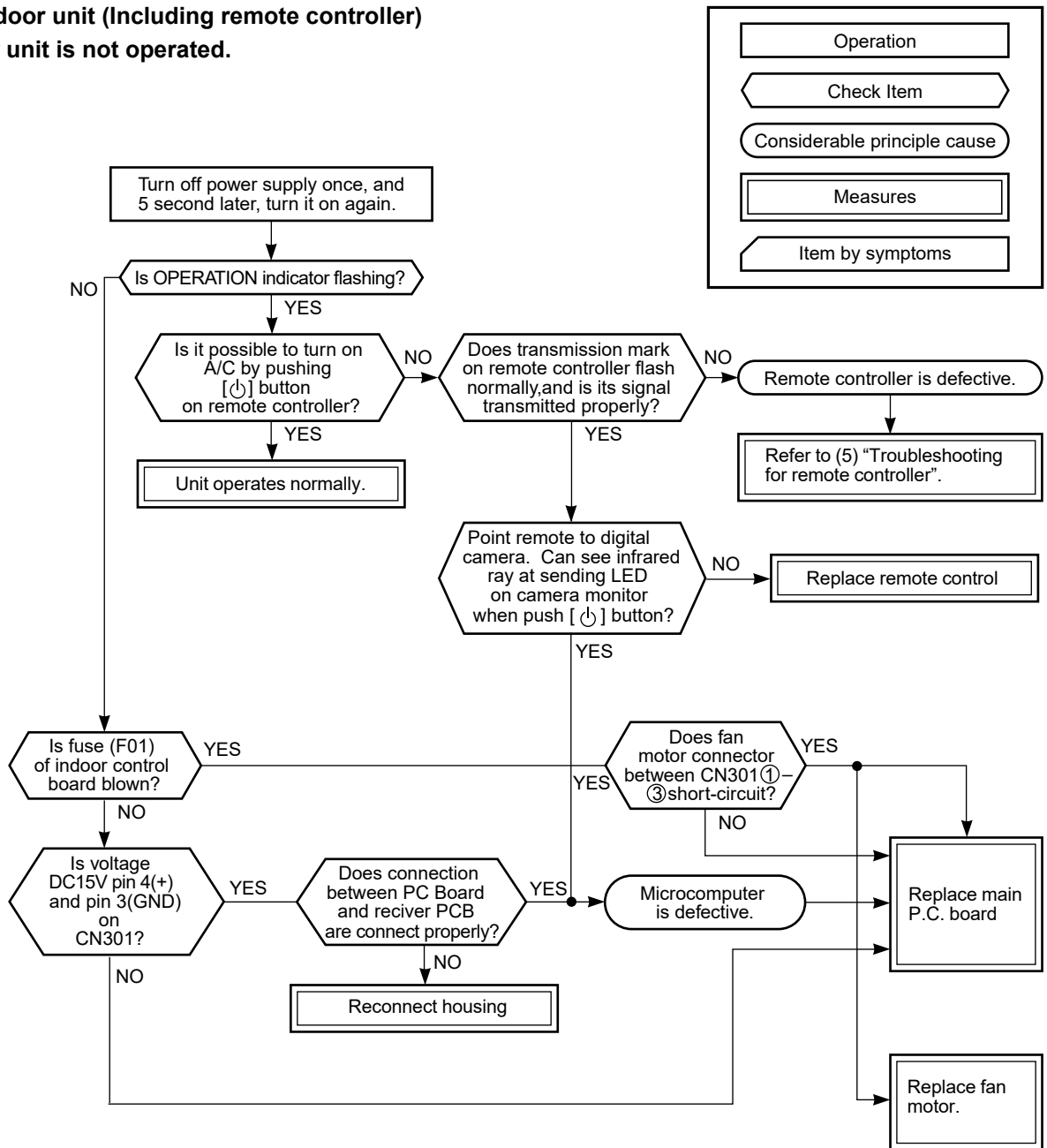

(2) Operation is not turned on though Indoor P.C. board is replaced

<Confirmation procedure>

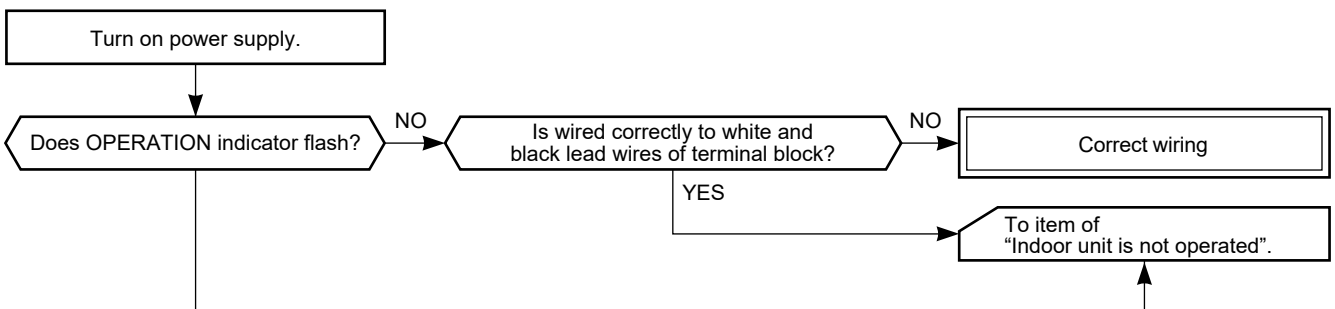

(3) Only the indoor motor fan does not operate

<Primary check>

1. Is it possible to detect the power supply voltage (AC220–240V) between ① and ② on the terminal block?
2. Does the indoor fan motor operate in cooling operation?
(In heating operation, the indoor fan motor does not operate for approximately 10 minutes after it is turned on, to prevent a cold air from blowing in.)

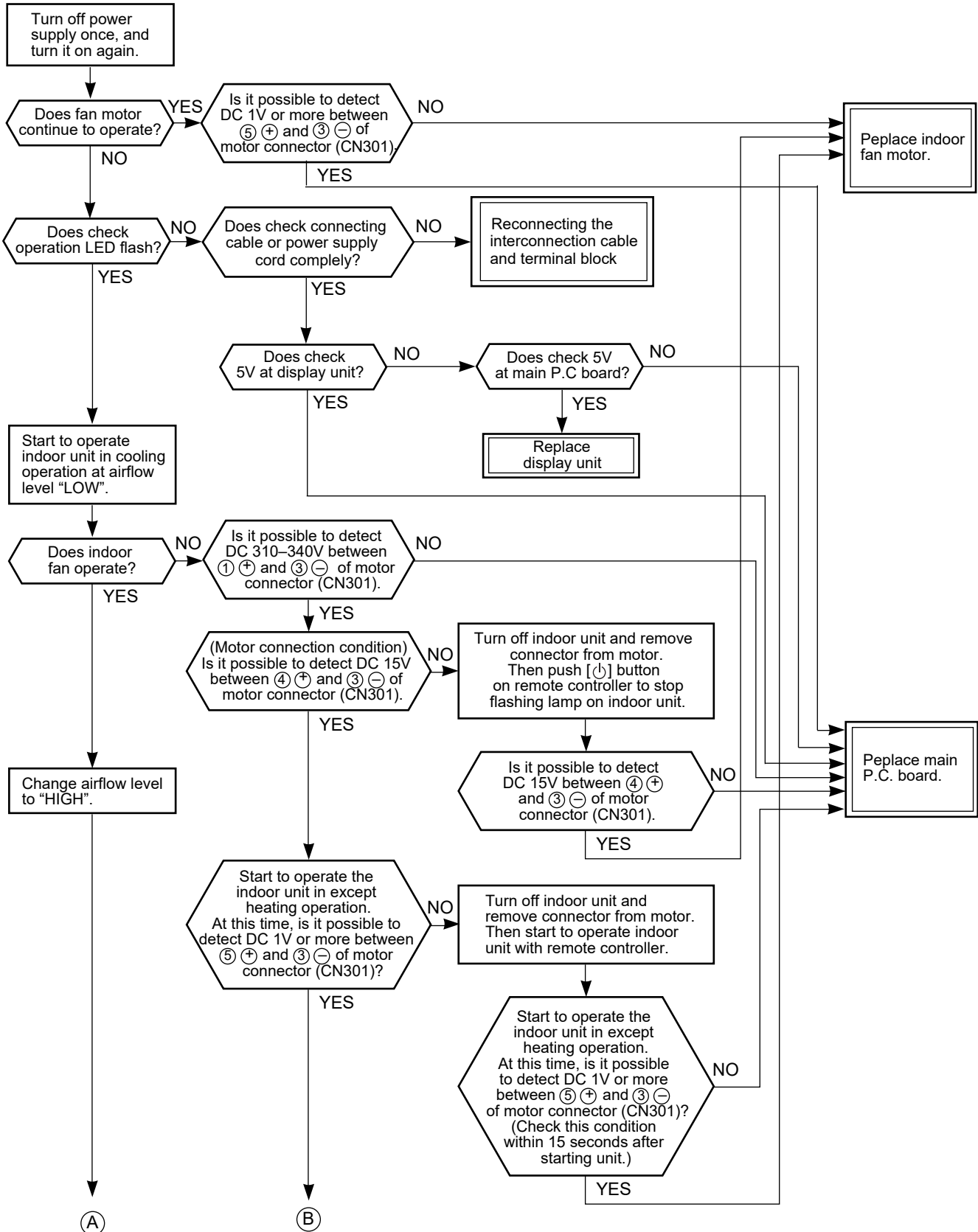

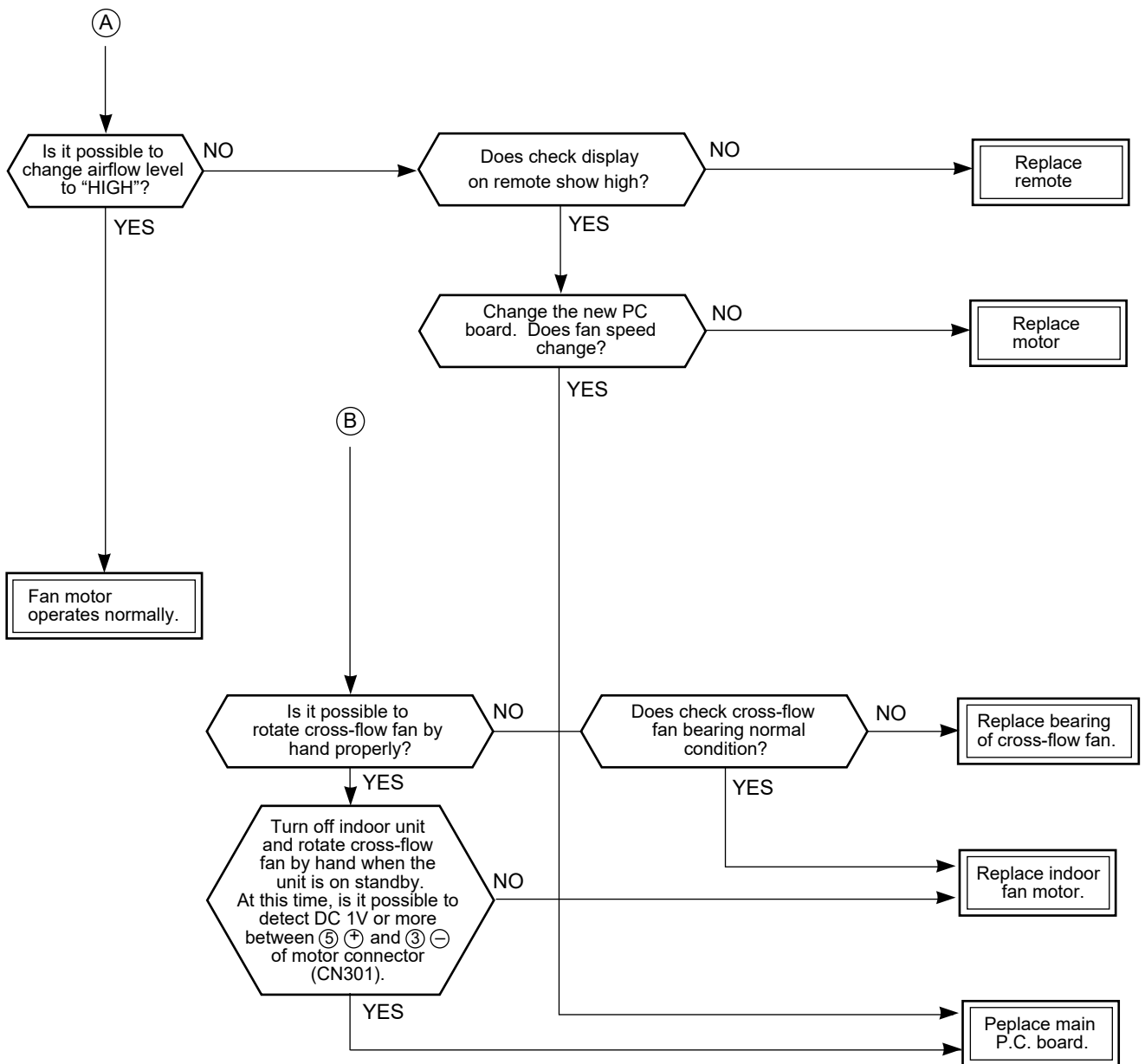

(4) Indoor fan motor automatically starts to rotate by turning on power supply

<Cause>

The IC is built in the indoor fan motor. Therefore the P.C. board is also mounted to inside of the motor. If the P.C. board is soldered imperfectly or the IC is defective, the fan motor may automatically rotate by turning on power supply.

<Inspection procedure>

1. Turn on breaker.
2. After Fan motor operate, off A/C by remote controller.
3. Turn off breaker for a while, then turn it ON.
 - 3.1. If fan motor not operate, it means an unit in Auto-restart operation. (see more detail in P. 45-46)
 - 3.2. If Fan motor still operate, follow the below.
 - 3.2.1. Remove the grille.
 - 3.2.2. Remove the cover terminal by release one screw.
 - 3.2.3. Remove right panel and remove E-box coner.
 - 3.2.4. Check DC voltage with CN301 connector while the fan motor is rotating.

NOTE :

- Do not disconnect the connector while the fan motor is rotating.
- Use a thin test rod.

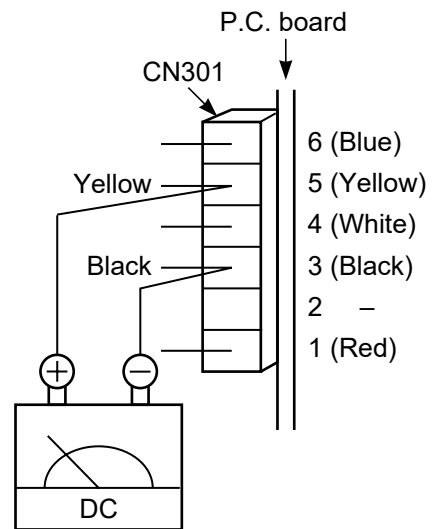
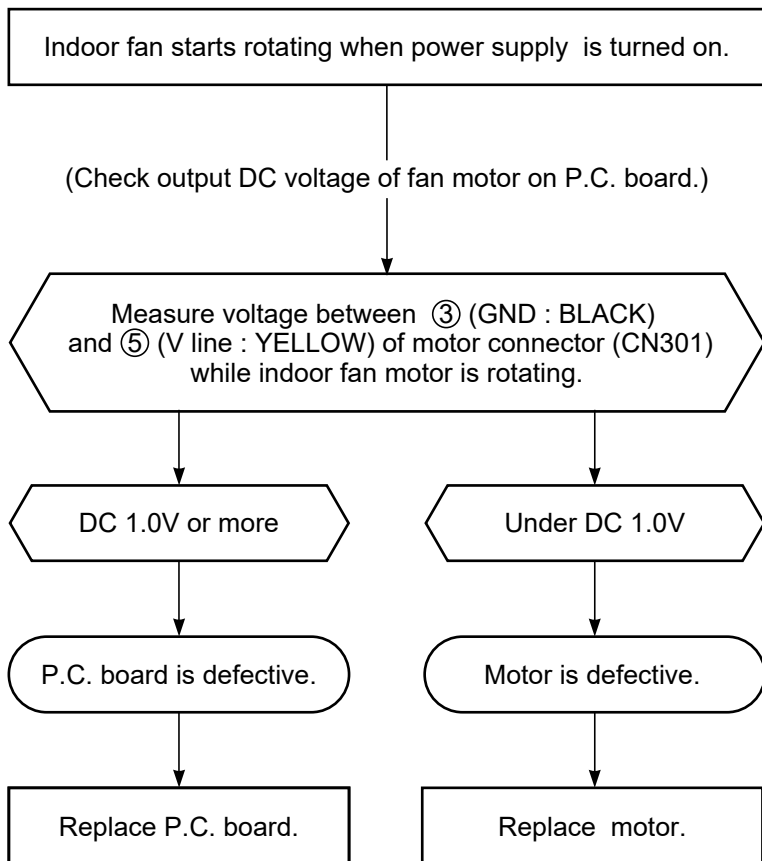

(5) Troubleshooting for remote controller

<Primary check>

Check that A or B selected on the main unit is matched with A or B selected on the remote controller.

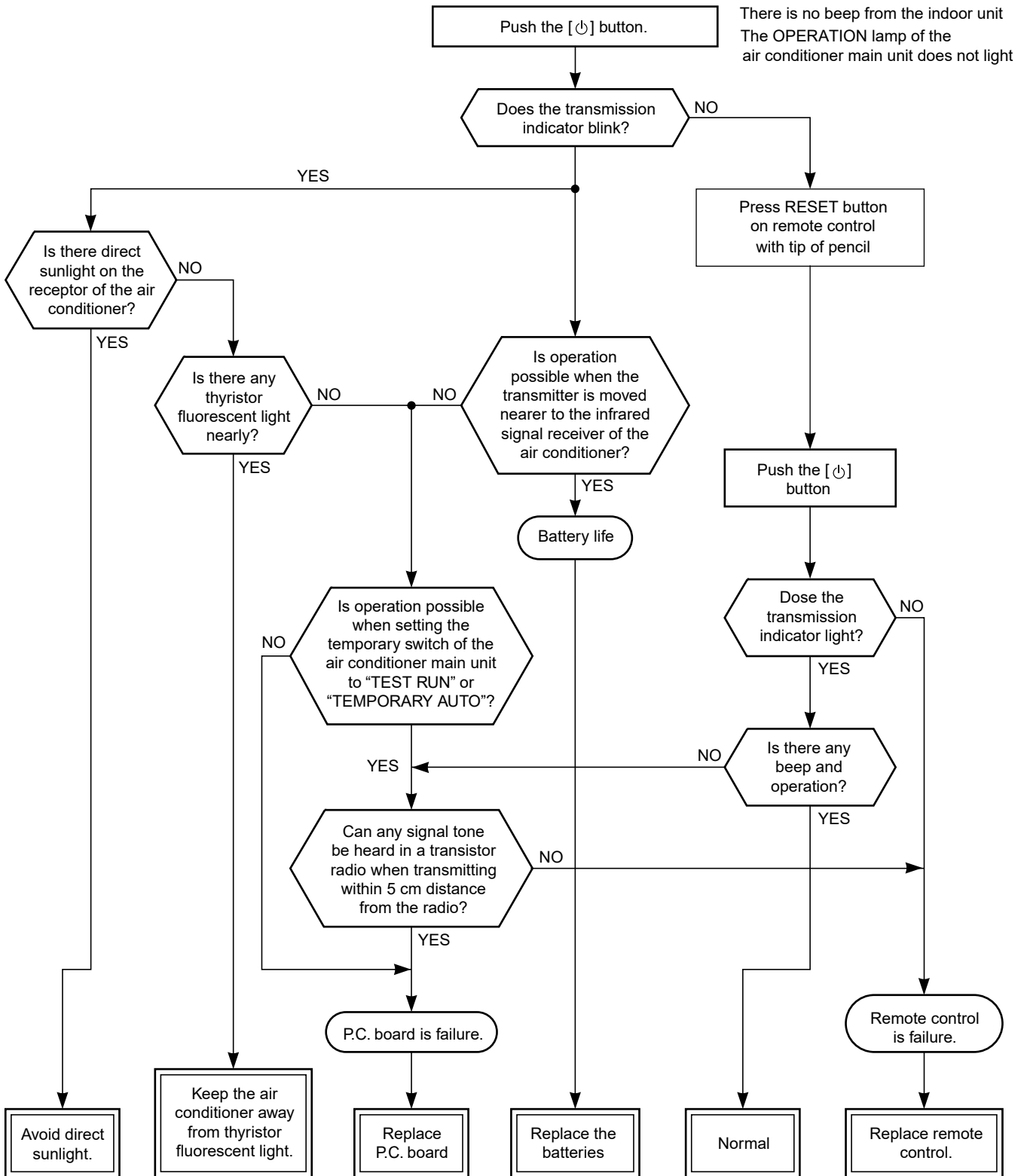

11-5-2. Wiring Failure (Interconnecting and Serial Signal Wire)

(1) Outdoor unit does not operate

1) Is the voltage between ② and ③ of the indoor terminal block varied?

Confirm that transmission from indoor unit to outdoor unit is correctly performed based upon the following diagram.

NOTE:

- Measurement should be performed 2 minutes and 30 seconds after starting of the operation.
- Be sure to prepare a diode for judgment.

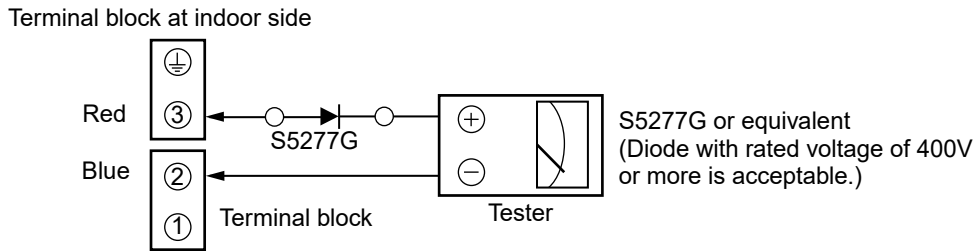

Normal time : Voltage swings between DC15 and 60V. Inverter Assembly check (11-8-1.)

Abnormal time : Voltage does not vary.

(2) Outdoor unit stops in a little while after operation started

<Check procedure> Select phenomena described below.

1) The outdoor unit stops 10 to 20 minutes after operation started, and 10 minutes or more are required to restart the unit.

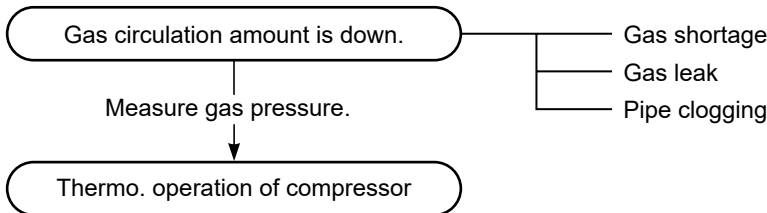

2) If the unit stops once, it does not operate until the power will be turned on again.

To item of Outdoor unit does not operate.

3) The outdoor unit stops 10 minutes to 1 hour after operation started, and an alarm is displayed. (Discharge temp. error check code 03, 1E Sensor temp. error check code 02, 1C)

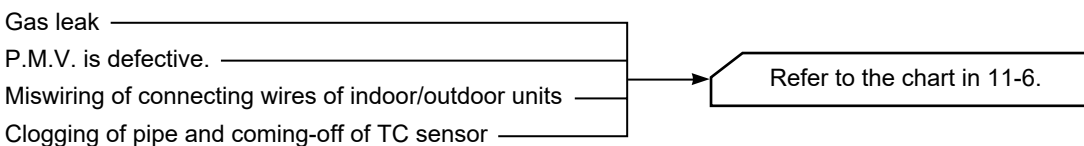

11-6. Check Code 1C (Miswiring in indoor/outdoor units) and 1E

<Check procedure>

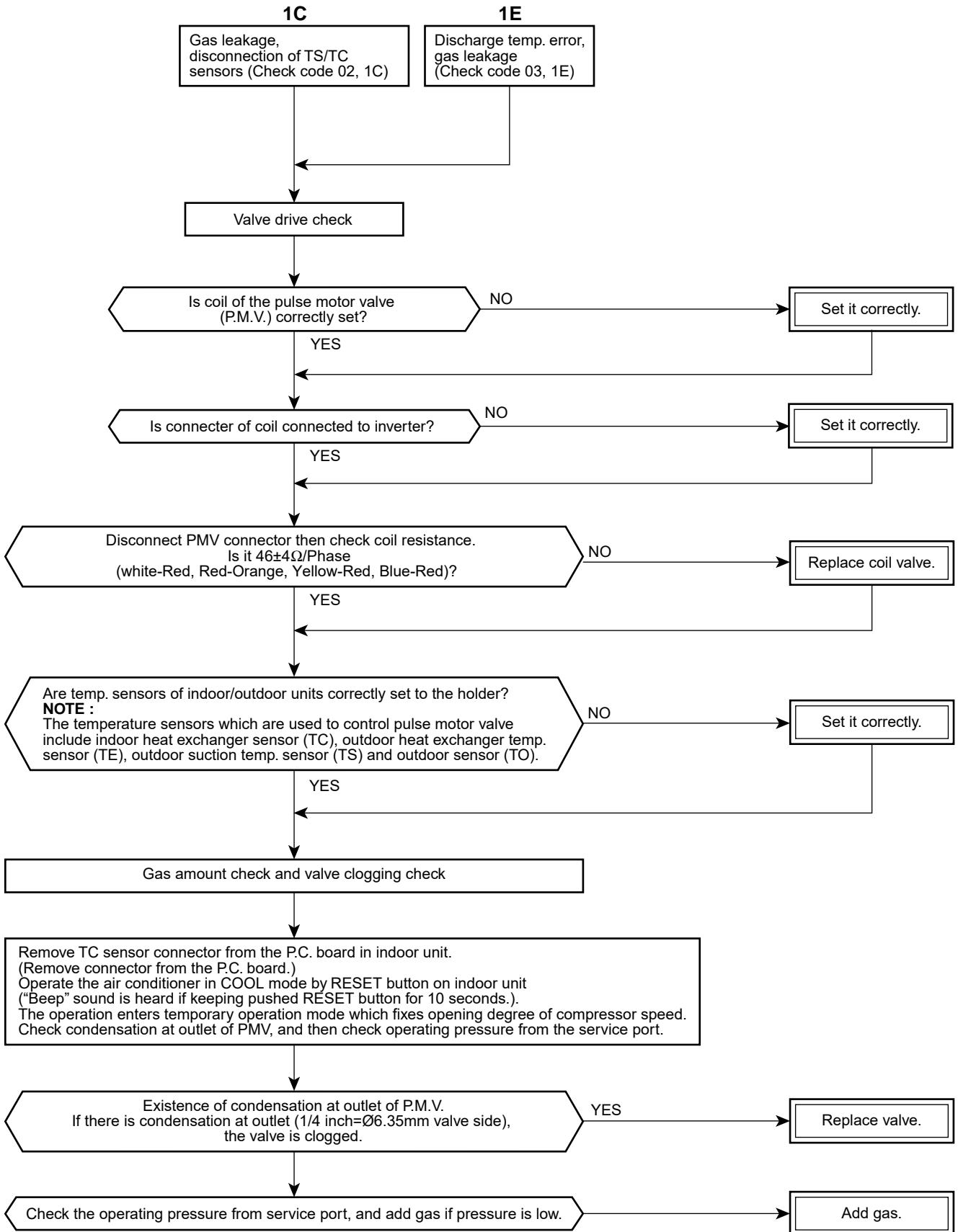

11-7. How to Diagnose Trouble in Outdoor Unit

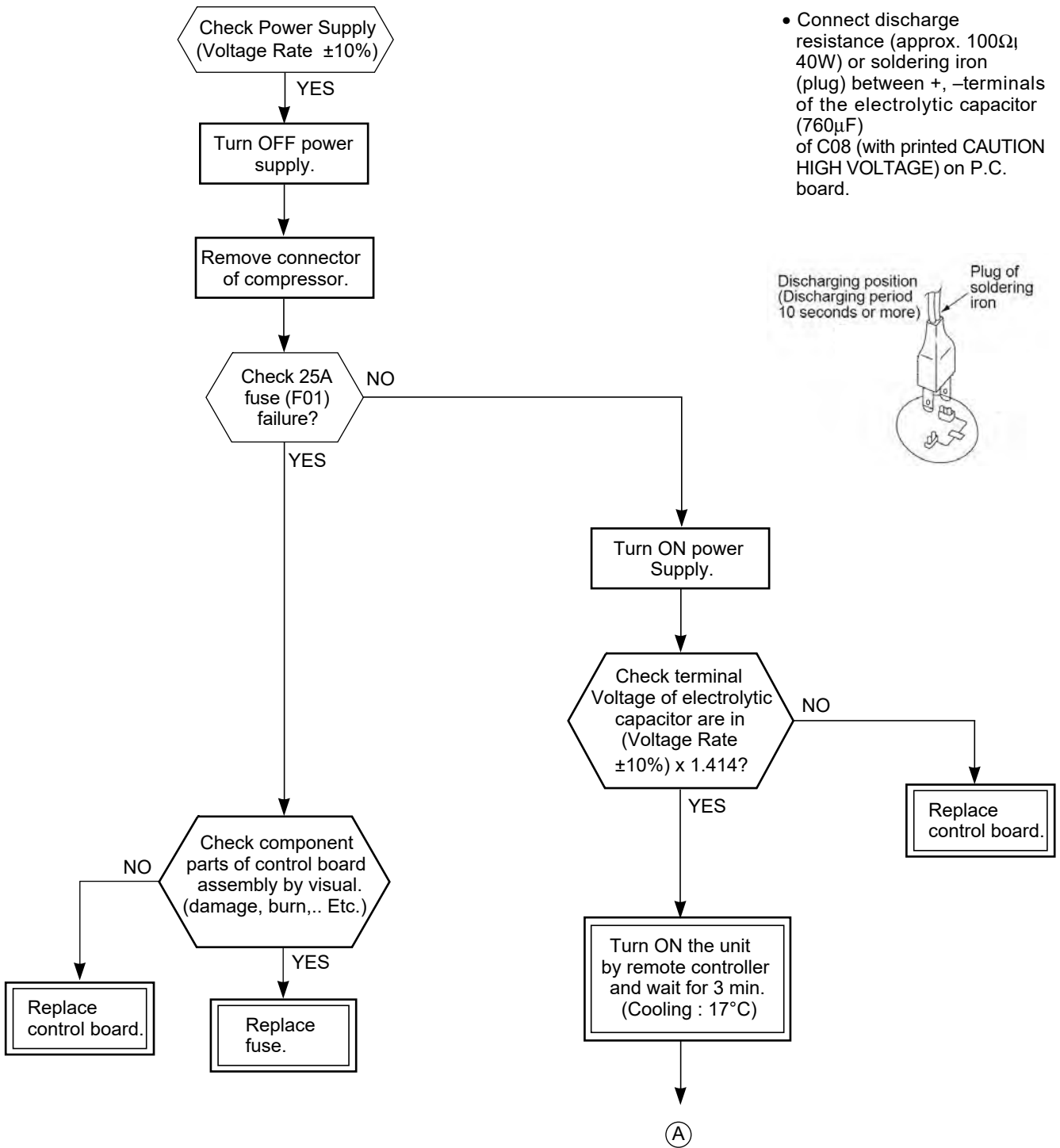

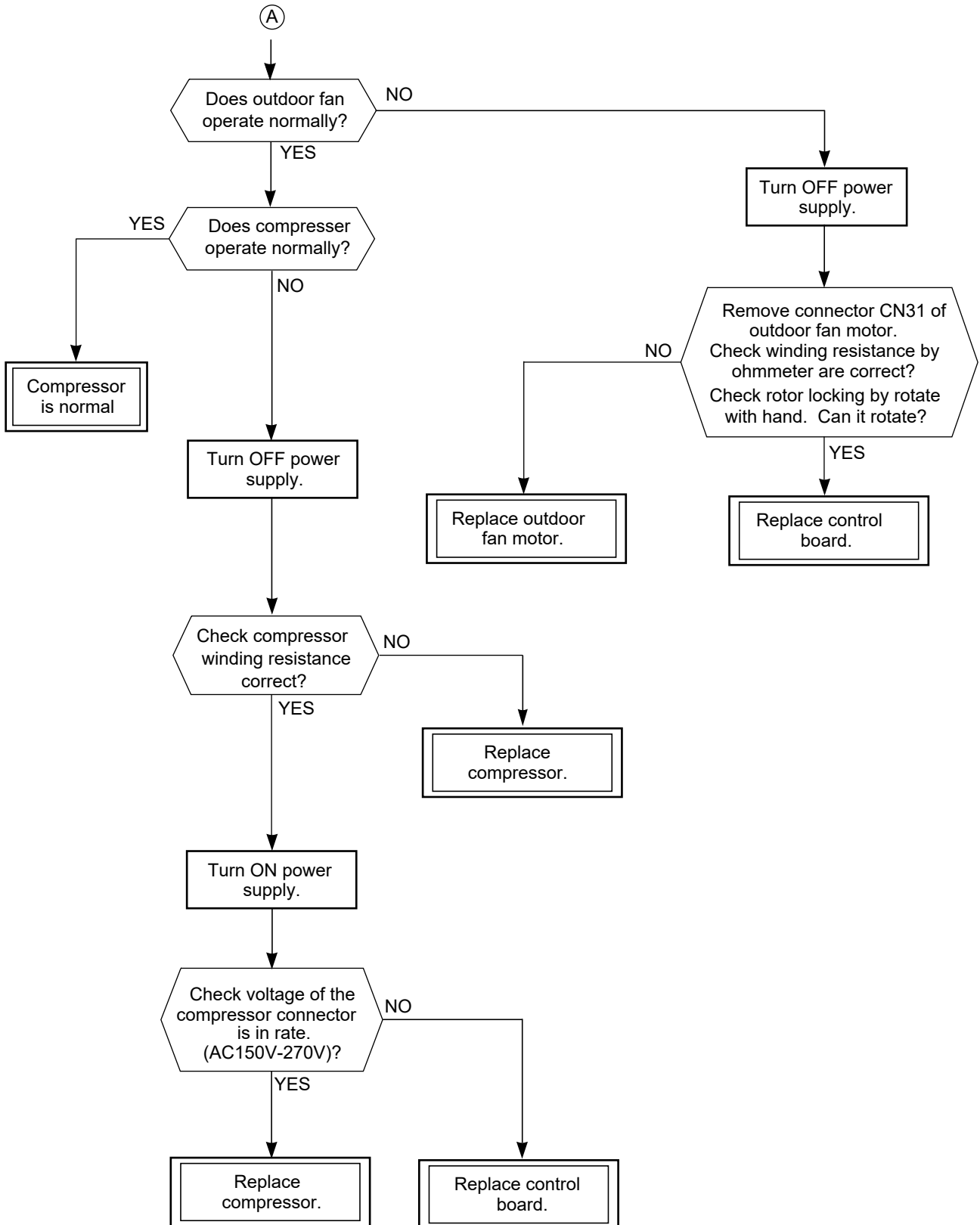

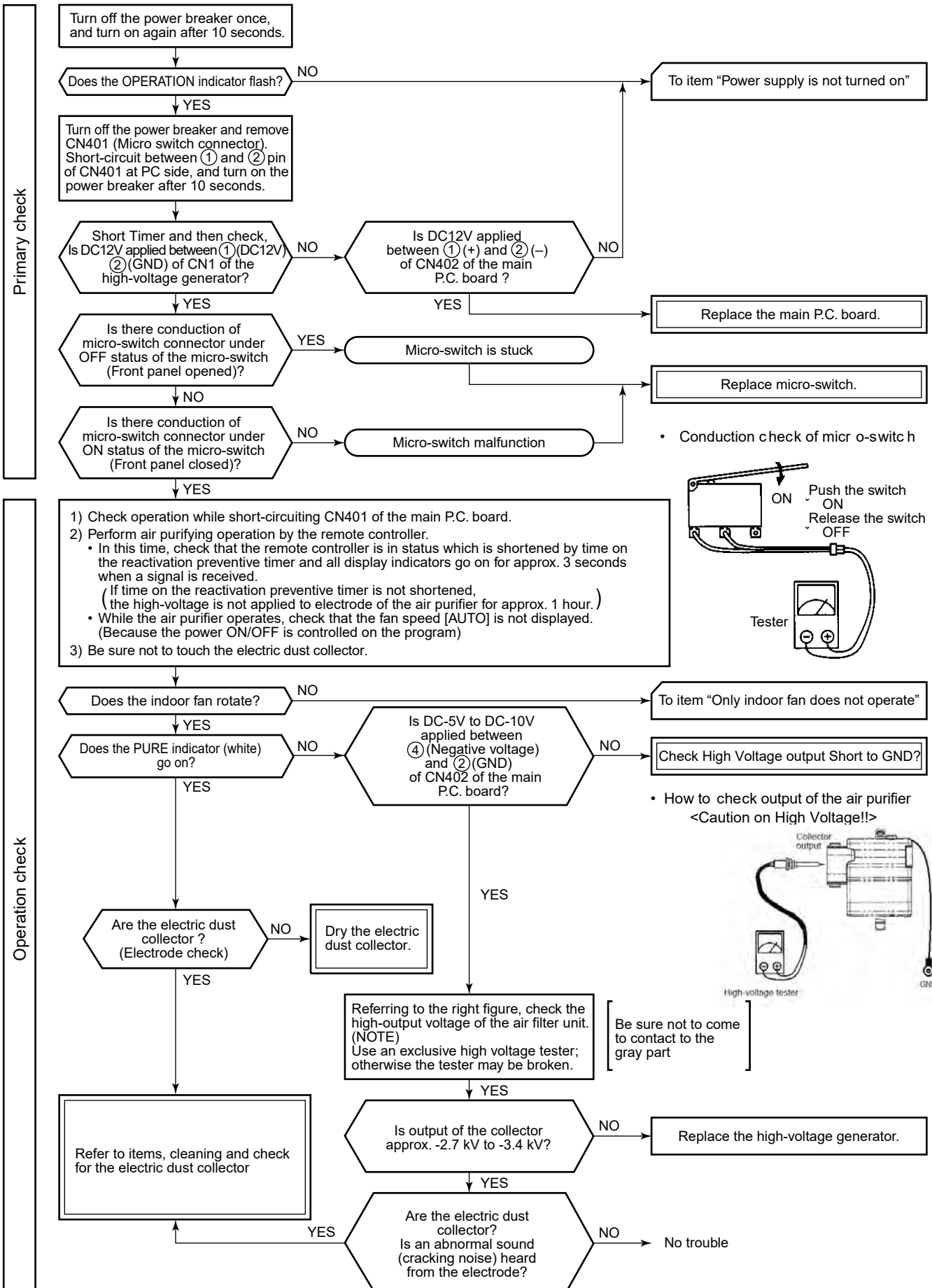

11-8. How to Check Simply the Main Parts (2) Inspection procedures

11-8-1. How to check the P.C. board (Indoor unit)

(1) Operating precautions

- 1) When removing the front panel or the P.C. board, be sure to shut off the power supply breaker.
- 2) When removing the P.C. board, hold the edge of the P.C. board and do not apply force to the parts.
- 3) When connecting or disconnecting the connectors on the P.C. board, hold the whole housing. Do not pull at the lead wire.

11-8-2. How to shorten time for start the compressor.

1. Turn on remote.
2. Setting requirment operation.
3. Push off remote.
4. Press [SET] button while pressing [CHECK] button with a tip of a pencil.
5. Then press [⏻] button to transmit the signal to the indoor unit.

- 1) When a P.C. board is judged to be defective, check for disconnection, burning, or discoloration of the copper foil pattern or this P.C. board.
- 2) The P.C. board consists of the following 3 parts
 - a. **Main P.C. board part:**
DC power supply circuit (5 V, 12 V, 15V)
Indoor fan motor control circuit, CPU and peripheral circuits, buzzer, and Driving circuit of louver.
 - b. **Indication unit circuit**
 - c. **Infrared ray receiving circuit**

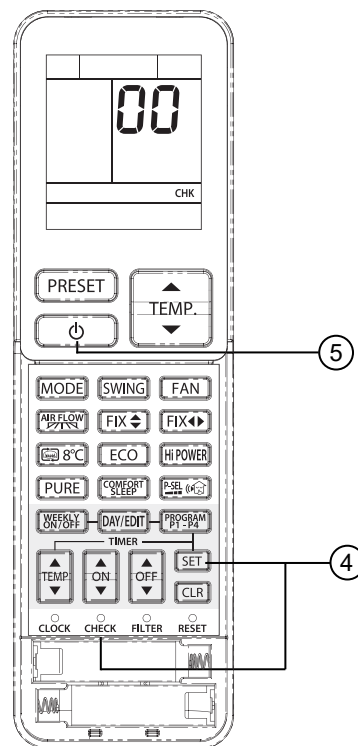

This setting helps to shorten a compressor waiting period when operate cool, heat or dry mode. A compressor suddenly starts one order of Remote controller is received.

11-8-3. P.C. Board Layout

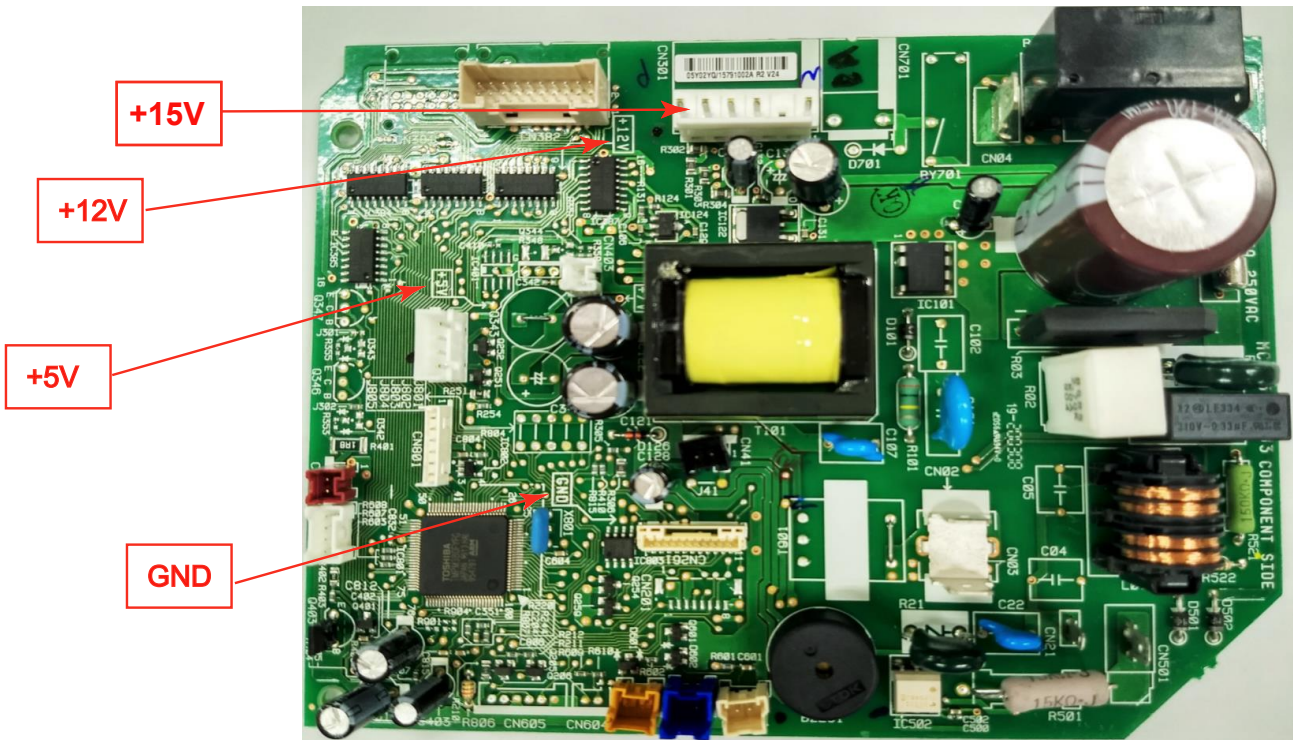

[1] Sensor characteristic table

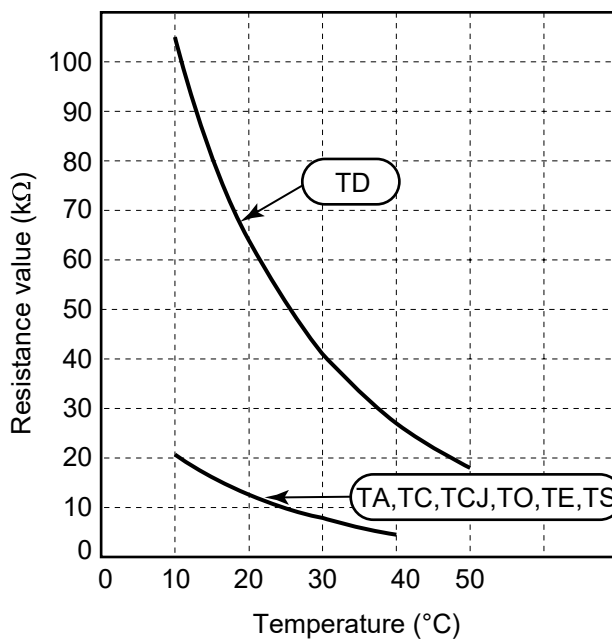

- TD : Discharge temp. sensor
- TA : Room temp. sensor
- TC and TCJ : Heat exchanger temp. sensor
- TO : Outdoor temp. sensor
- TE : Outdoor heat exchanger temp. sensor
- TS : Suction temp. sensor

11-8-4. Indoor Unit (Other Parts)

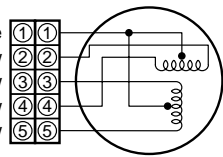
| No. | Part name | Checking procedure | | | | | | | | | | | | | | | | | | |
|------------------|--|--|-------------|------------------|--------|------------|--------|--------|--------|--------|------|------|------|------|------------------|------|------|------|-----|-----|
| 1 | Room temp. (TA) sensor Heat exchanger (TC, TCJ) sensor | Disconnect the connector and measure the resistance value with tester. (Normal temp.) <table border="1" style="margin-left: 20px;"> <thead> <tr> <th style="border: none;">Temperature</th> <th>10°C</th> <th>20°C</th> <th>25°C</th> <th>30°C</th> <th>40°C</th> </tr> </thead> <tbody> <tr> <td style="border: none;">Sensor</td> <td style="border: none;">10°C</td> <td style="border: none;">20°C</td> <td style="border: none;">25°C</td> <td style="border: none;">30°C</td> <td style="border: none;">40°C</td> </tr> <tr> <td style="border: none;">TA, TC, TCJ (kΩ)</td> <td>20.7</td> <td>12.6</td> <td>10.0</td> <td>7.9</td> <td>4.5</td> </tr> </tbody> </table> | Temperature | 10°C | 20°C | 25°C | 30°C | 40°C | Sensor | 10°C | 20°C | 25°C | 30°C | 40°C | TA, TC, TCJ (kΩ) | 20.7 | 12.6 | 10.0 | 7.9 | 4.5 |
| Temperature | 10°C | 20°C | 25°C | 30°C | 40°C | | | | | | | | | | | | | | | |
| Sensor | 10°C | 20°C | 25°C | 30°C | 40°C | | | | | | | | | | | | | | | |
| TA, TC, TCJ (kΩ) | 20.7 | 12.6 | 10.0 | 7.9 | 4.5 | | | | | | | | | | | | | | | |
| 2 | Remote controller | Refer to 11-5-1. (5). | | | | | | | | | | | | | | | | | | |
| 3 | Louver motor MP24Z4N | Measure the resistance value of each winding coil by using the tester. (Under normal temp. 25°C) <div style="display: flex; align-items: center; margin-left: 20px;"> <div style="margin-right: 10px;"> White ①① Yellow ②② Yellow ③③ Yellow ④④ Yellow ⑤⑤ </div>  <table border="1" style="margin-left: 20px;"> <thead> <tr> <th>Position</th> <th>Resistance value</th> </tr> </thead> <tbody> <tr> <td>1 to 2</td> <td rowspan="5" style="text-align: center; vertical-align: middle;">200Ω ± 14Ω</td> </tr> <tr> <td>1 to 3</td> </tr> <tr> <td>1 to 4</td> </tr> <tr> <td>1 to 5</td> </tr> <tr> <td>1 to 5</td> </tr> </tbody> </table> <div style="margin-left: 20px; text-align: right;">at 25°C</div> </div> | Position | Resistance value | 1 to 2 | 200Ω ± 14Ω | 1 to 3 | 1 to 4 | 1 to 5 | 1 to 5 | | | | | | | | | | |
| Position | Resistance value | | | | | | | | | | | | | | | | | | | |
| 1 to 2 | 200Ω ± 14Ω | | | | | | | | | | | | | | | | | | | |
| 1 to 3 | | | | | | | | | | | | | | | | | | | | |
| 1 to 4 | | | | | | | | | | | | | | | | | | | | |
| 1 to 5 | | | | | | | | | | | | | | | | | | | | |
| 1 to 5 | | | | | | | | | | | | | | | | | | | | |
| 4 | Indoor fan motor | Refer to 11-5-1. (3) and (4). | | | | | | | | | | | | | | | | | | |

11-8-5. Outdoor Unit

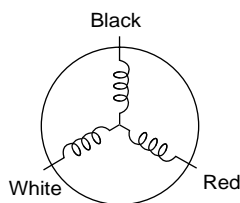
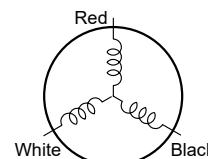
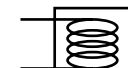
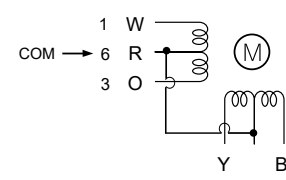
| 1 | Compressor RAS-25N4AVPG-ND Model : KTN150D63UFZ3 RAS-35N4AVPG-ND Model : KTM180D68UFZ | Measure the resistance value of each winding by using the tester. <div style="display: flex; align-items: center; margin-left: 20px;">  <table border="1" style="margin-left: 20px;"> <thead> <tr> <th rowspan="2">Position</th> <th colspan="2">Resistance value</th> </tr> <tr> <th>KTN150D63UFZ3</th> <th>KTM180D68UFZ</th> </tr> </thead> <tbody> <tr> <td>Red - White</td> <td rowspan="3" style="text-align: center; vertical-align: middle;">1.02Ω</td> <td rowspan="3" style="text-align: center; vertical-align: middle;">1.82Ω</td> </tr> <tr> <td>White - Black</td> </tr> <tr> <td>Black - Red</td> </tr> </tbody> </table> <div style="margin-left: 20px; text-align: right;">at 20°C</div> </div> | Position | Resistance value | | KTN150D63UFZ3 | KTM180D68UFZ | Red - White | 1.02Ω | 1.82Ω | White - Black | Black - Red | | | | | | | | | | | | | | | | | | |
|-------------------------|--|--|-------------------------|----------------------------------|-------------|---------------|---------------|-------------|--------------|----------|---------------|-------------|------|------|------|------|---------|-----|----|----|----|----|----|-----------------|------|------|------|-----|-----|---|
| Position | Resistance value | | | | | | | | | | | | | | | | | | | | | | | | | | | | | |
| | KTN150D63UFZ3 | KTM180D68UFZ | | | | | | | | | | | | | | | | | | | | | | | | | | | | |
| Red - White | 1.02Ω | 1.82Ω | | | | | | | | | | | | | | | | | | | | | | | | | | | | |
| White - Black | | | | | | | | | | | | | | | | | | | | | | | | | | | | | | |
| Black - Red | | | | | | | | | | | | | | | | | | | | | | | | | | | | | | |
| 2 | Fan motor | Measure the resistance value of winding by using the tester. <div style="display: flex; align-items: center; margin-left: 20px;">  <table border="1" style="margin-left: 20px;"> <thead> <tr> <th>Position</th> <th>Resistance value</th> </tr> </thead> <tbody> <tr> <td>Red - White</td> <td rowspan="3" style="text-align: center; vertical-align: middle;">18.8 ± 2Ω</td> </tr> <tr> <td>White - Black</td> </tr> <tr> <td>Black - Red</td> </tr> </tbody> </table> <div style="margin-left: 20px; text-align: right;">at 20°C</div> </div> | Position | Resistance value | Red - White | 18.8 ± 2Ω | White - Black | Black - Red | | | | | | | | | | | | | | | | | | | | | | |
| Position | Resistance value | | | | | | | | | | | | | | | | | | | | | | | | | | | | | |
| Red - White | 18.8 ± 2Ω | | | | | | | | | | | | | | | | | | | | | | | | | | | | | |
| White - Black | | | | | | | | | | | | | | | | | | | | | | | | | | | | | | |
| Black - Red | | | | | | | | | | | | | | | | | | | | | | | | | | | | | | |
| 3 | 4-Way valve coil | Measure the resistance value of winding by using the tester. <div style="display: flex; align-items: center; margin-left: 20px;">  <table border="1" style="margin-left: 20px;"> <tr> <td>Model : STF-H01AJ1872A1</td> <td>Resistance value : 1725 ± 172.5Ω</td> </tr> </table> <div style="margin-left: 20px; text-align: right;">at 20°C</div> </div> | Model : STF-H01AJ1872A1 | Resistance value : 1725 ± 172.5Ω | | | | | | | | | | | | | | | | | | | | | | | | | | |
| Model : STF-H01AJ1872A1 | Resistance value : 1725 ± 172.5Ω | | | | | | | | | | | | | | | | | | | | | | | | | | | | | |
| 4 | Pulse Modulating Valve (PMV) coil Model : PQ-M10012-000313 | Measure the resistance value of winding by using the tester. <div style="display: flex; align-items: center; margin-left: 20px;">  <table border="1" style="margin-left: 20px;"> <thead> <tr> <th>Position</th> <th>Resistance value</th> </tr> </thead> <tbody> <tr> <td>Red - White</td> <td style="text-align: center;">46 to 4Ω</td> </tr> <tr> <td>Red - Orange</td> <td style="text-align: center;">46 to 4Ω</td> </tr> <tr> <td>Gray- Yellow</td> <td style="text-align: center;">46 to 4Ω</td> </tr> <tr> <td>Gray- Blue</td> <td style="text-align: center;">46 to 4Ω</td> </tr> </tbody> </table> <div style="margin-left: 20px; text-align: right;">at 20°C</div> </div> | Position | Resistance value | Red - White | 46 to 4Ω | Red - Orange | 46 to 4Ω | Gray- Yellow | 46 to 4Ω | Gray- Blue | 46 to 4Ω | | | | | | | | | | | | | | | | | | |
| Position | Resistance value | | | | | | | | | | | | | | | | | | | | | | | | | | | | | |
| Red - White | 46 to 4Ω | | | | | | | | | | | | | | | | | | | | | | | | | | | | | |
| Red - Orange | 46 to 4Ω | | | | | | | | | | | | | | | | | | | | | | | | | | | | | |
| Gray- Yellow | 46 to 4Ω | | | | | | | | | | | | | | | | | | | | | | | | | | | | | |
| Gray- Blue | 46 to 4Ω | | | | | | | | | | | | | | | | | | | | | | | | | | | | | |
| 5 | Outside air temp. sensor (TO) Discharge temp. sensor (TD) Suction temp. sensor (TS) Exchanger temp. sensor (TE) | Disconnect the connector, and measure resistance value with the tester. (Normal temperature) <table border="1" style="margin-left: 20px;"> <thead> <tr> <th style="border: none;">Temperature</th> <th>10°C</th> <th>20°C</th> <th>25°C</th> <th>30°C</th> <th>40°C</th> <th>50°C</th> </tr> </thead> <tbody> <tr> <td style="border: none;">Sensor</td> <td style="border: none;">10°C</td> <td style="border: none;">20°C</td> <td style="border: none;">25°C</td> <td style="border: none;">30°C</td> <td style="border: none;">40°C</td> <td style="border: none;">50°C</td> </tr> <tr> <td style="border: none;">TD (kΩ)</td> <td>100</td> <td>64</td> <td>50</td> <td>41</td> <td>27</td> <td>18</td> </tr> <tr> <td style="border: none;">TO, TS, TE (kΩ)</td> <td>20.7</td> <td>12.6</td> <td>10.0</td> <td>7.9</td> <td>4.5</td> <td>—</td> </tr> </tbody> </table> | Temperature | 10°C | 20°C | 25°C | 30°C | 40°C | 50°C | Sensor | 10°C | 20°C | 25°C | 30°C | 40°C | 50°C | TD (kΩ) | 100 | 64 | 50 | 41 | 27 | 18 | TO, TS, TE (kΩ) | 20.7 | 12.6 | 10.0 | 7.9 | 4.5 | — |
| Temperature | 10°C | 20°C | 25°C | 30°C | 40°C | 50°C | | | | | | | | | | | | | | | | | | | | | | | | |
| Sensor | 10°C | 20°C | 25°C | 30°C | 40°C | 50°C | | | | | | | | | | | | | | | | | | | | | | | | |
| TD (kΩ) | 100 | 64 | 50 | 41 | 27 | 18 | | | | | | | | | | | | | | | | | | | | | | | | |
| TO, TS, TE (kΩ) | 20.7 | 12.6 | 10.0 | 7.9 | 4.5 | — | | | | | | | | | | | | | | | | | | | | | | | | |

11-8-6. Checking Method for Each Part

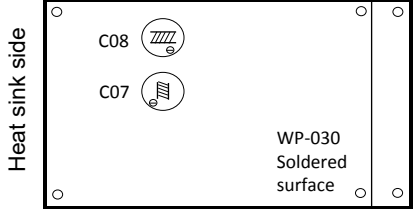
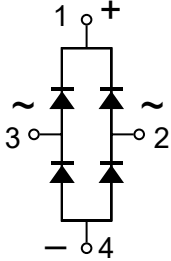
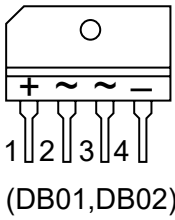
| No. | Part name | Checking procedure | | | | | | | | | | | | |
|------------|--|--|------------|--|----------------------------------|---|---|---|-----|-----|-----|-----|-----|-----|
| 1 | Electrolytic capacitor (For boost, smoothing) | <ol style="list-style-type: none"> 1. Turn OFF the power supply breaker. 2. Discharge all two capacitors completely. 3. Check that safety valve at the bottom of capacitor is not broken. 4. Check that vessel is not swollen or exploded. 5. Check that electrolytic liquid does not blow off. 6. Check that the normal charging characteristics are shown in continuity test by the tester. <div style="display: flex; justify-content: space-around; align-items: center;"> <div style="text-align: center;">  <p>Heat sink side</p> <p>C08</p> <p>C07</p> <p>WP-030 Soldered surface</p> <p>C07, C08 → 760μF</p> </div> <div style="border: 1px solid black; padding: 5px; width: 200px;"> <p style="text-align: center;">Case that product is good</p> <p>Pointer swings once, and returns slowly. When performing test once again under another polarity, the pointer should return.</p> </div> </div> | | | | | | | | | | | | |
| 2 | Diode block | <ol style="list-style-type: none"> 1. Turn OFF the power supply breaker. 2. Completely discharge the two electrolytic capacitors. 3. Remove the diode block from the PCB (which is soldered in place). 4. Use a multimeter with a pointer to test the continuity, and check that the diode block has the proper rectification characteristics. <div style="display: flex; justify-content: space-around; align-items: center;"> <div style="text-align: center;">  </div> <div style="text-align: center;">  <p>(DB01, DB02)</p> </div> <table border="1" style="border-collapse: collapse; text-align: center;"> <thead> <tr> <th colspan="2" data-bbox="997 920 1177 981">Tester rod</th> <th data-bbox="1182 920 1422 981">Resistance value in good product</th> </tr> </thead> <tbody> <tr> <td data-bbox="997 981 1086 1032">+</td> <td data-bbox="1091 981 1177 1032">-</td> <td data-bbox="1182 981 1422 1211" rowspan="4">∞</td> </tr> <tr> <td data-bbox="997 1032 1086 1084">~ 2</td> <td data-bbox="1091 1032 1177 1084">+ 1</td> </tr> <tr> <td data-bbox="997 1084 1086 1135">~ 3</td> <td data-bbox="1091 1084 1177 1135">~ 2</td> </tr> <tr> <td data-bbox="997 1135 1086 1211">- 4</td> <td data-bbox="1091 1135 1177 1211">~ 3</td> </tr> </tbody> </table> <p style="text-align: right; margin-top: 10px;">10 to 20 Ω when the multimeter probe is reversed</p> </div> | Tester rod | | Resistance value in good product | + | - | ∞ | ~ 2 | + 1 | ~ 3 | ~ 2 | - 4 | ~ 3 |
| Tester rod | | Resistance value in good product | | | | | | | | | | | | |
| + | - | ∞ | | | | | | | | | | | | |
| ~ 2 | + 1 | | | | | | | | | | | | | |
| ~ 3 | ~ 2 | | | | | | | | | | | | | |
| - 4 | ~ 3 | | | | | | | | | | | | | |

11-9. How to Simply Judge Whether Outdoor Fan Motor is Good or Bad

1. Symptom

- Outdoor fan motor does not rotate.
- Outdoor fan motor stops within several tens seconds though it started rotating.
- Outdoor fan motor rotates or does not rotate according to the position where the fan stopped, etc.

Remote controller check code "02 : Outdoor block, 1A : Outdoor fan drive system error"

2. Cause

The following causes are considered when the outdoor fan motor does not normally rotate.

- 1) Mechanical lock of the outdoor fan motor
- 2) Winding failure of the outdoor fan motor
- 3) Position-detect circuit failure inside of the outdoor fan motor
- 4) Motor drive circuit failure of the outdoor P.C. board

3. How to simply judge whether outdoor fan motor is good or bad

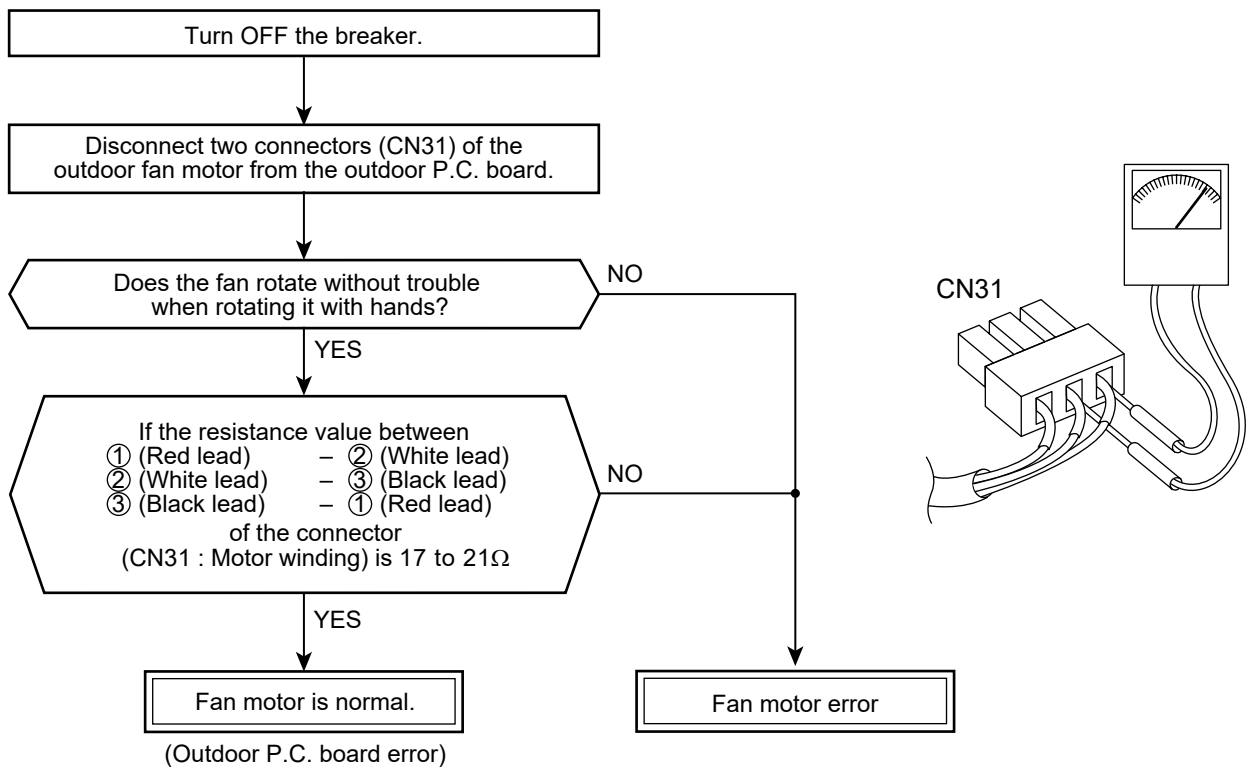

NOTE :

However, GND circuit error inside of the motor may be accepted in some cases when the above check is performed.



When the fan motor does not become normal even if P.C. board is replaced, replace the outdoor fan motor.

12. HOW TO REPLACE THE MAIN PARTS

WARNING



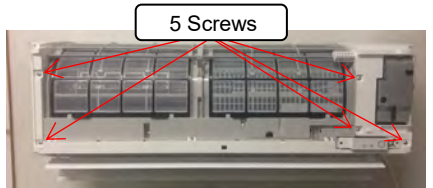

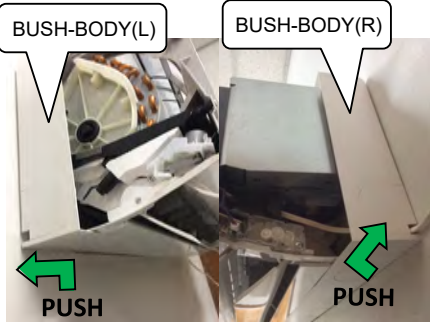
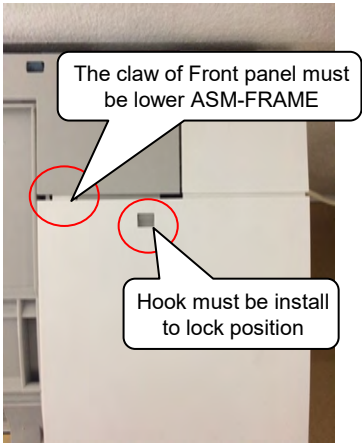
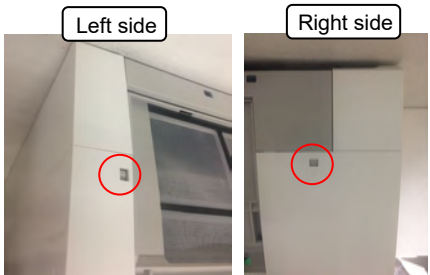
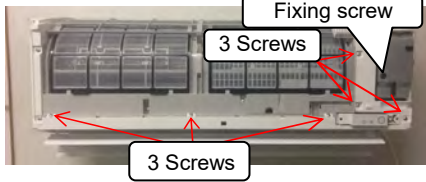
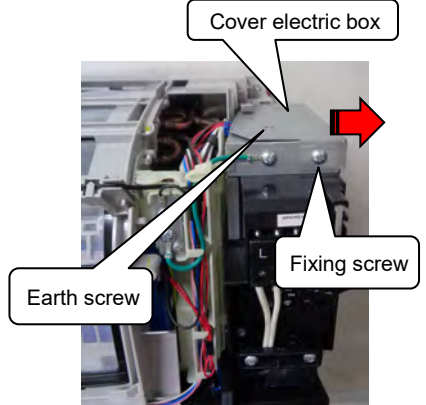

- Since high voltages pass through the electrical parts, turn off the power without fail before proceeding with the repairs.
Electric shocks may occur if the power plug is not disconnected.
- After the repairs have been completed (after the front panel and cabinet have been installed), perform a test run, and check for smoking, unusual sounds and other abnormalities.
If this check is omitted, a fire and/or electric shocks may occur.
Before proceeding with the test run, install the front panel and cabinet.
- Ensure that the following steps are taken when doing repairs on the refrigerating cycle.
 1. Do not allow any naked flames in the surrounding area.
If a gas stove or other appliance is being used, extinguish the flames before proceeding.
If the flames are not extinguished, they may ignite any oil mixed with the refrigerant gas.
 2. Do not use welding equipment in an airtight room.
Carbon monoxide poisoning may result if the room is not properly ventilated.
 3. Do not bring welding equipment near flammable objects.
Flames from the equipment may cause the flammable objects to catch fire.
- **If keeping the power on is absolutely unavoidable while doing a job such as inspecting the circuitry, wear rubber gloves to avoid contact with the live parts.**
Electric shocks may be received if the live parts are touched.
High-voltage circuits are contained inside this unit.
Proceed very carefully when conducting checks since directly touching the parts on the control circuit board may result in electric shocks.

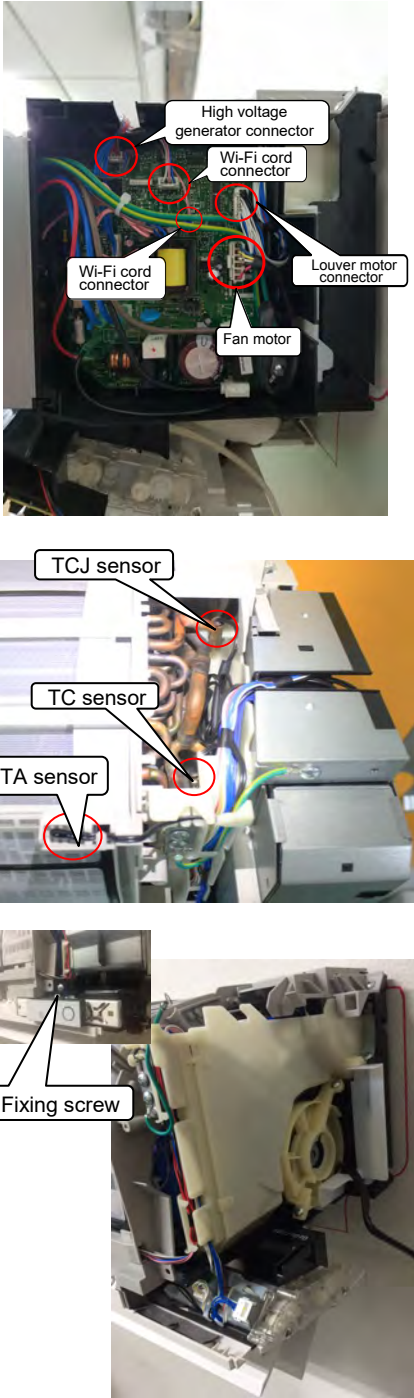
12-1. Indoor Unit

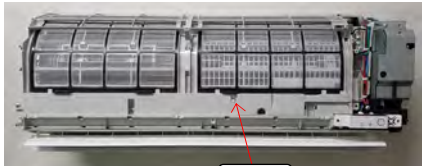

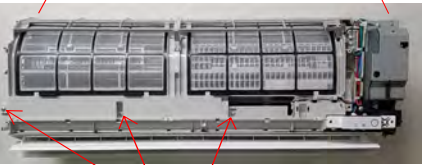
| No. | Part name | Work procedure | Remarks |
|-----|-------------|--|---|
| ① | Front panel | 1) Stop operation of the air conditioner and turn off its main power supply. 2) Open the air inlet grill, push the arm toward the outside, and remove the grill. 3) Remove the left and the right air filters. 4) Remove the fixing screws (5 pcs.) 5) Open LOUVER-HR as the picture then pull down and pull outward PANEL-FR (R) and PANEL-FR(L) as picture |    |

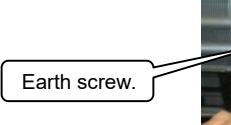
| No. | Part name | Work procedure | Remarks |
|------------|----------------------------------|--|--|
| ② ③ | BUSH-BODY(R) BUSH-BODY(L) | 1) Push the bottom of part and slide to the right side. 1) Push the bottom of part and slide to the left side. <Point to note during re-assemble Front panel> - Please make sure that the claw of Front-panel insert below edge of ASM-FRAME. - Hooks in left and right side must be install to lock position |    |
| ④ | Electric parts box assembly. | 1) Stop operation of the air conditioner and turn off its main power supply. 2) Open the air inlet grill, push the arm toward the outside, and remove the grille. 3) Remove the fixing screw at PANEL-FR(R) 3pcs, at PLATE-DECO 3 pcs. following picture then pull out PANEL-FR (R) and PLATE-DECO. 4) Remove a fixing screw and Cover-connector assembly, then remove Power-supply cord after already remove fixing-screws (2pcs.) at cord-clamp. 5) Remove the fixing screw that secure the cover electric box, then remove cover electric box toward right side. 6) Remove the screws of Earth-lead that fixing at the electronic box. |   |

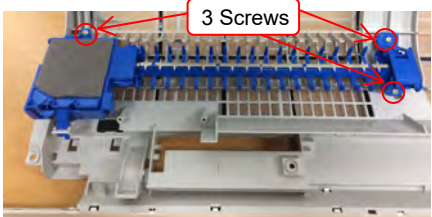
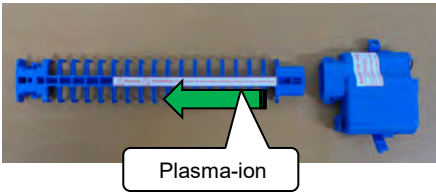
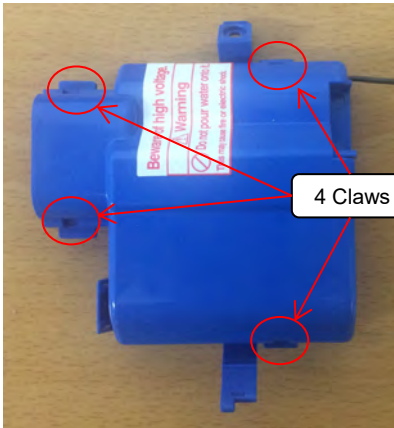
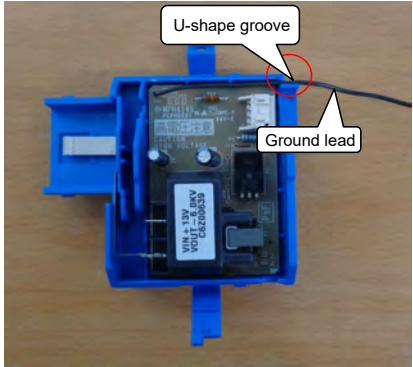

| No. | Part name | Work procedure | Remarks |
|-----|------------------------------|---|--|
| ④ | Electric parts box assembly. | <p>7) Disconnect the connector of fan-motor, louver-motor and high voltage generator and cord Wi-Fi connector.</p> <p>8) Pull out TCJ sensor from sensor holder of the evaporator. Pull out TC sensor from sensor holder of the evaporator. Remove TA sensor form sensor holder.</p> <p>9) Remove fixing screw that hold electronic part, then remove electronic parts.</p> <p><How to assemble the electric parts box></p> <p>1) Lock the top of electric box with hook of Frame-up and secure it by fixing screw with Back-body. After that connect the connector of High-voltage-generator, Fan-motor and Louver-motor.</p> <p>2) Insert TA/TC/TCJ sensor into holder-sensor. Fix the grounding-lead with fixing screw.</p> |  |

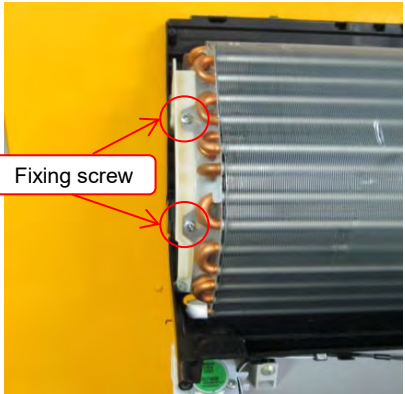
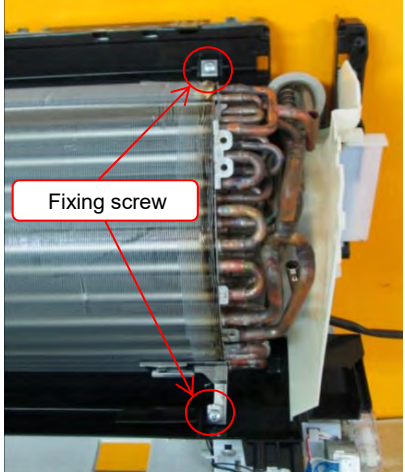
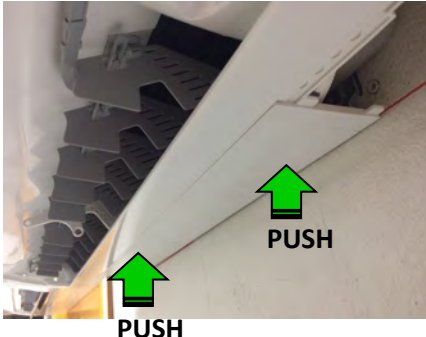
| No. | Part name | Work procedure | Remarks |
|-----|-------------------|---|---|
| ⑤ | Frame | <p>1) Follow to the procedure ① - ④</p> <p>2) Remove the fixing screws at COVER-WIFI 1 Pcs. than take off wifi-cord out from hook lock.</p> <p>3) Remove the Fixing screws at ASM-FRAME (5 Pcs).</p> <p>4) Remove screw of earth lead on plate earth.</p> <p>5) Take off 5 hooks from rear side then remove Frame assembly.</p> <p>6) Remove a fixing screw of ground lead then remove Earth assembly.</p> <p><How to assemble the Frame></p> <p>1) Press the top of Frame with 5 hooks of Back-body</p> <p>2) Fix Frame by 5 fixing screws.</p> |  <p>1 Screw</p>  <p>2 Screws</p>  <p>3 Screws</p>  <p>Earth screw</p>  <p>5 hooks from rear</p>  <p>Earth screw.</p>  |
| ⑥ | Horizontal louver | <p>1) Remove shaft of the horizontal louver from the back body. (First remove the center shaft, and then remove the other shafts.)</p> |  |

| No. | Part name | Work procedure | Remarks |
|-----|---|--|--|
| ⑦ | Plasma-ion charger, High volt generator | <p>1) Follow to the procedure in the item ⑤</p> <p>2) Remove 3 screws and remove the ion-charger assembly from the frame.</p> <p>3) Remove the Plasma-ion charger from the High volt generator assembly.</p> <p>4) Remove cover of HV generator by unlock 4 claws.</p> <p>5) Remove the board of HV generator.</p> <p><Points to note during re-installation></p> <ul style="list-style-type: none"> - Lay the wires straight, such that they pass through the earth wire in a U-shape. - Lay the wires such that the high voltage power supply line passes in a U-shape. |  <p>3 Screws</p>  <p>Plasma-ion</p>  <p>4 Claws</p>  <p>U-shape groove</p> <p>Ground lead</p> |

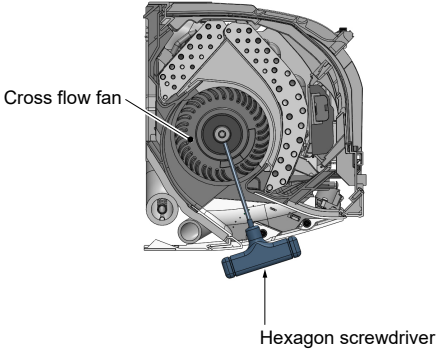
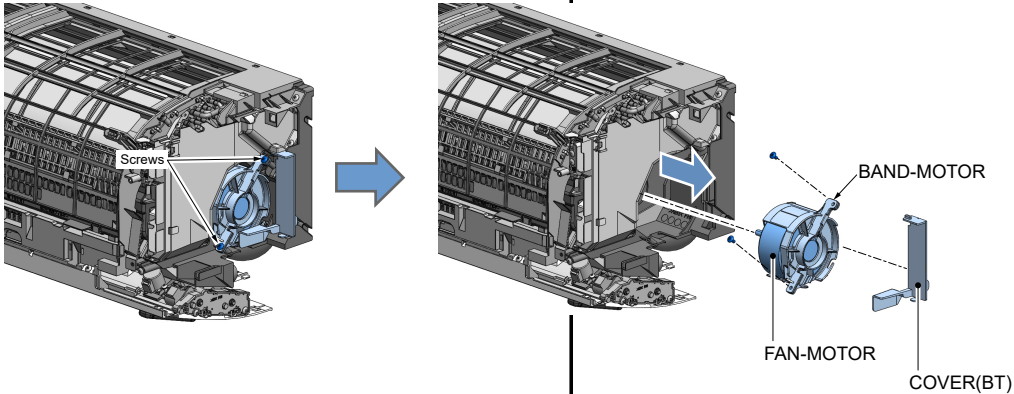
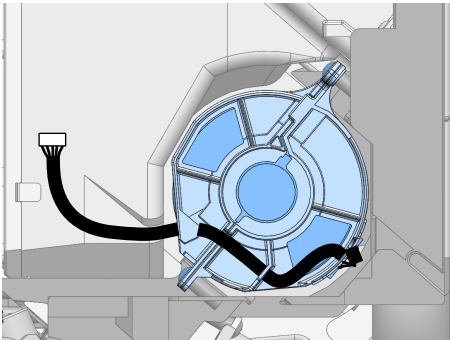
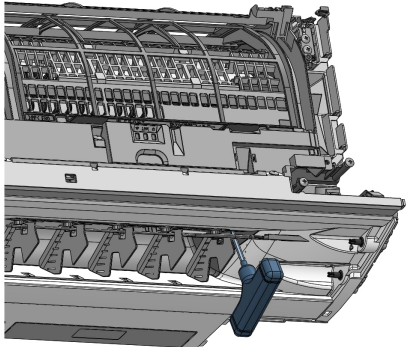
| No. | Part name | Work procedure | Remarks |
|-----|--------------------------------|--|--|
| ⑧ | Evaporator (Heat exchanger) | <p>1) Follow the procedure in item ① - ⑥</p> <p>2) Remove 2 fixing screws at the left side of the end plate of the heat exchanger.</p> <p>3) Remove 2 fixing screws on the right side of heat exchanger.</p> <p>4) Move unit from the wall by pushing at point as picture and lift up the unit.</p> <p>5) Rotate unit to back side, then remove the Pipe-holder from the main unit.</p> <p>6) Rotate the main unit, then pull out the Heatexchanger from the Back-body as picture.</p> |      |

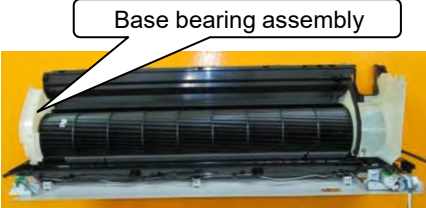
| No. | Part name | Work procedure | Remarks |
|-----|-----------|---|---|
| ⑨ | Fan motor | <p>1) Follow the procedure in item ① - ④ and ⑥</p> <p>2) Loosen the set screw of the cross flow fan.</p>  <p>3) Remove COVER(BT) and 2 fixing screws of the motor band.</p> <p>4) Pull the motor band and the fan motor outward.</p>  <p><To re-installation> - Keep connector position and arrange fan motor wire follow figure.</p>  |  |

| No. | Part name | Work procedure | Remarks |
|-----|-----------|---|--|
| ⑩ | Bearing | <p>1) Follow to the procedure in the item ① - ⑥ and ⑧ - ⑨</p> <p>2) Remove 2 fixing screws from the Base bearing assembly, then remove Base bearing assembly from the main unit.</p> <p><Caution at assembling> - If the bearing is out from the housing, push it into the specified position and then incorporate it in the main body.</p> |     |

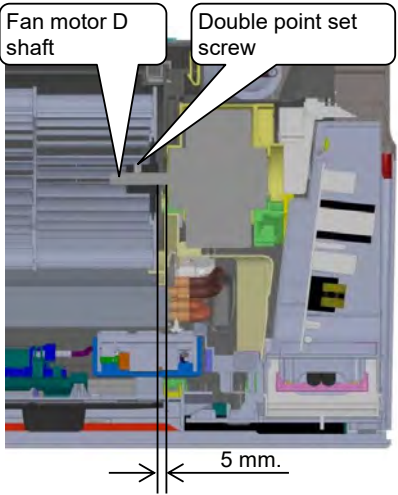
| No. | Part name | Work procedure | Remarks |
|-----|----------------|---|---|
| 11 | Cross flow fan | <p><Caution at reassembling></p> <p>1) To incorporate the Fan-motor incorporate the Motor into the position in the following figure, and then install the Fan-motor</p> <ul style="list-style-type: none"> - Install the cross flow fan so that the right end of the 1st joint from the right of the Cross flow fan is set keeping 5.0mm from closed wall of the main unit. - Holding the set screw, install the cross flow fan so that flat area on shaft of the fan motor comes to the mounting hole of the set screw. - Perform positioning of the fan motor as follow: - When assembling the fan motor, the fan motor must be installed in such a way that the fan motor leads will be taken out is positioned at the bottom front. - After assembling the two hooking claws of the motor band(right) into the main body, position the fan motor, insert it, and then secure the motor band(right) using the two fixing screws. |  <p>Fan motor D shaft</p> <p>Double point set screw</p> <p>5 mm.</p> |

12-2. Outdoor Unit

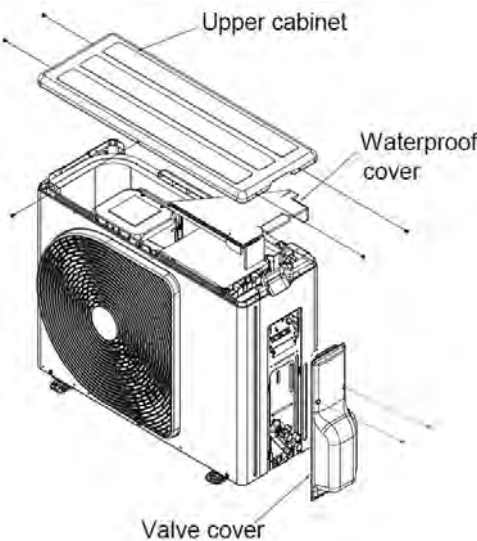
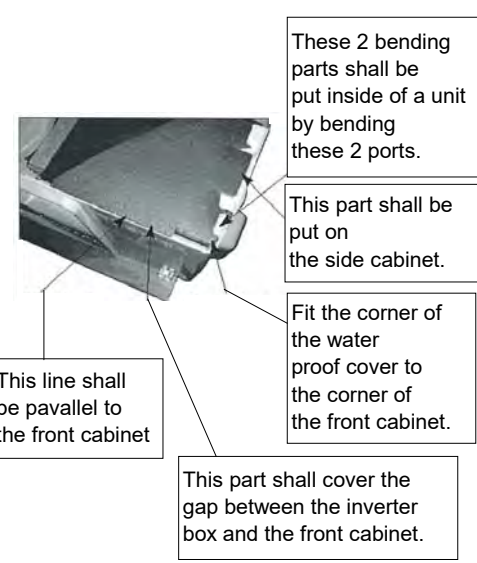
| No. | Part name | Procedure | Remarks |
|-----|------------------|---|---|
| ① | Common procedure | <p>1. Detachment</p> <div style="border: 1px solid black; padding: 5px; margin: 10px 0;"> <p style="text-align: center;">NOTE</p> <p>Wear gloves for this job. Otherwise, you may injure your hands on the parts, etc.</p> </div> <ol style="list-style-type: none"> 1) Stop operation of the air conditioner, and turn off the main switch of the breaker for air conditioner. 2) Remove the valve cover. (ST2TØ4 × 10L 2 pcs.) <ul style="list-style-type: none"> • After removing screw, remove the valve cover pulling it downward. 3) Remove cord clamp (ST2TØ4 × 14L 3 pcs.), and then remove connecting cable. 4) Remove the upper cabinet. (ST1TØ4 × 10L 5 pcs.) <ul style="list-style-type: none"> • After removing screws, remove the upper cabinet pulling it upward. <p>2. Attachment</p> <ol style="list-style-type: none"> 1) Attach the water-proof cover. <div style="border: 1px solid black; padding: 5px; margin: 10px 0;"> <p style="text-align: center;">NOTE</p> <p>The water-proof cover must be attached without fail in order to prevent rain water, etc. from entering inside the indoor unit.</p> </div> <ol style="list-style-type: none"> 2) Attach the upper cabinet. (ST2TØ4 × 10L 5 pcs.) 3) Perform cabling of connecting cable, and attach the cord clamp. <ul style="list-style-type: none"> • Fix the cord clamp by tightening the screws (ST2TØ 4 x 14L 3 pcs.), fitting 2 concave parts of the cord clamp to each connecting cables. 4) Attach the valve cover. (ST2TØ4 x 10L 3 pcs.) <ul style="list-style-type: none"> • Insert the upper part into the square hole of the side cabinet, set hook claws of the valve cover to square holes (at three positions) of the main unit, and attach it pushing upward, |  <p style="text-align: center;">Upper cabinet</p> <p style="text-align: right;">Waterproof cover</p> <p style="text-align: center;">Valve cover</p>  <div style="border: 1px solid black; padding: 2px; width: fit-content; margin: 5px;"> <p>These 2 bending parts shall be put inside of a unit by bending these 2 ports.</p> </div> <div style="border: 1px solid black; padding: 2px; width: fit-content; margin: 5px;"> <p>This part shall be put on the side cabinet.</p> </div> <div style="border: 1px solid black; padding: 2px; width: fit-content; margin: 5px;"> <p>Fit the corner of the water proof cover to the corner of the front cabinet.</p> </div> <div style="border: 1px solid black; padding: 2px; width: fit-content; margin: 5px;"> <p>This line shall be pavallel to the front cabinet</p> </div> <div style="border: 1px solid black; padding: 2px; width: fit-content; margin: 5px;"> <p>This part shall cover the gap between the inverter box and the front cabinet.</p> </div> <div style="border: 1px solid black; padding: 5px; text-align: center; margin-top: 10px;"> <p>How to mount the water-proof cover</p> </div> |

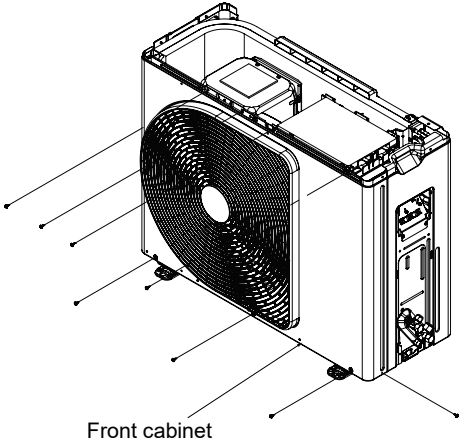
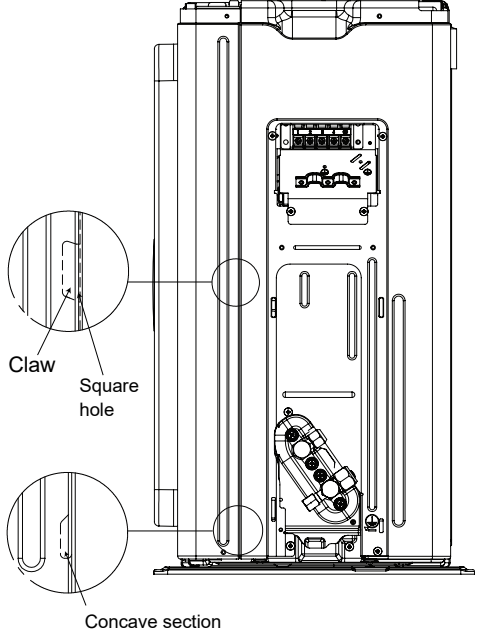
| No. | Part name | Procedure | Remarks |
|-----|---------------|--|--|
| ② | Front cabinet | <p>1. Detachment</p> <ol style="list-style-type: none"> 1) Perform step 1 in ①. 2) Remove the fixing screws (ST2TØ4 × 10L 2 pcs.) used to secure the front cabinet and inverter cover, the screws (ST2TØ4 × 10L 4 pcs.) used to secure the front cabinet at the bottom, and the fixing screws (ST2TØ4 × 10L 2 pcs.) used to secure the motor base. <ul style="list-style-type: none"> • The front cabinet is fitted into the side cabinet (left) at the front left side so pull up the top of the front cabinet to remove it. <p>2. Attachment</p> <ol style="list-style-type: none"> 1) Insert the claw on the front left side into the side cabinet (left). 2) Hook the bottom part of the front right side onto the concave section of the bottom plate. Insert the claw of the side cabinet (right) into the square hole in the front cabinet. 3) Return the screws that were removed above to their original positions and attach them. |  <p style="text-align: center;">Front cabinet</p>  <p style="text-align: center;">Claw Square hole</p> <p style="text-align: center;">Concave section</p> |

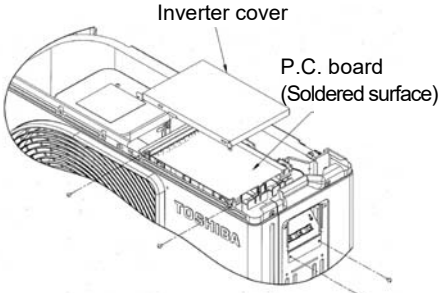
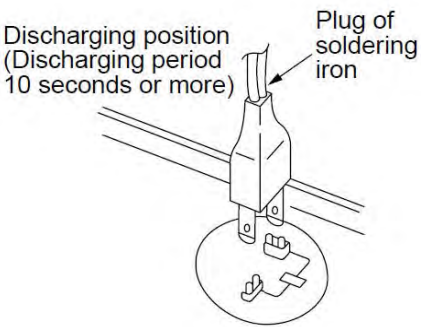
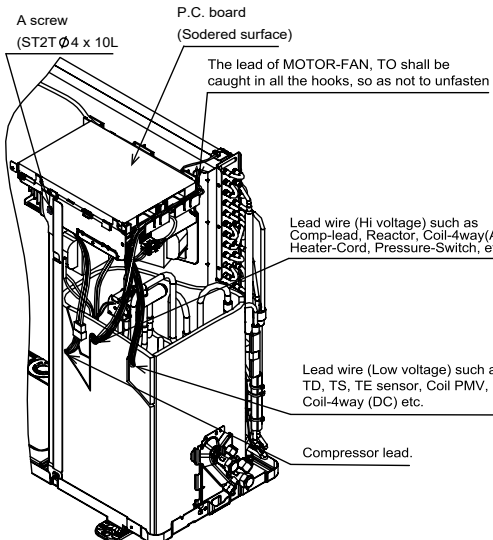
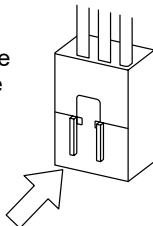
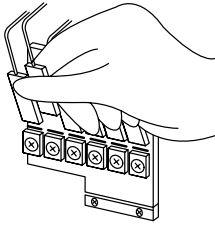
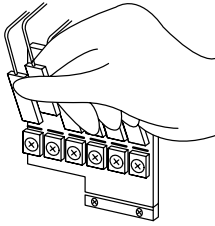
| No. | Part name | Procedure | Remarks |
|-----|-------------------|--|--|
| ③ | Inverter assembly | <p>1) Perform work of item 1 in ①.</p> <p>2) Remove screw (ST2TØ4 × 10L 2 pcs.) of the upper part of the front cabinet.</p> <ul style="list-style-type: none"> • If removing the inverter cover in this condition, P.C. board can be checked. • If there is no space above the unit, perform work of 1 in ②. <div style="border: 1px solid black; padding: 5px; margin: 10px 0;"> <p>Be careful to check the inverter because high-voltage circuit is incorporated in it.</p> </div> <p>3) Perform discharging by connecting ⊕, ⊖ polarity by discharging resistance (approx. 100Ω40W) or plug of soldering iron to ⊕, ⊖ terminals a of the C10 (printed "CAUTION HIGH VOLTAGE" is attached.) electrolytic capacitor (760μF) on P.C. board.</p> <div style="border: 1px solid black; padding: 5px; margin: 10px 0;"> <p>Be careful to discharge the capacitor because the electrolytic capacitor cannot naturally discharge and voltage remains according to trouble type in some cases.</p> </div> <div style="text-align: center; margin: 10px 0;"> <p>NOTE</p> <p>This capacitor is one with mass capacity. Therefore, it is dangerous that a large spark generates if short-circuiting between ⊕, ⊖</p> </div> <p>4) Remove screw (ST2TØ4 × 10L 4pcs.) fixing the terminal part of inverter box to the main body.</p> <p>5) Remove the front cabinet by performing step 1 in ②, and remove the fixing screws (ST2TØ4 × 10L) for securing the main body and inverter box.</p> <p>6) Remove various lead wires from the holder at upper part of the inverter box.</p> <p>7) Pull the inverter box upward.</p> <p>8) Disconnect connectors of various lead wires.</p> <div style="border: 1px solid black; padding: 5px; margin: 10px 0;"> <p style="text-align: center;">Requirement</p> <p>As each connector has a lock mechanism, avoid to remove the connector by holding the lead wire, but by holding the connector.</p> </div> |  <p>Inverter cover P.C. board (Soldered surface)</p>  <p>Discharging position (Discharging period 10 seconds or more) Plug of soldering iron</p>  <p>A screw (ST2TØ4 x 10L) P.C. board (Soldered surface) The lead of MOTOR-FAN, TO shall be caught in all the hooks, so as not to unfasten</p>  <p>Lead wire (Hi voltage) such as Comp-lead, Reactor, Coil-4way(AC), Heater-Cord, Pressure-Switch, etc. Lead wire (Low voltage) such as TD, TS, TE sensor, Coil PMV, Coil-4way (DC) etc. Compressor lead.</p>  <p>The connector is one with lock, so remove it while pushing the part indicated by an arrow.</p>  <p>Be sure to remove the connector by holding the connector, not by pulling the lead wire.</p> |

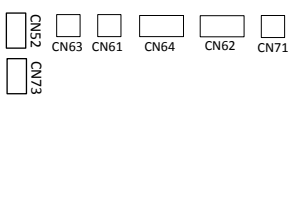
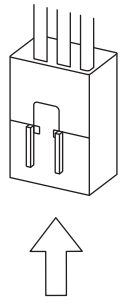
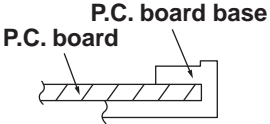
| No. | Part name | Procedure | Remarks |
|-----|------------------------|--|---|
| ④ | Control board assembly | <p>1. Disconnect the leads and connectors connected to the other parts from the control board assembly.</p> <p>1) Leads</p> <ul style="list-style-type: none"> • 3 leads (black, white, orange) connected to terminal block. • Lead connected to compressor : Disconnect the connector (3P). • Lead connected to reactor : Disconnect the two connectors (2P). <p>2) Connectors</p> <p>CN31 : Outdoor fan motor (3P: white)* (* : See Note)</p> <p>CN72 : 4-way valve (2P: yellow)*</p> <p>CN61 : TE sensor (2P: white)*</p> <p>CN73 : PMV (6P: white)</p> <p>CN64 : TS sensor (3P: white)*</p> <p>CN62 :TD sensor (3P: white)*</p> <p>CN63 : TO sensor (2P: white)</p> <p>CN71 : Heater (2P : white)</p> <p>CN52 : High Pressure Switch (2P : white)</p> <div style="border: 1px solid black; padding: 5px; text-align: center; margin: 10px 0;">NOTE</div> <p>These connectors have a disconnect prevention mechanism: as such, the lock on their housing must be released before they are disconnected.</p> <p>2. Remove the control board assembly from the spacer. (Remove the heat sink and control board assembly while keeping them screwed together.)</p> <p>3. Remove the two fixing screws used to secure the heat sink and control board assembly.</p> <p>4. Mount the new control board assembly.</p> <div style="border: 1px solid black; padding: 5px; text-align: center; margin: 10px 0;">NOTE</div> <p>When mounting the new control board assembly, ensure that the P.C. board is inserted properly into the spacer support.</p> |  <p>CN31, CN72, CN61, CN73, CN64, CN62, CN63, CN52 and CN71 are connectors with locking mechanisms: as such, to disconnect them, they must be pressed in the direction of the arrow while pulling them out.</p>  <p style="text-align: center;">↑</p>  <p style="text-align: center;">P.C. board base P.C. board</p> |

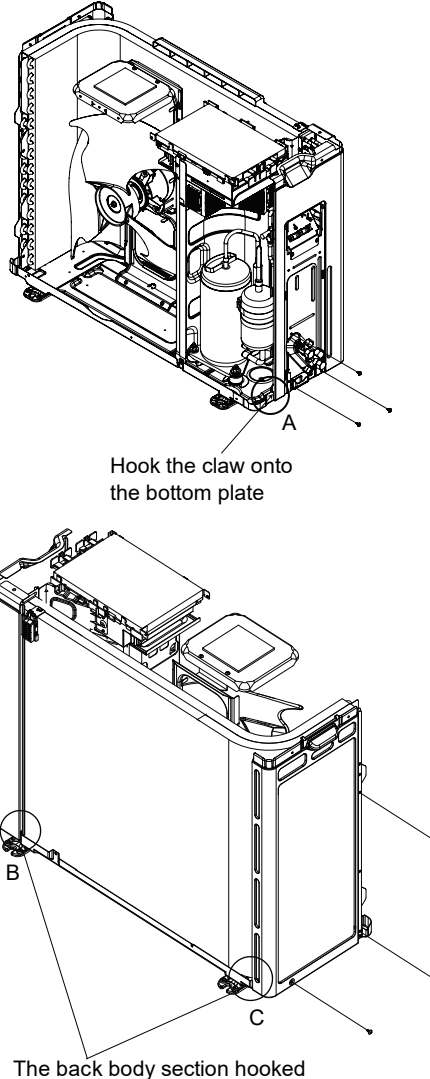
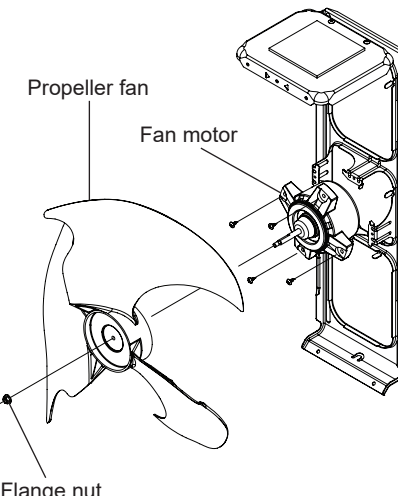
| No. | Part name | Procedure | Remarks |
|-----|--------------|--|---|
| ⑤ | Side cabinet | <p>1. Side cabinet (right)</p> <ol style="list-style-type: none"> 1) Perform step 1 in ② and all the steps in ③. 2) Remove the fixing screw (ST2TØ4 × 10L 3 pcs.) used for securing the side cabinet to the bottom plate and valve fixing panel. <p>2. Side cabinet (left)</p> <ol style="list-style-type: none"> 1) Perform step 1 in ②. 2) Remove the fixing screw (ST2TØ4 × 10L 1 pc.) used to secure the side cabinet (left) onto the heat exchanger. 3) Remove the fixing screw (ST2TØ4 × 10L 2 pcs.) used for securing the side cabinet to the bottom plate and heat exchanger. |  |
| ⑥ | Fan motor | <ol style="list-style-type: none"> 1) Perform work of item 1 of ① and ②. 2) Remove the flange nut fixing the fan motor and the propeller. <ul style="list-style-type: none"> • Flange nut is loosened by turning clockwise. (To tighten the flange nut, turn counterclockwise.) 3) Remove the propeller fan. 4) Disconnect the connector for fan motor from the inverter. 5) Remove the fixing screws (4 pcs.) holding by hands so that the fan motor does not fall. <p>* Precautions when assembling the fan motor Tighten the flange nut using a tightening torque of 4.9 N•m.</p> |  |

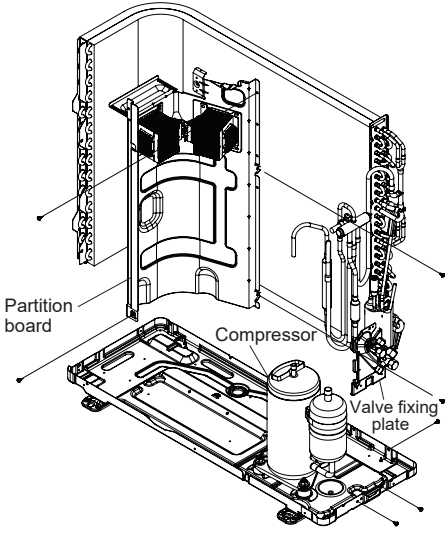
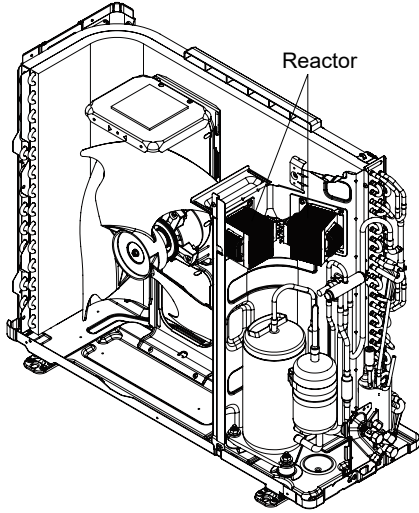
| No. | Part name | Procedure | Remarks |
|-----|------------|---|---|
| ⑦ | Compressor | <ol style="list-style-type: none"> 1) Perform work of item 1 of ① and ②, ③, ④, ⑤. 2) Extract refrigerant gas. 3) Remove the partition board. (ST2TØ4 × 10L 4 pcs.) 4) Remove the sound-insulation material. 5) Remove terminal cover of the compressor, and disconnect lead wire of the compressor from the terminal. 6) Remove pipe connected to the compressor with a burner. <ul style="list-style-type: none"> • Take care to keep the 4-way valve away from naked flames. (Otherwise, it may malfunction.) 7) Remove the fixing screw of the bottom plate and heat exchanger. (ST2TØ4 × 10L 1 pc.) 8) Remove the fixing screw of the bottom plate and valve fixing plate. (ST2TØ4 × 10L 2 pcs.) 9) Pull upward the refrigeration cycle. 10) Remove NUT (3 pcs.) fixing the compressor to the bottom plate. |  |
| ⑧ | Reactor | <ol style="list-style-type: none"> 1) Perform work of item 1 of ②, and ③. 2) Remove screws fixing the reactors. (ST2TØ4 × 10L 4 pcs.) |  |

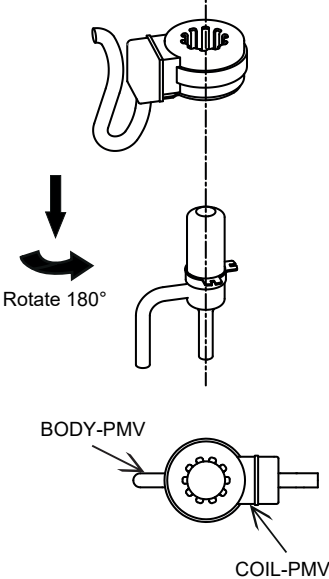
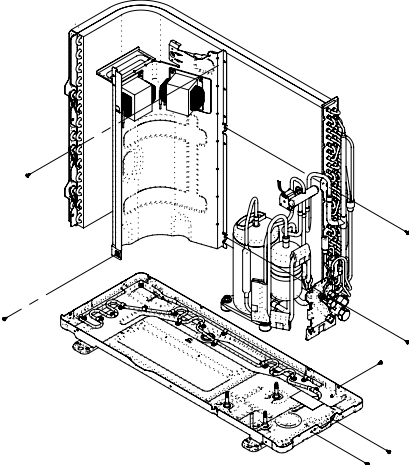
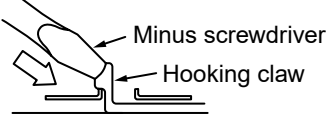
| No. | Part name | Procedure | Remarks |
|-----|---------------------------------|--|--|
| ⑨ | Electronic expansion valve coil | <p>1. Detachment</p> <ol style="list-style-type: none"> 1) Perform step 1 in ②, all the steps in ③ and 1 in ⑤. 2) Remove the coil by pulling it up from the electronic control valve body. <p>2. Attachment</p> <ol style="list-style-type: none"> 1) When assembling the coil into the valve body, ensure that the coil anti-turn lock is installed properly in the pipe. <p><Handling precaution> When handling the parts, do not pull the leads. When removing the coil from the valve body, use your hand to secure the body in order to prevent the pipe from being bent out of shape.</p> |  <p>Rotate 180°</p> <p>BODY-PMV</p> <p>COIL-PMV</p> |
| ⑩ | Heater cord | <p>1. Detachment</p> <ol style="list-style-type: none"> 1) Perform step 1 in ②, all the steps in ③ and ⑤. 2) To replace the new base with heater cord. |  |
| ⑪ | Fan guard | <p>1. Detachment</p> <ol style="list-style-type: none"> 1) Perform work of item 1 of ②. 2) Remove the front cabinet, and put it down so that fan guard side directs downward. <div style="border: 1px solid black; padding: 5px; margin: 10px 0;"> <p>Perform work on a corrugated cardboard, cloth, etc. to prevent flaw to the product.</p> </div> <ol style="list-style-type: none"> 3) Remove the hooking claws by pushing minus screwdriver according to the arrow mark in the right figure, and remove the fan guard. <p>2. Attachment</p> <ol style="list-style-type: none"> 1) Insert claws of the fan guard in the holes of the front cabinet. Push the hooking claws (9 positions) by hands and fix the claws. <div style="border: 1px solid black; padding: 5px; margin: 10px 0;"> <p>Check that all the hooking claws are fixed to the specified positions.</p> </div> |  <p>Minus screwdriver</p> <p>Hooking claw</p> |

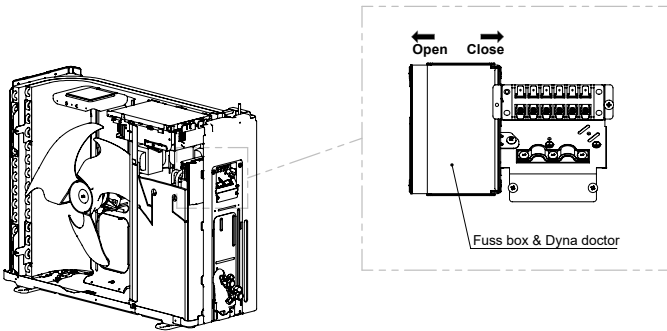
| No. | Part name | Procedures | Remarks |
|-----|---|---|--|
| ⑫ | TE sensor (outdoor heat exchanging temperature sensor) • Attachment | Install the sensor onto the straight pipe part of the condenser output pipe. | |
| ⑬ | TS sensor (Suction pipe temperature sensor) • Attachment | Install the sensor onto the straight pipe part of the suction pipe. Be careful for the lead direction of the sensor. | |
| ⑭ | TD sensor (Discharge pipe temperature sensor) • Attachment | With its leads pointed upward, install the sensor onto the vertical straight pipe part of the discharge pipe. | |
| ⑮ | TO sensor (Outside air temperature sensor) • Attachment | Insert the outdoor air temperature sensor into the holder, and install the holder onto the heat exchanger. | |
| ⑯ | Position Fuse-box & Dyna doctor connecting. |  | <p style="text-align: center;">CAUTION</p> <p>During the installation work (and on its completion), take care not to damage the coverings of the sensor leads on the edges of the metal plates or other parts. It is dangerous for these coverings to be damaged since damage may cause electric shocks and/or a fire.</p> <p style="text-align: center;">CAUTION</p> <p>After replacing the parts, check whether the positions where the sensors were installed are the proper positions as instructed. The product will not be controlled properly and trouble will result if the sensors have not been installed in their proper positions.</p> |

| No. | Part name | Procedure | Remarks | | | | | | | | | | | | | | | | | | | | | | | | | | | | |
|-----|---|---|---------------------|------------|------|---------|---|--------|---|-------------|---|-------------------|---|-----------|---|-------------------|---|-----------|---|---------------------------|---|---------------------|---|------------|---|----------|---|----------|---|--|--|
| ⑰ | <p>Replacement of temperature sensor for servicing only</p> <p>Common service parts of sensor TO, TS, TE, TD</p> <p>These are parts for servicing sensors. Please check that the accessories shown in the right table are packed.</p> | <ol style="list-style-type: none"> 1) Cut the sensor 100 mm longer than old one. 2) Cut the protective tube after pulling out it (200 mm). 3) Move the protective tube toward the thermal sensor side and tear the tip of lead wire in two then strip the covering part. 4) Pass the stripped part through the thermal constringent tube. 5) Cut the old sensor 100 mm length on the connector side, and recycle that connector. 6) Tear the lead wire in two on the connector side and strip the covering part. 7) Twist the leads on the connector and sensor sides, and solder them. 8) Move the thermal constringent tubes toward the soldered parts and heat them with the dryer and constring them. 9) Wind the attached color tape round the both terminals of the protective tube when colored protective tube is used. 10) Fix the sensor again. | | | | | | | | | | | | | | | | | | | | | | | | | | | | | |
| | | <p>NOTE</p> <ol style="list-style-type: none"> 1) Store the joint part of the sensor and the connector in the electric parts box. 2) Never joint them near the thermal sensor part. Otherwise it would cause insulation inferiority because of dew drops. 3) When replacing the sensor using the colored protective tube, wind the color tape matching the color of that tube. | | | | | | | | | | | | | | | | | | | | | | | | | | | | | |
| | | <table border="1"> <thead> <tr> <th></th> <th>Parts name</th> <th>Q'ty</th> <th>Remarks</th> </tr> </thead> <tbody> <tr> <td>1</td> <td>Sensor</td> <td>1</td> <td>Length : 3m</td> </tr> <tr> <td>2</td> <td>Sensor Spring (A)</td> <td>1</td> <td>For spare</td> </tr> <tr> <td>3</td> <td>Sensor Spring (B)</td> <td>1</td> <td>For spare</td> </tr> <tr> <td>4</td> <td>Thermal constringent tube</td> <td>3</td> <td>Including one spare</td> </tr> <tr> <td>5</td> <td>Color tape</td> <td>1</td> <td>9 colors</td> </tr> <tr> <td>6</td> <td>Terminal</td> <td>3</td> <td></td> </tr> </tbody> </table> | | Parts name | Q'ty | Remarks | 1 | Sensor | 1 | Length : 3m | 2 | Sensor Spring (A) | 1 | For spare | 3 | Sensor Spring (B) | 1 | For spare | 4 | Thermal constringent tube | 3 | Including one spare | 5 | Color tape | 1 | 9 colors | 6 | Terminal | 3 | | |
| | Parts name | Q'ty | Remarks | | | | | | | | | | | | | | | | | | | | | | | | | | | | |
| 1 | Sensor | 1 | Length : 3m | | | | | | | | | | | | | | | | | | | | | | | | | | | | |
| 2 | Sensor Spring (A) | 1 | For spare | | | | | | | | | | | | | | | | | | | | | | | | | | | | |
| 3 | Sensor Spring (B) | 1 | For spare | | | | | | | | | | | | | | | | | | | | | | | | | | | | |
| 4 | Thermal constringent tube | 3 | Including one spare | | | | | | | | | | | | | | | | | | | | | | | | | | | | |
| 5 | Color tape | 1 | 9 colors | | | | | | | | | | | | | | | | | | | | | | | | | | | | |
| 6 | Terminal | 3 | | | | | | | | | | | | | | | | | | | | | | | | | | | | | |

13. EXPLODED VIEWS AND PARTS LIST

13-1. Indoor Unit

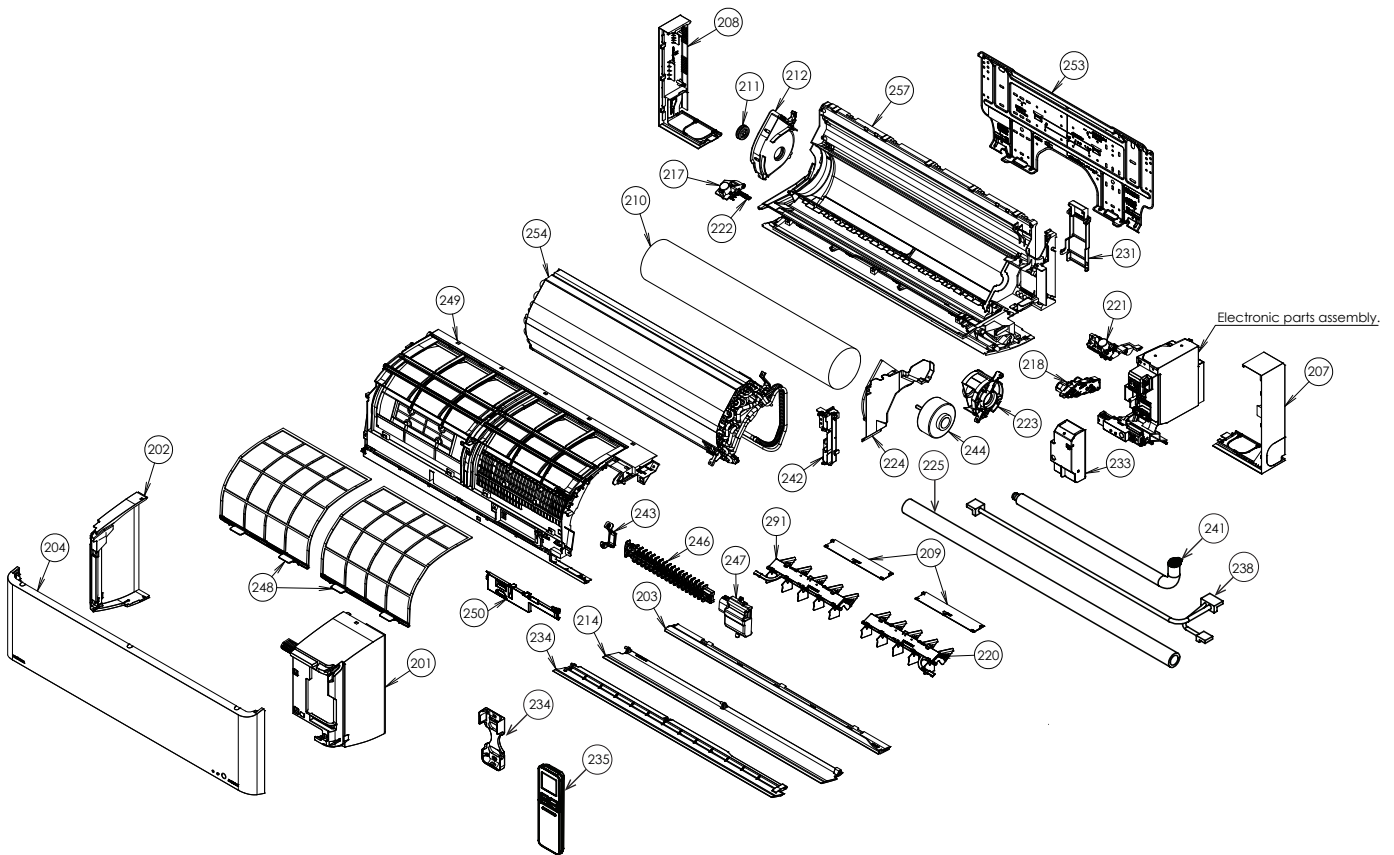

| Location No. | Part No. | Description | Location No. | Part No. | Description |
|--------------|----------|--------------------|--------------|----------|------------------------|
| 201 | 43T00731 | ASM-PANEL(R)-S | 224 | 43039406 | ASM-COV-MOTOR |
| 202 | 43T00732 | ASM-PANEL(L)-S | 225 | 43T11331 | PIPE-SHIELD |
| 203 | 43T00790 | ASM-PANEL(AOLT) | 231 | 43049799 | HOLDER-PIPE |
| 204 | 43T09545 | ASM-AINL-S | 233 | 43T62352 | ASM-COVER-CONN |
| 207 | 43T02306 | ASM-BUSH-BODY(R) | 234 | 43T83305 | HOLDER, REMOTE CONTROL |
| 208 | 43T02307 | ASM-BUSH-BODY(L) | 235 | 43T66376 | WIRELESS REMOCO |
| 209 | 43T04351 | ASM-BODY-BUSH(DN) | 238 | 4306A194 | CORD-MOTOR(LV) |
| 210 | 43020380 | ASM-FAN-CF(CE110) | 241 | 43T70314 | HOSE-DRAIN |
| 211 | 43022466 | ASM-BEAR-MOLD | 242 | 43T63355 | ASM-EARTH |
| 212 | 43022472 | BASE-BEARING | 243 | 43080658 | HOLD-ION |
| 213 | 43022473 | LOUVER-HR(FR) | 244 | 43T21504 | FAN MOTOR |
| 214 | 43022475 | LOUVER-HR(BK) | 246 | 43T80345 | ASM-ION-S |
| 217 | 4302C106 | MOTOR-LOUVER | 247 | 43T80352 | ASM-SUP-HP-S |
| 218 | 43T2D301 | ASM-SUB-GEAR(LV)-S | 248 | 43T80342 | FILTER-AIR |
| 219 | 43T09503 | ASM-LOUVER-VT | 249 | 43T08428 | ASM-FRAME-S |
| 220 | 43T09504 | ASM-LOUVER-VT | 250 | 43T08430 | ASM-COVER-WIFI |
| 221 | 43T2D302 | ASM-GEAR(LV) | 252 | 43082298 | PLATE-INST |
| 222 | 4302D021 | ASM-ARM(L) | 254 | 43T44532 | ASM-CYCLE-REF |
| 223 | 43039404 | BAND-MOTOR | 257 | 43T03411 | ASM-BODY-BACK |

13-2. Indoor Unit (E-Parts Assy)

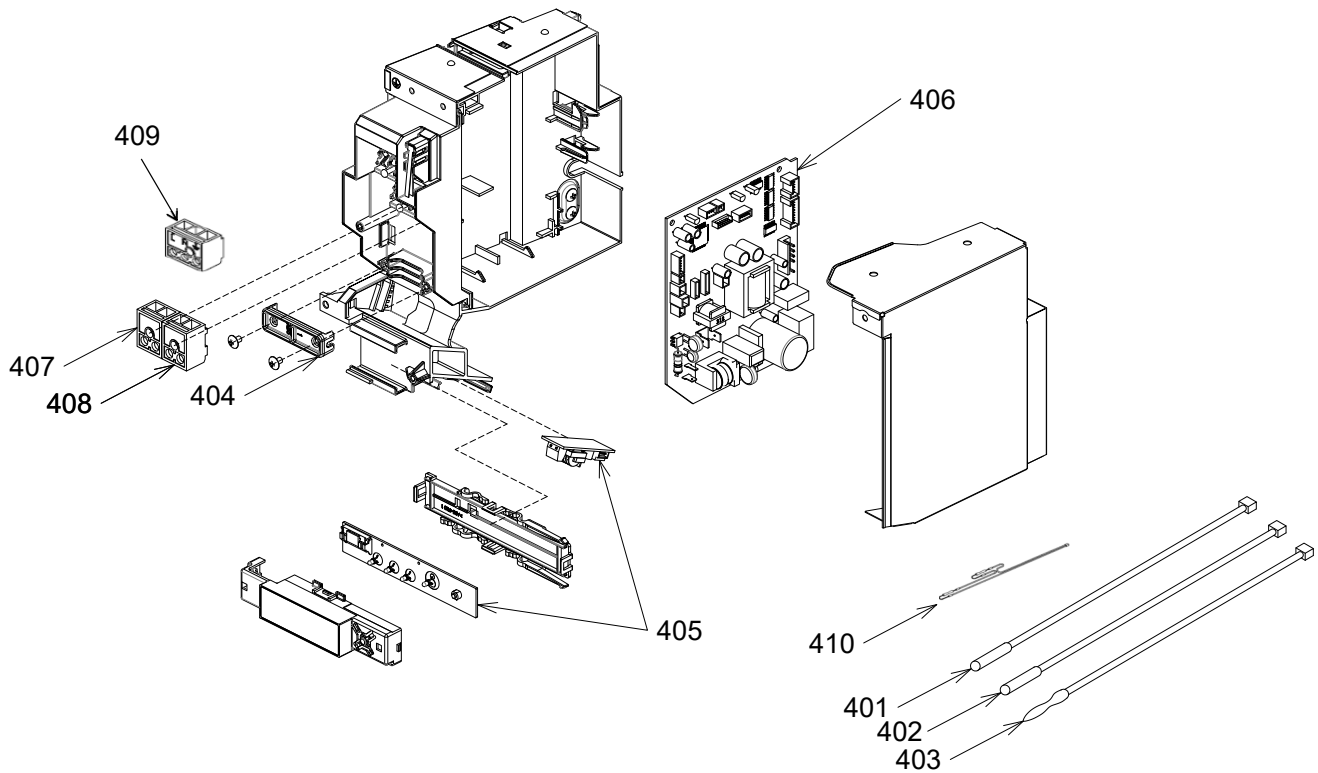

| Location No. | Part No. | Description | Location No. | Part No. | Description |
|--------------|----------|---|--------------|----------|---|
| 401 | 43T50324 | SENSOR; HEAT EXCHANGER | 406 | 43T6W859 | PC BOARD ASSY (MCC-5088) (FOR RAS-35N4KVPG-ND) |
| 402 | 43T50320 | SENSOR HEAT EXCHANGER | 407 | 43T60378 | TERMINAL |
| 403 | 43T50355 | TEMPERATURE SENSOR | 408 | 43T60417 | TERMINAL |
| 404 | 43T62340 | CORD-CLAMP | 409 | 43T60416 | TERMINAL |
| 405 | 43T6V469 | PC BOARD ASSY:WRS-LED | 410 | 43T60077 | FUSE, TEMPERATURE, 73C |
| 406 | 43T6W858 | PC BOARD ASSY (MCC-5088) (FOR RAS-25N4KVPG-ND) | | | |

13-3. Outdoor Unit

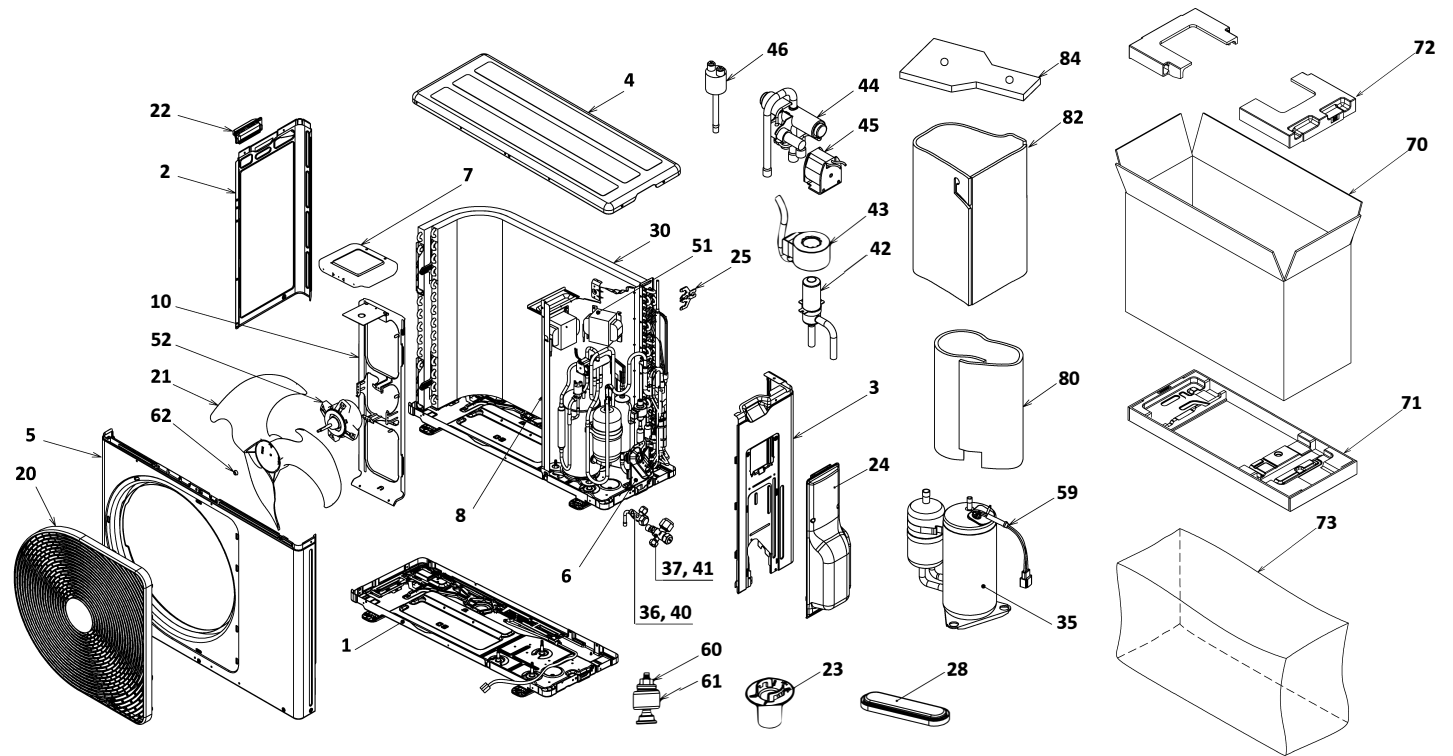

| Location No. | Part No. | Description | Location No. | Part No. | Description |
|--------------|----------|--|--------------|----------|--|
| 1 | 43T42381 | ASM-BASE(WITH HEATER) | 40 | 43T46502 | VALVE ; PACKED 6.35 DIA |
| 2 | 43T00648 | LEFT CABINET | 41 | 43T46503 | VALVE ; PACKED 9.52 DIA |
| 3 | 43T00719 | RIGHT SIDE CABINET ASSEMBLY | 42 | 43T46469 | BODY PMV |
| 4 | 43T00561 | UPPER CABINET | 43 | 43T63360 | COIL PMV |
| 5 | 43T00718 | FRONT CABINET | 44 | 43T46375 | 4 WAY VALVE |
| 6 | 43T00448 | FIXING PLATE VALVE | 45 | 43T63337 | 4 WAY VALVE COIL ASSEMBLY |
| 7 | 43T39341 | MOTOR BASE CONNECTION PLATE | 46 | 43T63379 | SWITCH PRESSURE |
| 8 | 43T04350 | PARTITION ASSEMBLY | 51 | 43T58306 | REACTOR |
| 10 | 43T39374 | MOTOR BASE | 52 | 4302C103 | MOTOR-FAN |
| 20 | 43T19371 | FAN GUARD | 59 | 43T60497 | LEAD ASSY, COMPRESSOR |
| 21 | 43T20331 | PROPELLER FAN | 60 | 43T97001 | NUT |
| 22 | 43T19350 | HANDLE | 61 | 43T49335 | RUBBER CUSHION |
| 23 | 43T79324 | DRAIN NIPPLE | 62 | 43T47001 | NUT FLANGE |
| 24 | 43T00762 | PACKED-VALVE COVER ASSEMBLY | 70 | 43T91336 | CARTON-BOX |
| 25 | 43T63376 | HOLDER, SENSOR | 71 | 43T91381 | FIBERBOARD UNDER ASSEMBLY (FOR RAS-25N4AVPG-ND) |
| 28 | 43089160 | WATERPROOF CAP | 71 | 43T91386 | FIBERBOARD UNDER ASSEMBLY (FOR RAS-35N4AVPG-ND) |
| 30 | 43T43641 | CONDENSER ASSEMBLY | 72 | 43T91337 | CUSHION PACKING UPPER |
| 35 | 43T41555 | COMPRESSOR(KTN150D63UFZ3) (FOR RAS-25N4AVPG-ND) | 73 | 43T91341 | PAC-COVER |
| 35 | 43T41556 | COMPRESSOR(KTM180D68UFZ) (FOR RAS-35N4AVPG-ND) | 80 | 43T04357 | SOUND INSULATION(IS) |
| 36 | 43T47403 | BONNET, 6.35 DIA | 82 | 43T04451 | INSULATION SOUND OUTSIDE |
| 37 | 43T47404 | BONNET, 9.52 DIA | 84 | 43T04358 | SOUND INSULATION(UP) |

13-4. P.C. Board Layout

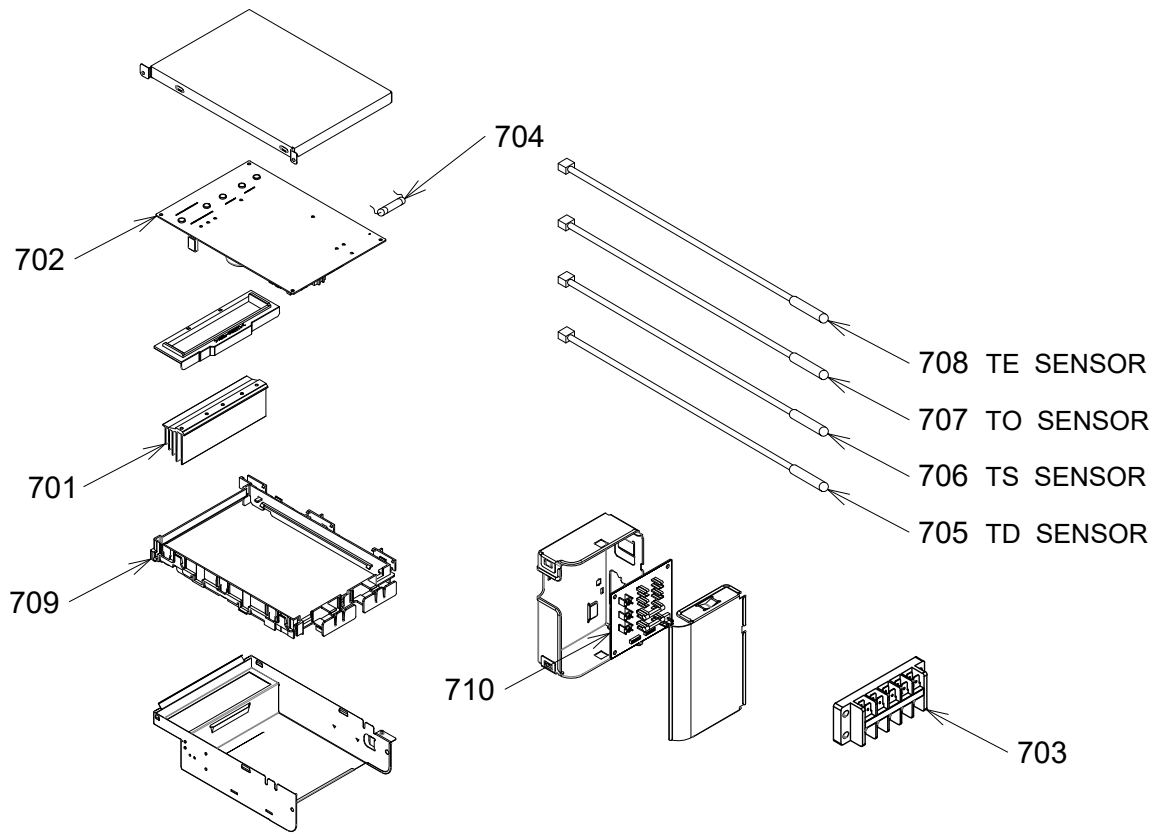

| Location No. | Part No. | Description | Location No. | Part No. | Description |
|--------------|----------|---|--------------|----------|------------------------|
| 701 | 43T62351 | HEATSINK | 705 | 43T50369 | TEMPERATURE SENSOR |
| 702 | 43T6W856 | PC BOARD ASSY (WP-030) (FOR RAS-25N4AVPG-ND) | 706 | 43T50336 | TEMPERATURE SENSOR |
| 702 | 43T6W857 | PC BOARD ASSY (WP-030) (FOR RAS-35N4AVPG-ND) | 707 | 43T50360 | TC-SENSOR(TO) |
| 703 | 43T60384 | TERMINAL-6P | 708 | 43T50371 | TEMPERATURE SENSOR |
| 704 | 43T60326 | FUSE | 709 | 43T62313 | PC PLATE BASE |
| | | | 710 | 43T6W860 | PC BOARD ASSY (WP-505) |

Toshiba Carrier (Thailand) Co., Ltd.

**144/9 MOO 5, BANGKADI INDUSTRIAL PARK, TIVANON ROAD, TAMBOL BANGKADI,
AMPHUR MUANG, PATHUMTHANI 12000, THAILAND.**